

KP-46XBR35 / 53XBR35 / 61XBR38

RM-Y114A

SERVICE MANUAL

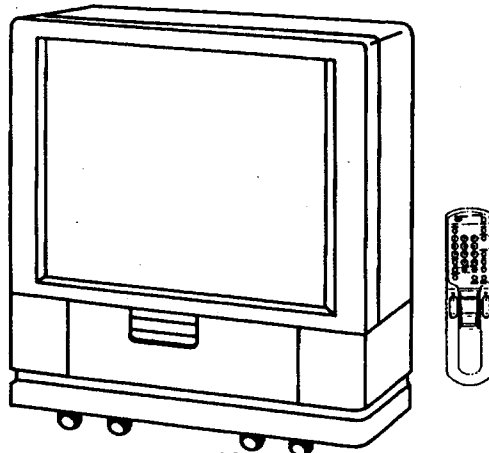

Photo : KP-61XBR38

US Model

KP-46XBR35

Chassis No. SCC-F19R-A

KP-53XBR35

Chassis No. SCC-F19S-A

KP-61XBR38

Chassis No. SCC-F19V-A

Canadian Model

KP-53XBR35

Chassis No. SCC-F23G-A

AP CHASSIS

MODELS OF THE SAME SERIES

KP-46XBR35/53XBR35/61XBR38	KP-46V15/46V16/53V15
KP-46XBR25/53XBR25/61XBR28	KP-53V16/61V15
KP-41EXR95	KP-41EXR96

SPECIFICATIONS

Structure	Screen and projector, rear projection type	Television system	American TV standards
Projection system	3 picture tubes, 3 lenses, horizontal in-line system	Channel coverage	VHF: 2-13 UHF: 14-69 CABLE TV: 1-125
Picture tube	7 inch high-brightness monochrome tubes (5.5 raster size), with optical coupling and liquid cooling system	Antenna input jacks	75-ohm external antenna terminal for VHF/UHF VIDEO IN 1, 2 and 3 S VIDEO IN (4-pin mini DIN) Y: 1 Vp-p, 75-ohms unbalanced, sync negative C: 0.286 Vp-p (Burst signal) 75-ohms Video (phono jacks): 1 Vp-p, 75-ohms unbalanced, sync negative Audio (phono jacks): 500 mVrms (100% modulation) Impedance: 47 kilo-ohms
Projection lenses	High performance, larger-diameter hybrid lens F 1.0		
Screen material	Acrylic plastic filter, Acrylic plastic lenticular, Polycarbonate plastic fresnel		
Projected picture size (in inches, measured diagonally)	46 (KP-46XBR35) 53 (KP-53XBR35) 61 (KP-61XBR38)		
Screen brightness (cd/m ²)	1,240 (KP-46XBR35) 970 (KP-53XBR35) 700 (KP-61XBR38)		

- Continued on next page -

COLOR REAR VIDEO PROJECTOR

SONY®



Output jacks	<p>MONITOR OUT S VIDEO MONITOR OUT (4-pin mini DIN) Y:1 Vp-p, 75-ohms unbalanced, sync negative Video (phono jacks):1Vp-p, 75-ohms unbalanced, sync negative Audio (phono jacks):500mVrms (100% modulation) Impedance:10 kilo-ohms</p> <p>AUDIO (VAR) OUT (phono jacks) More than 900mVrms (100% modulation) at the maximum volume setting (variable) Impedance:5kilo-ohms</p> <p>AUDIO OUT (phono jacks) 900mVrms (100% modulation) Impedance:5kilo-ohms</p>	<p>Power requirements 120 V AC, 60 Hz Power consumption 350W (max.) 280W (avg.) 7W (standby mode)</p> <p>Dimensions (w/h/d) 1,104×1,289×512 mm (43¹/₂×50³/₄×20¹/₄ inches) (KP-46XBR35) 1,238×1,339×638 mm (48³/₄×52³/₄×25¹/₈ inches) (KP-53XBR35) 1,521×1,532×780 mm (60×60³/₈×30³/₄ inches) (KP-61XBR38)</p> <p>Weight 90.7 kg (200 lb) (KP-46XBR35) 100.5 kg (221 lb 9 oz) (KP-53XBR35) 180.2 kg (397 lb 5 oz) (KP-61XBR38)</p> <p>Supplied accessories Remote Commander RM-Y114A (1) with 2 size AA (R6) EVEREADY batteries</p> <p>Optional accessories U/V mixer EAC-66 Connecting cable RK-74A VMC-810S/820S YC-15V/30V VCR Tray SU-PJT1 (except for KP-61XBR38)</p>
Speaker	<p>KP-46XBR35/53XBR35 Woofer 120 mm (4³/₄ inches) diameter Tweeter 25 mm (1 inches) diameter KP-61XBR38 Woofer 160 mm (6¹/₂ inches) diameter Tweeter 50 mm (2 inches) diameter</p>	
Speaker output CENTER SPEAKER input	<p>20W×2 (FRONT) 10W×2 (REAR) 16Ω NORM. 30W MAX 50W</p>	

Design and specifications are subject to change without notice.

(CAUTION)

SHORT CIRCUIT THE ANODE OF THE PICTURE TUBE AND THE ANODE CAP TO THE METAL CHASSIS, CRT SHIELD, OR CARBON PAINTED ON THE CRT, AFTER REMOVING THE ANODE.

WARNING!!

AN ISOLATION TRANSFORMER SHOULD BE USED DURING ANY SERVICE TO AVOID POSSIBLE SHOCK HAZARD, BECAUSE OF LIVE CHASSIS.

THE CHASSIS OF THIS RECEIVER IS DIRECTLY CONNECTED TO THE AC POWER LINE.

SAFETY-RELATED COMPONENT WARNING !!

COMPONENTS IDENTIFIED BY SHADING AND MARK Δ ON THE SCHEMATIC DIAGRAMS, EXPLODED VIEWS AND IN THE PARTS LIST ARE CRITICAL TO SAFE OPERATION. REPLACE THESE COMPONENTS WITH SONY PARTS WHOSE PART NUMBERS APPEAR AS SHOWN IN THIS MANUAL OR IN SUPPLEMENTS PUBLISHED BY SONY. CIRCUIT ADJUSTMENTS THAT ARE CRITICAL TO SAFE OPERATION ARE IDENTIFIED IN THIS MANUAL. FOLLOW THESE PROCEDURES WHENEVER CRITICAL COMPONENTS ARE REPLACED OR IMPROPER OPERATION IS SUSPECTED.

(ATTENTION)

APRES AVOIR DECONNECTE LE CAP DE L'ANODE, COURT-CIRCUITER L'ANODE DU TUBE CATHODIQUE ET CELUI DE L'ANODE DU CAP AU CHASSIS METALLIQUE DE L'APPAREIL, OU AU COUCHE DE CARBONE PEINTE SUR LE TUBE CATHODIQUE OU AU BLINDAGE DU TUBE CATHODIQUE.

ATTENTION!!

AFIN D'EVITER TOUT RISQUE D'ELECTROCUTION PROVENANT D'UN CHASSIS SOUS TENSION, UN TRANSFORMATEUR D'ISOLEMENT DOIT ETRE UTILISE LORS DE TOUT DEPANNAGE.

LE CHASSIS DE CE RECEPTEUR EST DIRECTEMENT RACCORDE A L'ALIMENTATION SECTEUR.

ATTENTION AUX COMPOSANTS RELATIFS A LA SECURITE!!

LES COMPOSANTS IDENTIFIES PAR UNE TRAME ET PAR UNE MAPQUE Δ SUR LES SCHEMAS DE PRINCIPE, LES VUES EXPLOSEES ET LES LISTES DE PIECES CONT D'UNE IMPORTANCE CRITIQUE POUR LA SECURITE DU FONCTIONNEMENT. NE LES REMPLACER QUE PAR DES COMPOSANTS SONY DONT LE NUMERO DE PIECE EST INDIQUE DANS LE PRESENT MANUEL OU DANS DES SUPPLEMENTS PUBLIES PAR SONY. LES REGLAGES DE CIRCUIT DONT L'IMPORTANCE EST CRITIQUE POUR LA SECURITE DU FONCTIONNEMENT SONT IDENTIFIES DANS LE PRESENT MANUEL. SUIVRE CES PROCEDURES LORS DE CHAQUE REMPLACEMENT DE COMPOSANTS CRITIQUES, OU LORSQU'UN MAUVAIS FONCTIONNEMENT EST SUSPECTE.

SAFETY CHECK-OUT (US Model Only)

After correcting the original service problem, perform the following safety checks before releasing the set to the customer:

1. Check the area of your repair for unsoldered or poorly-soldered connections. Check the entire board surface for solder splashes and bridges.
2. Check the interboard wiring to ensure that no wires are "pinched" or contact high-wattage resistors.
3. Check that all control knobs, shields, covers, ground straps, and mounting hardware have been replaced. Be absolutely certain that you have replaced all the insulators.
4. Look for unauthorized replacement parts, particularly transistors, that were installed during a previous repair. Point them out to the customer and recommend their replacement.
5. Look for parts which, though functioning, show obvious signs of deterioration. Point them out to the customer and recommend their replacement.
6. Check the line cord for cracks and abrasion. Recommend the replacement of any such line cord to the customer.
7. Check the condition of the monopole antenna (if any).
Make sure the end is not broken off, and has the plastic cap on it. Point out the danger of impalement on a broken antenna to the customer, and recommend the antenna's replacement.
8. Check the B+ and HV to see they are at the values specified. Make sure your instruments are accurate; be suspicious of your HV meter if sets always have low HV.
9. Check the antenna terminals, metal trim, "metallized" knobs, screws, and all other exposed metal parts for AC leakage. Check leakage as described below.

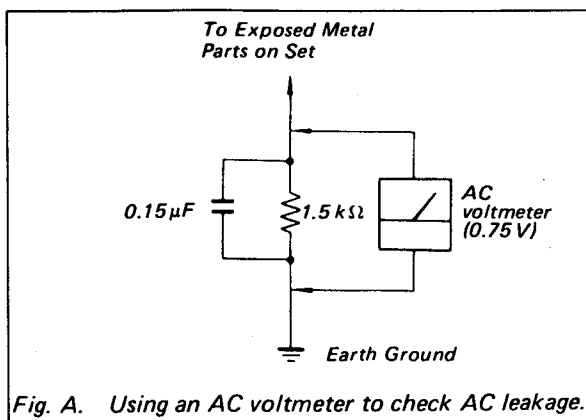

LEAKAGE TEST

The AC leakage from any exposed metal part to earth ground and from all exposed metal parts to any exposed metal part having a return to chassis, must not exceed 0.5 mA (500 microampers). Leakage current can be measured by any one of three methods.

1. A commercial leakage tester, such as the Simpson 229 or RCA WT-540A. Follow the manufacturers' instructions to use these instruments.
2. A battery-operated AC milliammeter. The Data Precision 245 digital multimeter is suitable for this job.
3. Measuring the voltage drop across a resistor by means of a VOM or battery-operated AC voltmeter. The "limit" indication is 0.75 V, so analog meters must have an accurate low-voltage scale. The Simpson 250 and Sanwa SH-63Trd are examples of a passive VOM that is suitable. Nearly all battery operated digital multimeters that have a 2V AC range are suitable. (See Fig. A)

HOW TO FIND A GOOD EARTH GROUND

A cold-water pipe is guaranteed earth ground; the cover-plate retaining screw on most AC outlet boxes is also at earth ground. If the retaining screw is to be used as your earth-ground, verify that it is at ground by measuring the resistance between it and a cold-water pipe with an ohmmeter. The reading should be zero ohms. If a cold-water pipe is not accessible, connect a 60-100 watts trouble light (not a neon lamp) between the hot side of the receptacle and the retaining screw. Try both slots, if necessary, to locate the hot side of the line, the lamp should light at normal brilliance if the screw is at ground potential. (See Fig. B)

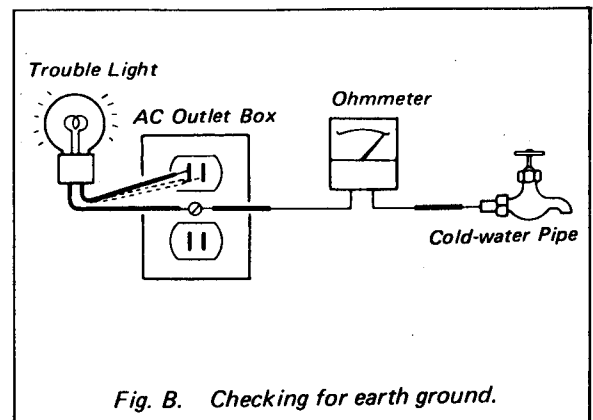

TABLE OF CONTENTS

<i>Section</i>	<i>Title</i>	<i>Page</i>	<i>Section</i>	<i>Title</i>	<i>Page</i>
1. GENERAL			4. SAFETY RELATED ADJUSTMENTS		
1-1.	Unpacking and Viewing Area	5	4-1.	Safety Related Adjustments	60
1-2.	Locating Controls and Controls	5	5. CIRCUIT ADJUSTMENTS		
1-3.	Using the On-Screen Menus	8	5-1.	Electrical Adjustment by Remote Commander	64
1-4.	Adjusting Color Registration(CONVERGENCE)	10	5-2.	A Board Adjustments	66
1-5.	Setting Cable On or Off	11	5-3.	DS Board Adjustments	69
1-6.	Presetting TV Channels	12	5-4.	P2 Board Adjustments	69
1-7.	Watching TV Programs	15	5-5.	P3 Board Adjustments	70
1-8.	Using Closed Caption	16	6. DIAGRAMS		
1-9.	Using Convenient Features	17	6-1.	Block Diagram(1)	72
1-10.	Selecting a Picture and Sound Mode	18	6-2.	Block Diagram(2)	75
1-11.	Watching Two or More Pictures at Once(PIP)	19	6-3.	Block Diagram(3)	79
1-12.	Adjusting the Picture	22	6-4.	Frame Schematic Diagram	83
1-13.	Adjusting the Sound	24	6-5.	Circuit Boards Location	87
1-14.	Customizing the Screen display	27	6-6.	Schematic Diagrams and Printed Wiring Boards	87
1-15.	Using Timer-Activated Functions	29	(1)	Schematic Diagrams of G, H1, H2 and DS Boards	88
1-16.	Setting Favorite Channel	33	(2)	Schematic Diagrams of A Board	97
1-17.	Using Programmable Remote Commander	34	(3)	Schematic Diagrams of U, UT Boards	101
1-18.	Troubleshooting	38	(4)	Schematic Diagrams of E1, E2 Boards	109
2. DISASSEMBLY			(5)	Schematic Diagrams of D Board	113
2-1.	H2 Board Removal		(6)	Schematic Diagrams of M, N Boards	121
	(KP-46XBR35/53XBR35(US/CND)only)	39	(7)	Schematic Diagrams of X3 Board	125
2-2.	H1 Board Removal		(8)	Schematic Diagrams of Y2 Board	129
	(KP-46XBR35/53XBR35(US/CND)only)	39	(9)	Schematic Diagrams of P4 Board	132
2-3-1.	H1 and H2 Boards Removal (KP-61XBR38 only)	40	(10)	Schematic Diagrams of YA Board	135
2-3-2.	Screen Frame Removal(KP-61XBR38 only)	40	(11)	Schematic Diagrams of YG Board	137
2-4.	D Board Removal	41	(12)	Schematic Diagrams of S, V Boards	139
2-5.	Back Cover Removal	41	(13)	Schematic Diagrams of P2 Board	142
2-6.	YA Board Removal	42	(14)	Schematic Diagrams of P3 Board	145
2-7.	Main Chassis Assy Removal	42	(15)	Schematic Diagrams of CB, CG, CR, ZB, ZG and ZR Boards	148
2-8.	Service Position	43	6-7.	Semiconductors	154
2-9.	P3 Board Removal	45	7. EXPLODED VIEWS		
2-10.	Main Connector Panel Removal	45	7-1-1.	Screen Frame and Control panel	157
2-11.	U and P4 Boards Removal	46	7-1-2.	Screen Frame and Control Panel	158
2-12.	V Board Removal	46	7-2.	Cabinet	159
2-13.	N Bracket Removal	47	7-3.	Chassis	160
2-14.	G Board Removal	47	7-4.	Picture Tube	161
2-15-1.	Connector Cable	48	8. ELECTRICAL PARTS LIST		162
2-15-2.	Connector Cable	48			
2-16.	Chassis Assy Removal	49			
2-17.	Picture Tube Removal	49			
2-18.	High-Voltage Cable Installation and Removal	50			
3. SETUP ADJUSTMENTS					
3-1.	Focus Lens Adjustments	51			
3-2.	Deflection Yoke Position Adjustments	51			
3-3.	2-Pole Magnet Adjustment	52			
3-4.	4-Pole Magnet Adjustment	52			
3-5.	De-Focus Adjustment(BLUE)	52			
3-6.	Green Picture Adjustments	52			
3-7.	Green and Red Registration Adjustments	55			
3-8.	Green and Blue Registration Adjustments	56			
3-9.	Registration Check	57			
3-10.	White Balance Adjustments	57			

SECTION 1 GENERAL

The operating instructions mentioned here are partial abstracts from the Operating Instruction Manual. The page numbers of the Operating Instruction Manual remain as in the manual.

1-1. UNPACKING AND VIEWING AREA

1 Carefully follow the instructions on the outside of the packing carton to unpack the projection TV.

- Notes**
- The supplied accessories are packed in the bottom of the carton. Be sure not to throw them away.
 - Keep the original carton and packing materials to safely transport the projection TV in the future.

2 Check to make sure that the following is included:

Universal Remote Commander RM-Y114A (1)
with 2 size AA (R6) EVEREADY batteries

If the Remote Commander is missing, contact your dealer.

3 Place the projection TV in a cool, dry place where the ventilation openings at the sides are not blocked.

4 Plug the projection TV power cord into an AC 120 volt power outlet.

For further precautions, see p. 2.

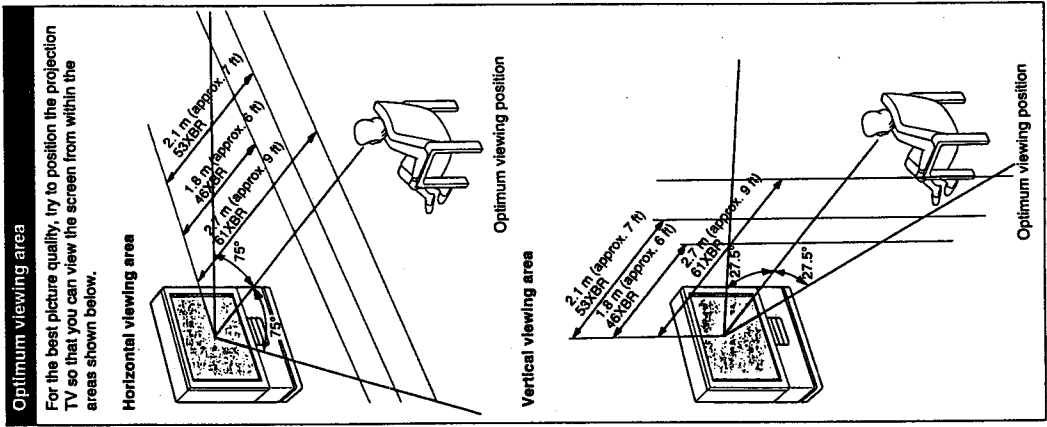

1-2. LOCATING CONTROLS AND CONNECTORS

For details, see the pages indicated by the numbered black circles.

Front

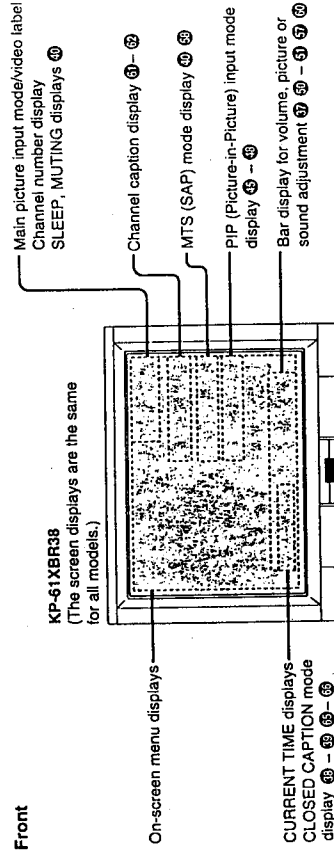

KP-61XBR38

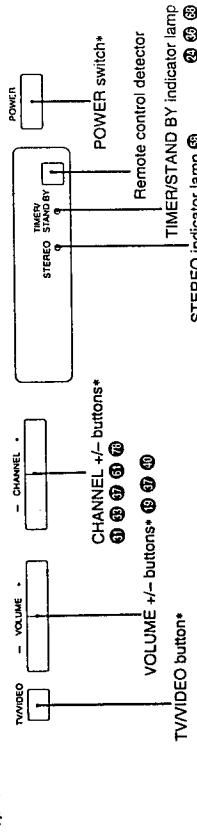

KP-46XBR35/53XBR35

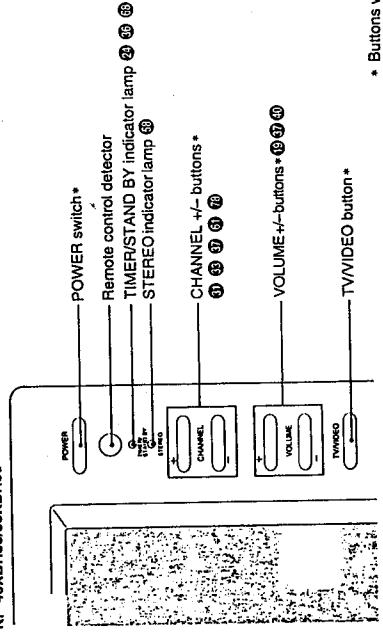

* Buttons with the same function are also located on the Remote Commander (p. 10).

Front inner panel

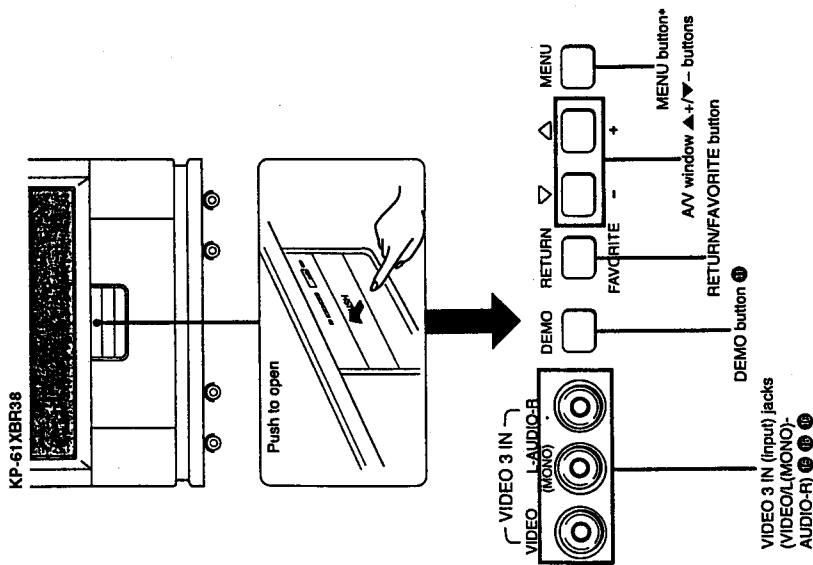

* Buttons with the same function are also located on the Remote Commander (p. 10).

Note
The instructions in this manual are based for the most part on operating the projection TV with the Remote Commander. You can also use the buttons on the projection TV that have the same function.

The following are controls that are of different types, but have exactly the same function.

Projection TV	AV window ▲/▼- buttons	RETURN button
Remote Commander	Rocker control (press up or down)	Rocker control (click)

Rear

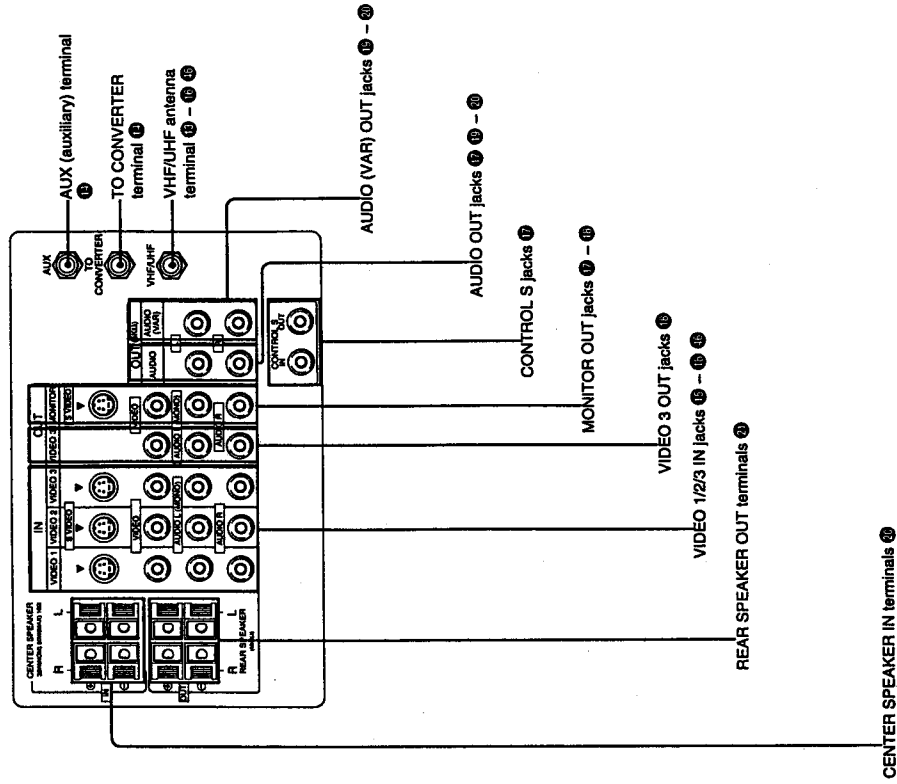

Remote Commander RM-Y114A (Outer panel controls)

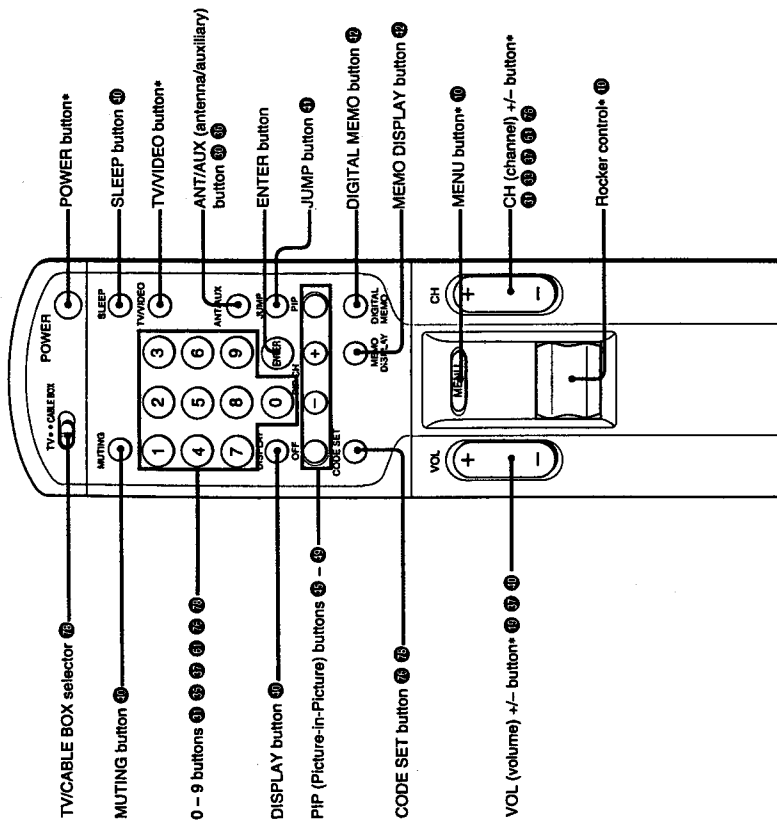

Using the rocker control

Use the rocker control to make on-screen menu selections (see p. 22).

Press the control up or down to make a selection.

Click the control to execute the selection.

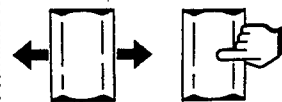

Remote Commander RM-Y114A (inner panel controls)

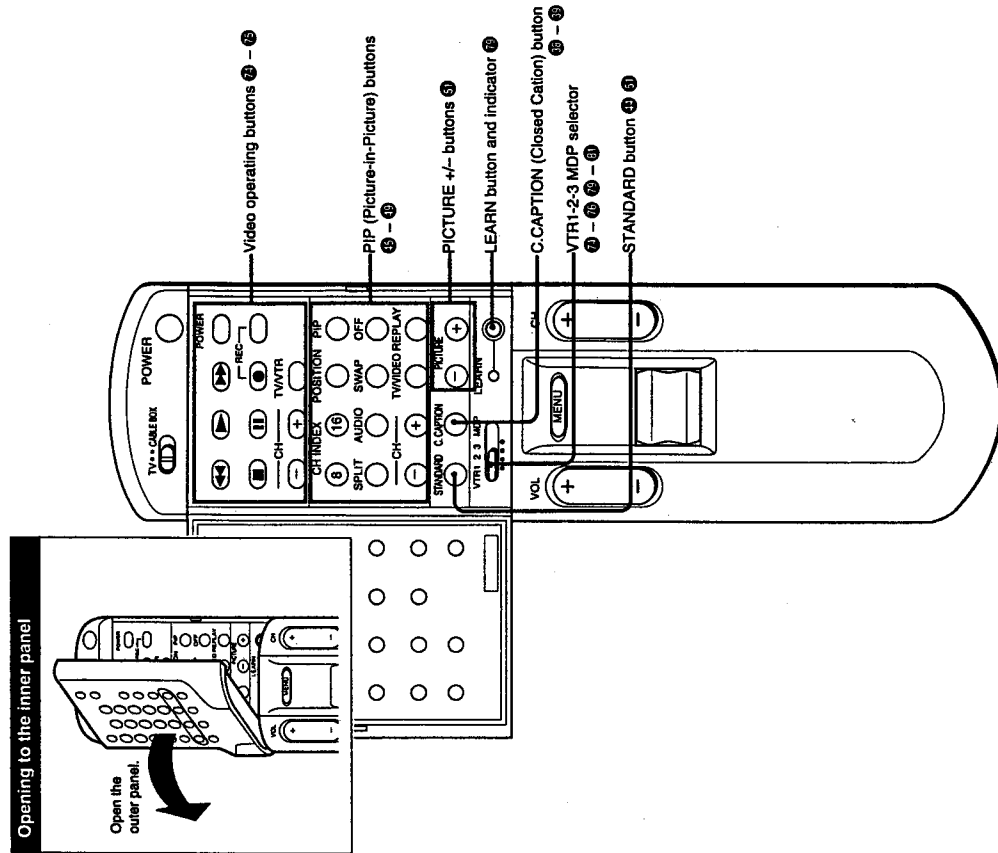

Opening to the inner panel

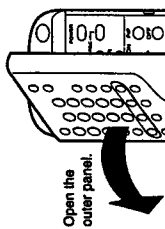

* Buttons with the same function are also located on the projection TV (pp. 7 - 8).

Note
If the TV/CABLE BOX selector is set to CABLE BOX, the Remote Commander is able to control a connected cable box, not the projection TV (p. 74). Set the selector to TV to control the projection TV with the Remote Commander.

1-3. USING THE ON-SCREEN MENUS

The following flow chart shows the different levels of on-screen menus that you can use to make various adjustments and settings. See the indicated pages for instructions on using each feature.

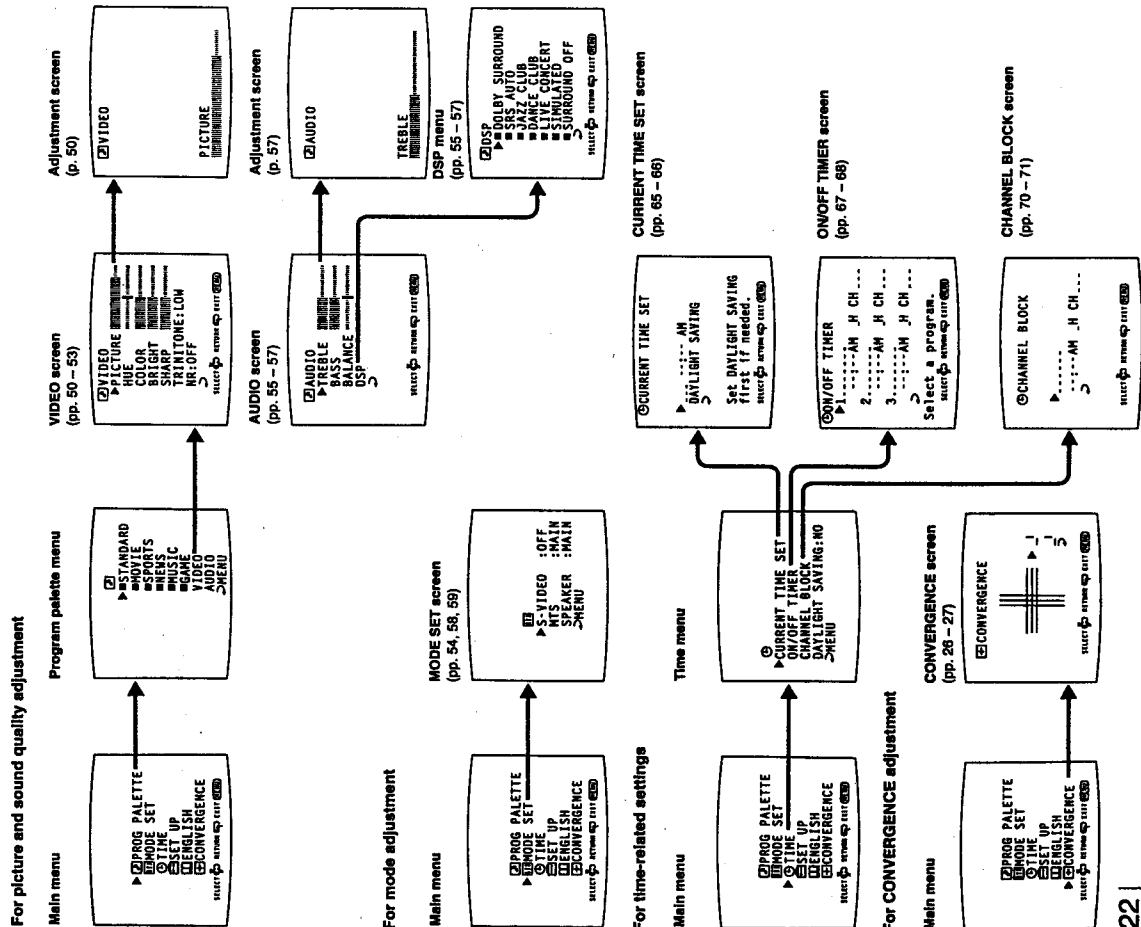

For presetting and other functions

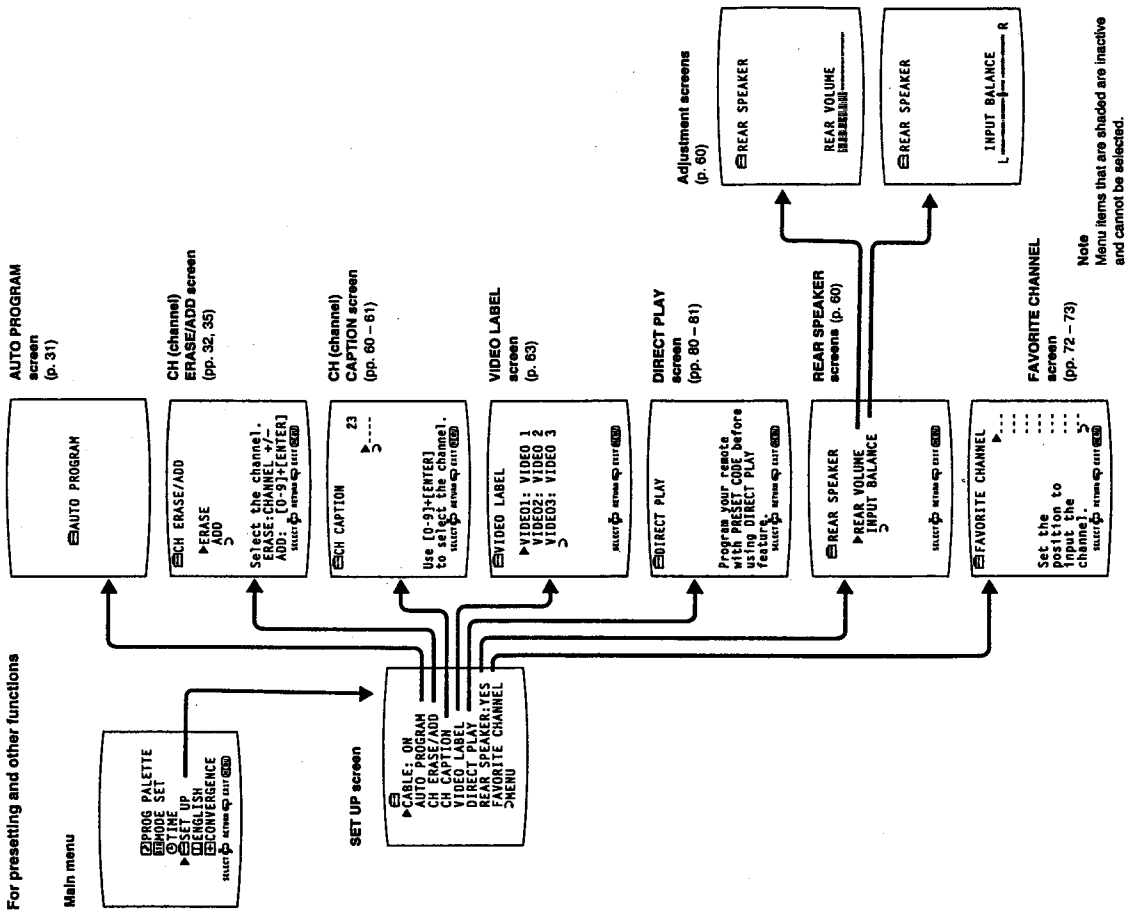

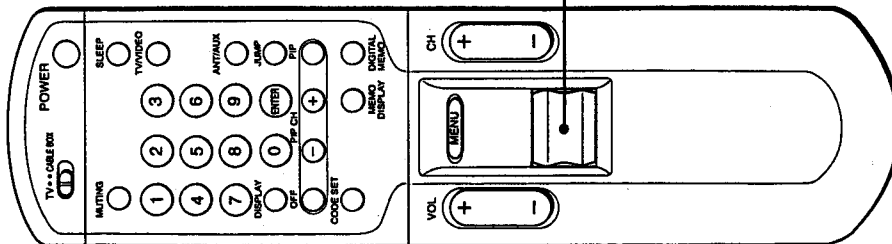

Navigating through the menus

To display the main menu
Press MENU.

To return to the previous menu

Press the rocker control up or down until the cursor points to "MENU."
Then click the rocker control.

To return to the main menu

Repeat the above, until you reach the main menu.

To return to the normal screen

Press MENU on the Remote Commander.

Changing the menu language

The menu language is factory-set to ENGLISH. Follow these instructions to change the menu language to Spanish or French, or back to English.

1 Press POWER to turn on the projection TV.

TIMERSTAND BY indicator blinks until the picture appears.

POWER



2 Press MENU.

The main menu appears.



3 Press the rocker control up or down until the cursor points to "ENGLISH."

Then click the rocker control.

The language display turns red.

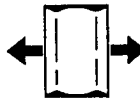

To return to the normal screen.
Press MENU on the Remote Commander.

Notes concerning menus

- During PIP (Picture-in-Picture) mode, the on-screen menus may overlap the window picture.
- The menus disappear automatically, if you do not press a button within 90 seconds.

4 Press the rocker control up or down to select the language.
Each time you press the rocker control up or down, the "ESPAÑOL," "FRANÇAIS" and "ENGLISH" menus appear.

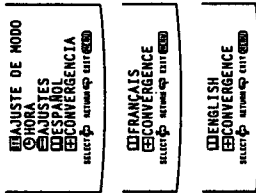
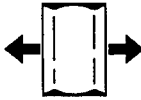

Note

Certain parts of the "ESPAÑOL" and "FRANÇAIS" menus remain in English.

5 Click the rocker control.

The language is selected.

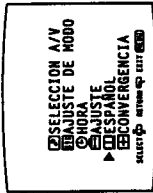

Spanish menu

1-4. ADJUSTING COLOR REGISTRATION (CONVERGENCE)

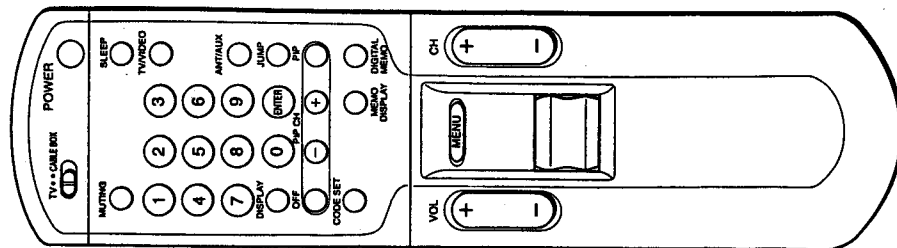

In a projection TV, the projection tube image appears on the screen in three color layers (red, green and blue). If these layers are not in proper registration, the color is poor and the picture blurs. To correct this, perform the CONVERGENCE adjustment.

1 Press MENU.
The main menu appears.

2 Press the rocker control up or down until the cursor points to "CONVERGENCE."

3 Click the rocker control.
The CONVERGENCE screen and the colored adjustment lines appear.

4 Press the rocker control up or down until the cursor points to the symbol representing the line you want to adjust (see the key below).

Adjustment line symbols key
 | (red vertical: left/right adjustment)
 - (red horizontal: up/down adjustment)
 | (blue vertical: left/right adjustment)
 - (blue horizontal: up/down adjustment)

5 Click the rocker control.
The adjustment line is selected.

6 Press the rocker control up or down until the line converges with the center green line. Then click the rocker control.

To move up To move right	Press the rocker control up.
To move down To move left	Press the rocker control down.

7 Repeat steps 4 - 6 to adjust the other lines, until all the lines have overlapped to form a white cross.

To return to the previous menu
Press the rocker control up or down until the cursor points to "MENU."
Then click the rocker control.

To return to the main menu
Repeat the above, until you reach the main menu.

To return to the normal screen.
Press MENU on the Remote Commander.

1-5. SETTING CABLE ON OR OFF

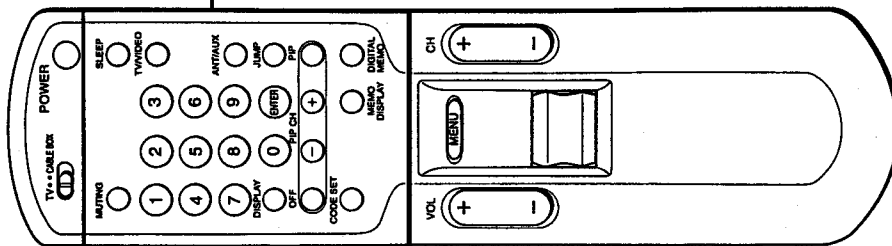

If you have cable connected to the projection TV, follow the steps below to set the cable connection on or off. Set CABLE OFF to preset or watch VHF or UHF channels, and set CABLE ON to preset or watch cable TV channels.

Note
If the projection TV is in video mode, the "CABLE" display is shaded and cannot be selected. Press TV/VIDEO to change to TV mode.

1 Press MENU.
The main menu appears.



2 Press the rocker control up or down until the cursor points to "SET UP."

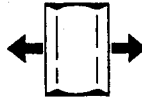

3 Click the rocker control.
The set up menu appears, and the cursor points to "CABLE."

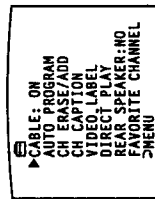

4 Click the rocker control again.
The mode display turns red.

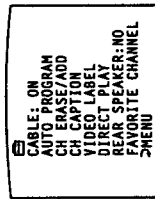

Cable TV channel chart.
Cable TV systems use letters or numbers to designate channels. To tune in a channel, refer to the chart below.

Number on this projection TV	Corresponding CATV channel
1	A-8
5	A-7
6	A-6
14	A
15	B
16	C
17	D
18	E
19	F
20	G
21	H
22	I
23	J
24	K
25	L
26	M
27	N
28	O
29	P
30	Q
31	R
32	S
33	T
34	U
35	V
36	W
37	W+1
38	W+2
39	W+3
...	...
...	...
...	...
93	W+57
94	W+58
95	A-5
96	A-4
97	A-3
98	A-2
99	A-1
100	W+59
101	W+60
102	W+61
...	...
...	...
...	...
123	W+62
124	W+63
125	W+64

5 Press the rocker control up or down to select "ON" or "OFF."

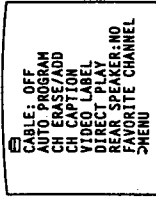
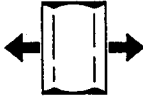

6 Click the rocker control.
The setting is complete.

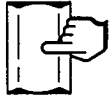

To return to the previous menu
Press the rocker control up or down until the cursor points to "MENU."

Then click the rocker control.

To return to the main menu
Repeat the above, until you reach the main menu.

To return to the normal screen.
Press MENU on the Remote Commander.

Check with your local cable TV company for more complete information on the available channels.
• The designation of the cable TV channels conforms to the EIA/NCCTA recommendation.

1-6. PRESETTING TV CHANNELS

By presetting TV channels to the projection TV, you can select channels by pressing CH (CHANNEL) +/-.
(You can select VHF channels 2 - 13 without presetting.)

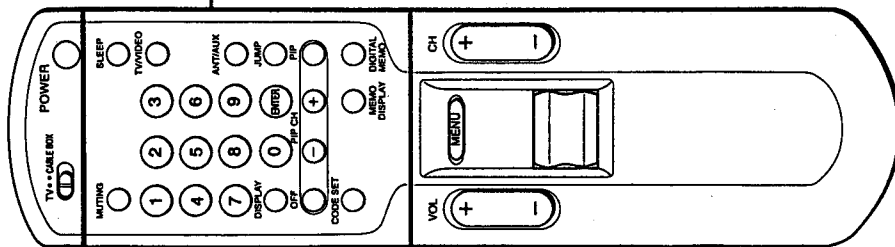

Presetting all receivable channels automatically

Follow these instructions to preset all the receivable VHF, UHF or cable TV channels to the projection TV.

Notes

- If the projection TV is in video mode, the "AUTO PROGRAM" display is shaded and cannot be selected. Press TV/VIDEO to change to TV mode.
- Perform auto programming during the day rather than late at night, when some channels may not be broadcasting.

1 Set the cable connection on or off (pp. 28 - 29) to select the type of channel you want to preset, VHF/UHF or cable TV.

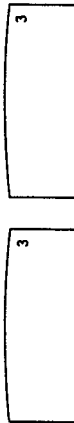

Press ANTI/AUX to select the type of channel you want to preset, VHF/UHF/regular cable TV, or pay cable TV connected to the AUX (auxiliary) terminal.

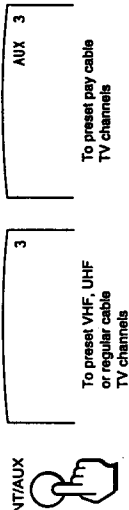

2 Press MENU.
The main menu appears.



▶ CABLE: ON
AUTO PROGRAM
CH ERASE/ADD
CH CAPTION
VIDEO LABEL
DIRECT PLAY
REAR SPEAKER: NO
FAVORITE CHANNEL
▶MENU

3 Press the rocker control up or down until the cursor points to "SET UP."

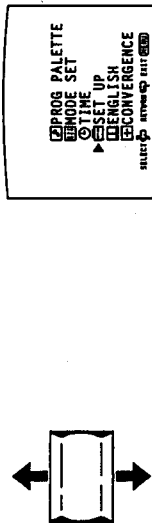

4 Click the rocker control.
The set up menu appears.

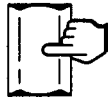

5 Press the rocker control up or down until the cursor points to "AUTO PROGRAM."

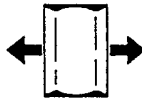

6 Click the rocker control.

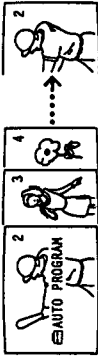

"AUTO PROGRAM" appears on the screen and receivable channels (other than the channels already preset) are preset in numerical sequence. The channels previously preset will not remain in the projection TV's memory.
When no more channels are found, auto programming stops and the screen returns automatically to the set up menu.

7 Press CH +/- to check or view the preset channels.

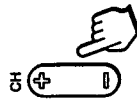

Receivable channels for this projection TV

VHF: 2 - 13
UHF: 14 - 69
Cable: 1 - 125

To select TV channels without presetting
Press the 0 - 9 buttons and ENTER.

To return to the previous menu
Press the rocker control up or down until the cursor points to "▶ MENU."
Then click the rocker control.

To return to the main menu
Repeat the above, until you reach the main menu.

To return to the normal screen.
Press MENU on the Remote Commander.

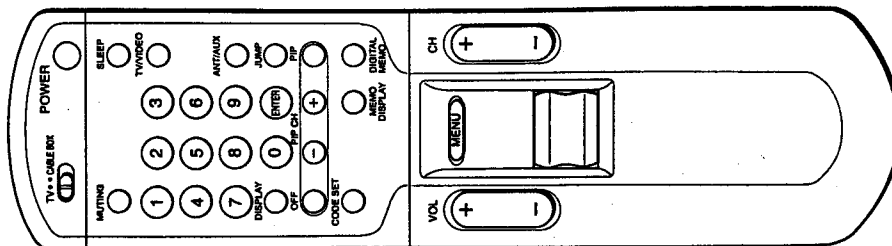

Erasing TV channels

Follow these instructions to erase unnecessary TV channels, so that when you press CH +/-, the channel(s) are skipped.

1 Press MENU.
The main menu appears.



2 Press the rocker control up or down until the cursor points to "SET UP."



3 Click the rocker control.
The set up menu appears.

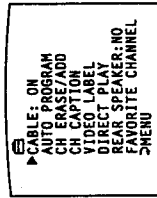

4 Press the rocker control up or down until the cursor points to "CH ERASE/ADD."

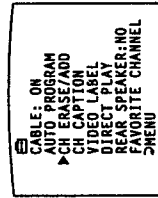

To erase another channel
Repeat steps 6 - 7.

To return to the previous menu
Press the rocker control up or down until the cursor points to "MENU."
Then click the rocker control.

To return to the main menu
Repeat the above, until you reach the main menu.

To return to the normal screen
Press MENU on the Remote Commander.

Note
If you erase a VHF or UHF channel, the same number cable TV channel is also erased (and vice versa).

5 Click the rocker control.
The CH ERASE/ADD screen appears, and the cursor points to "ERASE."

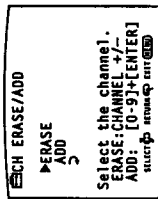

6 Press CH +/- to select the channel you want to erase.
The channel display appears.

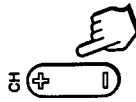
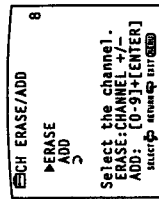

7 Click the rocker control.
A "-" sign appears in front of the channel number display, indicating that the channel is erased; then the CH ERASE/ADD screen automatically reappears.

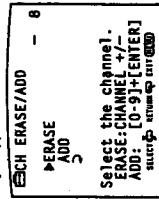

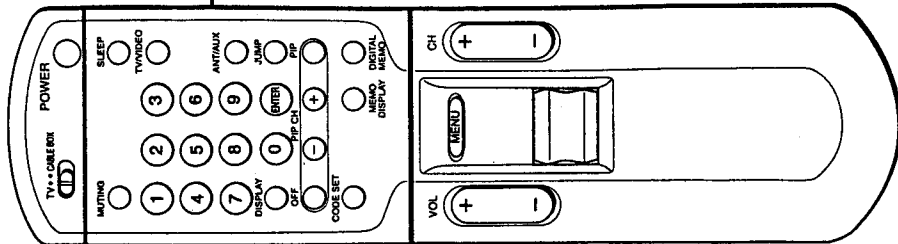



Adding TV channels

Follow these instructions to add TV channels one by one to the selection memory, or to replace a TV channel you previously erased (pp. 32 - 39).

- 1** Press MENU.
The main menu appears.



▶ PROG. PALETTE
MODE SET
TIME SET UP
ENGLISH
CONVERGENCE
- 2** Press the rocker control up or down until the cursor points to "SET UP".



▶ PROG. PALETTE
MODE SET
TIME SET UP
ENGLISH
CONVERGENCE
- 3** Click the rocker control.
The set up menu appears.



▶ CABLE: ON
AUTO PROGRAM
CH ERASE/ADD
UNCAPTION
DIRECT PLAY
REAR SPEAKER: NO
FAVORITE CHANNEL
>MENU
- 4** Press the rocker control up or down until the cursor points to "CH ERASE/ADD".



▶ CABLE: ON
AUTO PROGRAM
CH ERASE/ADD
UNCAPTION
DIRECT PLAY
REAR SPEAKER: NO
FAVORITE CHANNEL
>MENU

- To add another channel**
Repeat steps 7 - 8.
- To return to the previous menu**
Press the rocker control up or down until the cursor points to "MENU."
Then click the rocker control.
- To return to the main menu**
Repeat the above, until you reach the main menu.

To return to the normal screen
Press MENU on the Remote Commander.

Note
If you add a VHF or UHF channel, the same number cable TV channel is also added (and vice versa).

- 5** Click the rocker control.
The CH ERASE/ADD screen appears.



CH ERASE/ADD
ERASE
▶ADD
Select the channel.
ERASE: CHANNEL +/-
ADD: [0-9]+[ENTER]
- 6** Press the rocker control down until the cursor points to "ADD."



CH ERASE/ADD
ERASE
▶ADD
Select the channel.
ERASE: CHANNEL +/-
ADD: [0-9]+[ENTER]
- 7** Press 0 - 9 and ENTER on the Remote Commander to select the channel you want to add.
The channel display appears.

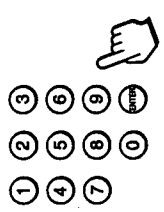

CH ERASE/ADD + 10
ERASE
▶ADD
Select the channel.
ERASE: CHANNEL +/-
ADD: [0-9]+[ENTER]
- 8** Click the rocker control.
A "+" sign appears in front of the channel number display, indicating that the channel is added; then the CH ERASE/ADD screen automatically reappears.



CH ERASE/ADD + 10
ERASE
▶ADD
Select the channel.
ERASE: CHANNEL +/-
ADD: [0-9]+[ENTER]

1-7. WATCHING TV PROGRAMS

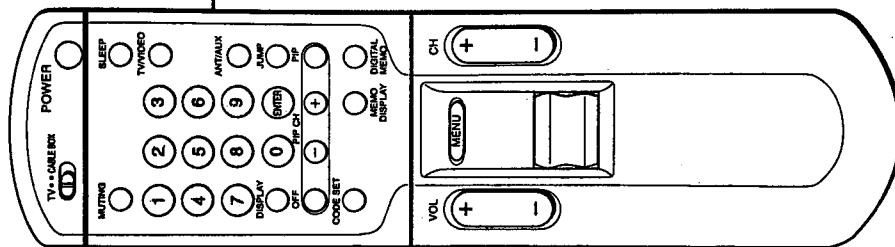

Make sure that the TV/CABLE BOX selector on the Remote Commander is set to TV, in order to control the projection TV with the Remote Commander.

1 Press POWER to turn on the projection TV.
TIMER/STAND BY indicator blinks until the picture appears.

POWER



2 Set the cable connection on or off (pp. 28 - 29) to select the type of channel you want to watch, VHF/UHF or cable TV.

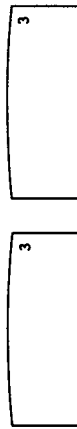

To watch VHF or UHF channels

Press ANT/AUX to select the type of channel you want to watch, VHF/UHF/regular cable TV, or pay cable TV connected to the AUX (auxiliary) terminal.

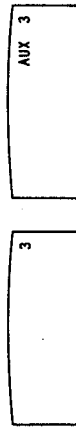

To watch VHF, UHF or regular cable TV channels

ANT/AUX



3 Select a channel in one of the following two ways:

To scan the preset channels in numerical sequence, press CH +/-.

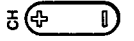

To select a channel directly, press 0 - 9 and then ENTER. For example, to select channel 10, press 1, 0 and ENTER.

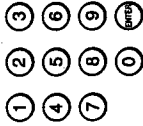

4 Press VOL +/- to adjust the volume.

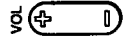

Press + to increase the volume.
 Press - to decrease the volume.

If VIDEO 1, VIDEO 2 or VIDEO 3 appears on the screen

Press TV/VIDEO until a TV channel number appears.

To select channels more easily

Set FAVORITE CHANNEL (pp. 72 - 73).

To turn off the projection TV

Press POWER.

1-8. USING CLOSED CAPTION

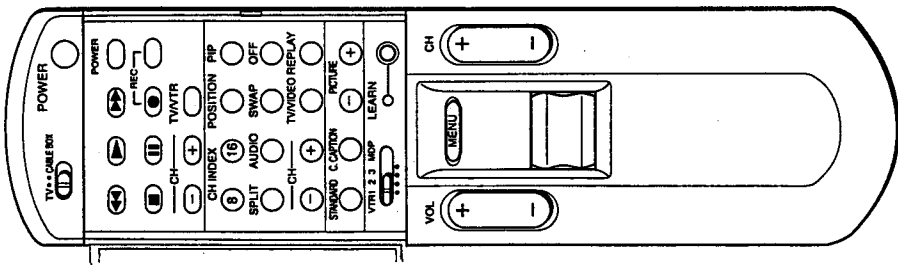

1 Press C.CAPTION.
The closed caption mode appears. CC1, CC2, TEXT1, TEXT2 or CC OFF appears in sequence each time you press C.CAPTION.

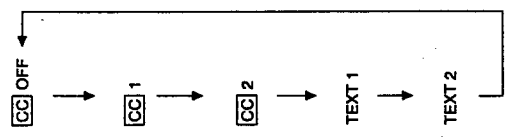
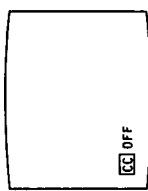

2 Press C.CAPTION repeatedly.



Select CC1 or CC2 to view Captions.
A Caption is a printed version of the dialogue or sound effects of a program. (The mode should be set to CC1 for most programs.)

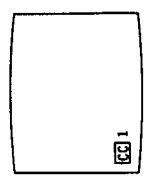

Select TEXT1 or TEXT2 to view Text.
Text is information that is presented using the half to full television screen. It is usually not related to the program.

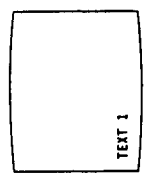

Select CC OFF if you don't want to view Closed Caption nor Text.

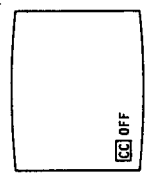

1-9. USING CONVENIENT FEATURES

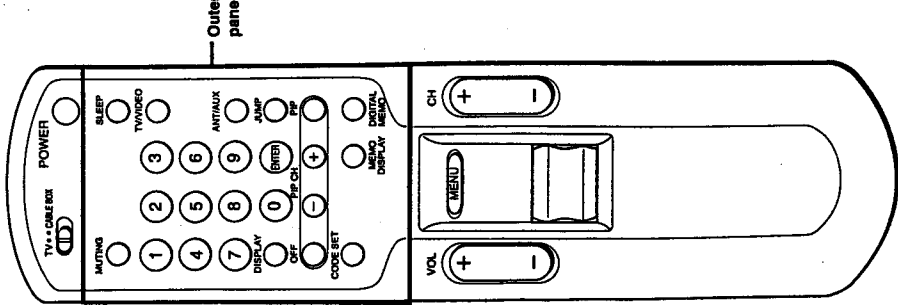
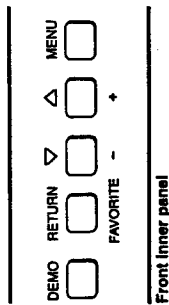

Muting the sound — MUTING

Press **MUTING**.
 "MUTING" appears on the screen.
 To restore the sound
 Press **MUTING** again, or press **VOL +**.



Switching quickly between two channels — JUMP

Use this function to keep track of two programs alternately.
 To recall the channel you were watching previously
 Press **JUMP**.



Keeping the displays on-screen — DISPLAY

Press **DISPLAY**.
 All the existing displays appear: channel number, channel caption (if set), MTS mode ("SAP" only), window picture input mode, and the current time ("AM" or "PM" disappears after about three seconds).



To turn off the displays
 Press **DISPLAY** again.

Setting the sleep timer — SLEEP

The sleep timer turns off the projection TV automatically after the amount of time you select.

Press **SLEEP**.
 Each time you press **SLEEP**, the time increments "30," "60," "90" and "OFF" mode appear in sequence.

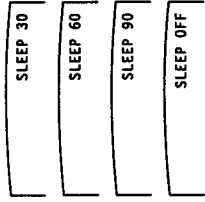

A red "SLEEP" display appears about one minute before the projection TV goes off.

To cancel the setting.
 Press **SLEEP** until OFF mode appears.
 A green "SLEEP OFF" display appears for about three seconds.
 OR
 Turn the projection TV off.
 The sleep timer setting is cancelled.

Previewing the features — DEMO

Press **DEMO** (front inner panel).
 Functions and menus are displayed one by one.



To restart **DEMO** from the beginning
 Press **DEMO** again.

To stop **DEMO**
 Press any button.

1-11. WATCHING TWO OR MORE PICTURES AT ONCE (PIP)

Selecting standard mode (without using the menus)

Follow these instructions to select standard mode without using the on-screen menus.

Press STANDARD.

STANDARD



To return to the previous menu
Press the rocker control up or down until the cursor points to "→ MENU." Then click the rocker control.

To return to the main menu
Repeat the above, until you reach the main menu.

To return to the normal screen.
Press MENU on the Remote Commander.

You can watch both the main picture and one or more window pictures simultaneously, using the Picture-in-Picture (PIP) function.

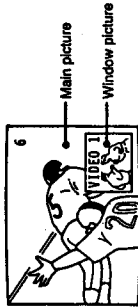

Picture-in-Picture special features

When watching the main picture and a window picture, you can:

- Choose the sound from the main or window picture (AUDIO).
- Change the position of the window picture (POSITION).
- Swap the main and window pictures (SWAP).
- Replay the main picture as a window picture (REPLAY).
- Split the screen, with the main picture on one side and the window picture on the other side (SPLIT).
- Display 8 or 16 TV channels simultaneously (CH INDEX 8/16).

Displaying a window picture

To turn PIP mode on or off, or to change TV channels, you can use the PIP buttons on the Remote Commander's outer panel. For other PIP functions, use the inner panel controls, which also include the PIP, OFF and CH +/- buttons.

Remote Commander (Outer panel)

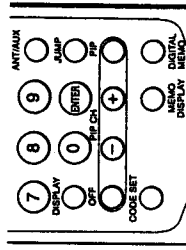

Press PIP to display a window picture

Input source mode or TV channel for the main picture



PIP



Input source mode or TV channel for the window picture



PIP

A window picture appears in the last mode you watched. Each time you press PIP, a 1/4 or 1/8 size window picture appears alternately.

To turn PIP function off
Press OFF.

The window picture disappears.

To change TV channels in the window picture
Press TV/VIDEO to select TV mode; then press CH +/- in the PIP control area.

Notes

- You can also use the CH +/- buttons on the Remote Commander's inner panel.
- The video label and channel caption will not appear with the window picture even if you have set them.
- If you select a blocked channel in the window picture, the display "BLOCKED" appears with the window picture. (See "Setting CHANNEL BLOCK," pp. 70 - 71.)
- If you display a DIGITAL MEMO screen (p. 42), the window picture disappears.

When you select STANDARD mode
You receive standard picture and sound quality. Any video or audio adjustments you made ("Adjusting the Picture" pp. 50 - 54; "Adjusting the Sound" pp. 55 - 60) are cancelled and the original factory settings are restored.

When you select MOVIE mode
You receive a finely detailed picture, and a theatrical audio effect. To further adjust picture and sound qualities, follow the instructions on pp. 50 - 54 and pp. 55 - 60, or select different sound modes from the DSP (Digital Sound Processor) menu (pp. 55 - 56).

When you select SPORTS mode
You receive a vivid, bright picture, and sound with a sports stadium effect. To further adjust picture and sound qualities, follow the instructions on pp. 50 - 54 and pp. 55 - 60, or select different sound modes from the DSP (Digital Sound Processor) menu (pp. 55 - 56).

When you select NEWS mode
Picture noise is reduced, and you receive clear voice reproduction. To further adjust picture and sound qualities, follow the instructions on pp. 50 - 54 and pp. 55 - 60, or select different sound modes from the DSP (Digital Sound Processor) menu (pp. 55 - 56).

When you select MUSIC mode
You receive a warmer picture, and live concert effect sound. To further adjust picture and sound qualities, follow the instructions on pp. 50 - 54 and pp. 55 - 60, or select different sound modes from the DSP (Digital Sound Processor) menu (pp. 55 - 56).

When you select GAME mode
The picture is easier on your eyes, and sound has a surround effect. To further adjust picture and sound qualities, follow the instructions on pp. 50 - 54 and pp. 55 - 60, or select different sound modes from the DSP (Digital Sound Processor) menu (pp. 55 - 56).

Caution
Leaving a fixed pattern on the screen for long periods of time, when operating a video game or personal computer, may damage the picture tube. To avoid this, keep the picture contrast and the brightness levels low (PICTURE and BRIGHT adjustment, pp. 50 - 51).

Changing the window picture input mode

Follow these instructions to select the input mode (TV, VIDEO 1, VIDEO 2, VIDEO 3) for the window picture.

Remote Commander (inner panel)

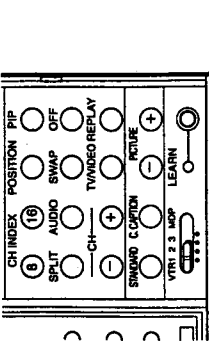

1 Press PIP to display a window picture.



2 Press TVVIDEO to select the input mode. Each time you press TVVIDEO, TV, VIDEO 1, and VIDEO 3 appear in sequence.



To receive the window picture sound Press AUDIO.

The P display appears for a few seconds, indicating that the window picture sound is being received.

To restore the main picture sound Press AUDIO again.

Note The window picture sound is also output from the AUDIO (VAR) OUT jacks. The AUDIO OUT and MONITOR OUT jacks output the main picture sound only.

Displaying CATV input as a window picture

To use Picture-in-Picture with pay cable TV input, make the connections to your cable converter box as shown below.

(Front inner panel)



(Rear of projection TV)

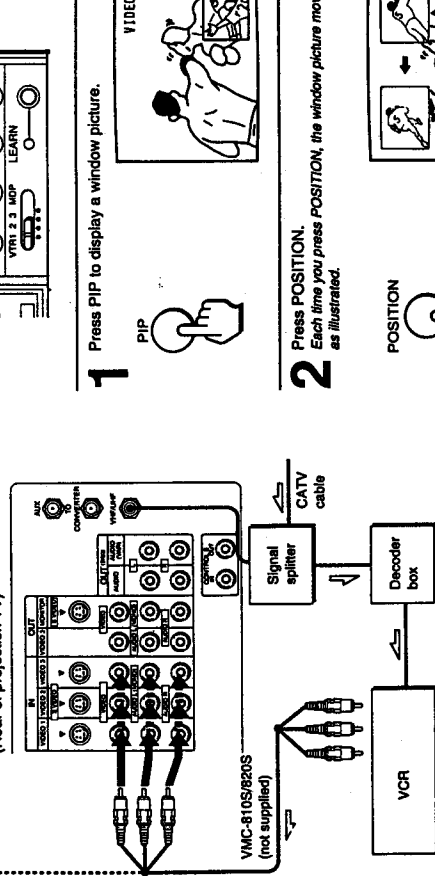

After making the above connections, turn the cable connection on by following the steps on pp. 28 - 29; then continue with the steps below.

1-2 Follow steps 1 - 2 in "Changing the window picture input mode" on this page to select the video input mode for your connected VCR.

3 Put your VCR on an inactive channel (channel 3 or 4).

4 Change pay cable TV channels with the decoder box.

To control your cable converter box with the supplied Remote Commander See p. 78.

Changing the position of the window picture

Follow these instructions to change the position of the window picture on the screen.

Remote Commander (inner panel)

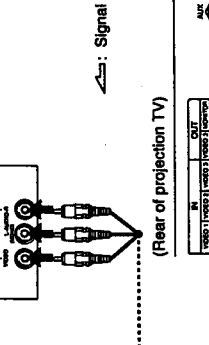

1 Press PIP to display a window picture.

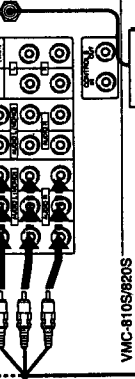

2 Press POSITION. Each time you press POSITION, the window picture moves as illustrated.

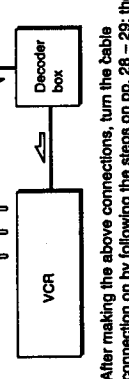

To receive the window picture sound Press AUDIO.

The P display appears for a few seconds, indicating that the window picture sound is being received.

To restore the main picture sound Press AUDIO again.

Note The window picture sound is also output from the AUDIO (VAR) OUT jacks. The AUDIO OUT and MONITOR OUT jacks output the main picture sound only.

Swapping the main and window pictures

Follow these instructions to swap the input signals of the main and window pictures.

Remote Commander (inner panel)

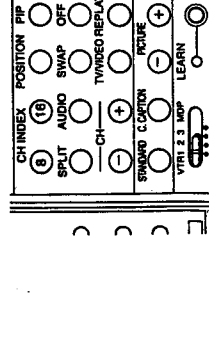

1 Press PIP to display a window picture.



2 Press SWAP. Each time you press SWAP, the images from the main and window pictures switch places.



Displaying 8 TV channels at once – CH INDEX 8

Follow these instructions to display the main picture and 7 window pictures at once.

Remote Commander (inner panel)

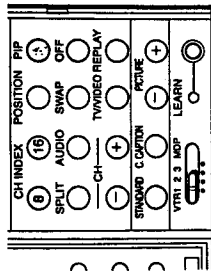

1 Press PIP to display a window picture.



2 Press CH INDEX 8 to display seven window pictures. Seven TV channels appear in numerical sequence, as window pictures.

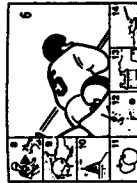

Each time you press CH INDEX 8, the next seven sequential channels appear (the main picture does not change).

To return to the normal screen Press OFF.

Displaying 16 TV channels at once – CH INDEX 16

Follow these instructions to display 16 window pictures at once.

Remote Commander (inner panel)

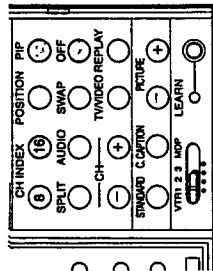

1 Press PIP to display a window picture.



2 Press CH INDEX 16 to display 16 window pictures. 16 TV channels appear in numerical sequence, as window pictures.



Each time you press CH INDEX 16, the next 16 sequential channels appear (the main picture does not change).

To return to the normal screen Press OFF.

Replaying the main picture as a window picture

Follow these instructions to replay the image that appeared in the main picture two seconds before, as a window picture.

Remote Commander (inner panel)

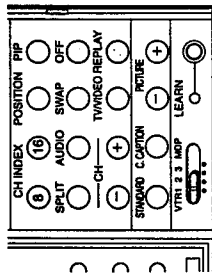

Press REPLAY.



To return to the normal screen Press OFF.

Splitting the screen

Follow these instructions to split the screen, with the window picture on the left, and the main picture on the right.

Remote Commander (inner panel)

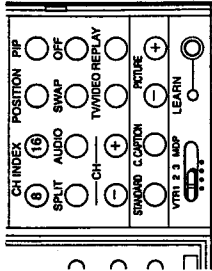

Press SPLIT.



Window picture Main picture

To return to the normal screen Press OFF.

Note When using SPLIT, vertical lines may appear elongated.

Setting the TRINITONE mode

Color picture tubes are usually manufactured with a fixed color temperature (tint) that determines the "warmth" (red tint) or "coolness" (blue tint) of the picture. Use the Sony Trinitone feature to adjust the picture color to your preference.

Remote Commander

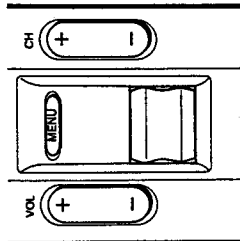

4 Click the rocker control.
The VIDEO screen appears.

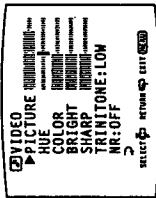

5 Press the rocker control up or down until the cursor points to "TRINITONE."
The mode display turns red.

6 Click the rocker control.
The mode display turns red.

7 Press the rocker control up or down to select "HIGH" or "LOW."
Select "HIGH" to make the picture cool (bluish).
Select "LOW" to make the picture warm (reddish).

8 Click the rocker control.
The setting is complete.

To return to the previous menu
Press the rocker control up or down until the cursor points to "MENU."
Then click the rocker control.

To return to the main menu
Repeat the above, until you reach the main menu.

To return to the normal screen
Press MENU on the Remote Commander.

1 Press MENU.
The main menu appears, and the cursor points to "PROGRAM PALETTE."
The program palette menu appears.



2 Click the rocker control.
The program palette menu appears.

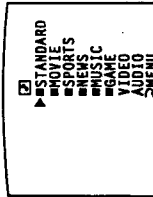

3 Press the rocker control up or down until the cursor points to "VIDEO."
The VIDEO screen appears.

Setting NR (picture noise reduction) ON or OFF
Follow these instructions to reduce picture noise.

Remote Commander

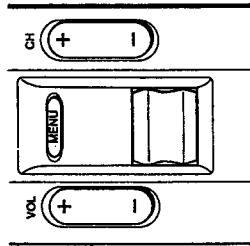

1 Press MENU.
The main menu appears, and the cursor points to "PROGRAM PALETTE."
The program palette menu appears.

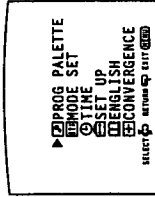

2 Click the rocker control.
The program palette menu appears.

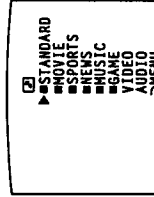

3 Press the rocker control up or down until the cursor points to "VIDEO."
The VIDEO screen appears.

4 Click the rocker control.
The VIDEO screen appears.



5 Press the rocker control up or down until the cursor points to "NR."
The mode display turns red.

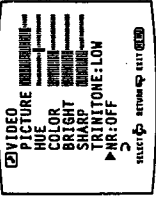

6 Click the rocker control.
The mode display turns red.

7 Press the rocker control up or down to select "ON" or "OFF."
Select "ON" to reduce picture noise.
Select "OFF" to restore the normal picture.

8 Click the rocker control.
The setting is complete.

To return to the previous menu
Press the rocker control up or down until the cursor points to "MENU."
Then click the rocker control.

To return to the main menu
Repeat the above, until you reach the main menu.

To return to the normal screen
Press MENU on the Remote Commander.

1-13. ADJUSTING THE SOUND

Setting S-VIDEO ON or OFF

Follow these instructions to set S-VIDEO on or off, depending on the kind of video equipment you have connected to the projection TV. For instructions on connecting video equipment, see pp. 15 - 18.

Remote Commander (Outer panel)

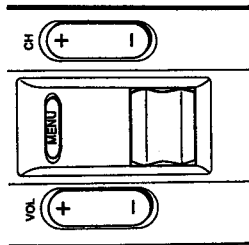

1 Press MENU.
The main menu appears.



2 Press the rocker control up or down until the cursor points to "MODE SET."

3 Click the rocker control.

The mode set menu appears, with the cursor pointing to "S-VIDEO."

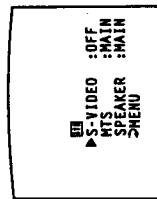

Selecting a sound mode

Use the DSP (Digital Sound Processor) menu to select the sound mode that best suits the type of sound you are listening to.

Example: Select JAZZ CLUB mode to enhance the effect when viewing a musical performance.

Remote Commander

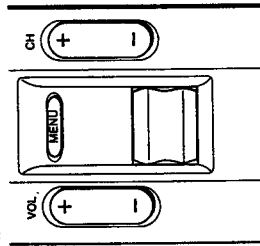

1 Press MENU.
The main menu appears.



2 Press the rocker control up or down until the cursor points to "PROG PALETTE."

3 Click the rocker control.

The program palette menu appears.

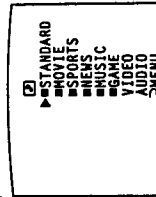

4 Press the rocker control up or down until the cursor points to "AUDIO."

5 Click the rocker control.
The AUDIO screen appears.



6 Press the rocker control up or down until the cursor points to "DSP."

7 Click the rocker control.
The DSP menu appears.

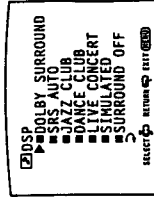

8 Press the rocker control up or down until the cursor points to "JAZZ CLUB."

9 Click the rocker control.
JAZZ CLUB mode is selected.



To select a different mode
Repeat steps 8 - 9. (See the next page for the different modes you can choose.)

To further adjust the sound
Follow the instructions on pp. 57 - 58.

To return to the previous menu
Press AV WINDOW +/- until the cursor points to
• -> MENU.
Then press RETURN.

To return to the main menu
Repeat the above, until you reach the main menu.

To return to the normal screen.
Press MENU on the Remote Commander.

When you select DOLBY SURROUND* mode
You receive wraparound sound with three-dimensional audio depth and presence when you connect main speakers and optional rear speakers.

Note
You must set REAR SPEAKER to "YES" (p. 60), or the display is blacked out and cannot be selected.
When using rear speakers, control the volume with the REAR VOLUME adjustment screen.

When you select SRS AUTO mode
You receive powerfully realistic sound that recaptures audio "clues" originally present but masked in the recording process, so that the action seems to happen all around you.

When you select JAZZ CLUB mode
You receive sound that gives a sense of space, with a touch of echo added.

When you select DANCE CLUB mode
You receive the sound effect of the hard floor and wall environment of a dance club.

When you select LIVE CONCERT mode
You receive sound that simulates the effect of being present at a live concert.

When you select SIMULATED mode
You receive monaural sound with a surround-like effect.

When you select SURROUND OFF mode
You receive sound without a surround effect.

To further adjust sound qualities
Follow the instructions on pp. 57 - 58.

* Manufactured under license from Dolby Laboratories Licensing Corporation. Additionally licensed under one or more of the following patents: U.S. numbers 3,632,886, 3,748,792 and 3,959,590. "Dolby" and the double-D symbol DD are trademarks of Dolby Laboratories Licensing Corporation.

Adjusting sound quality

Follow these instructions to adjust the TREBLE, BASS and BALANCE.

Remote Commander (inner panel)

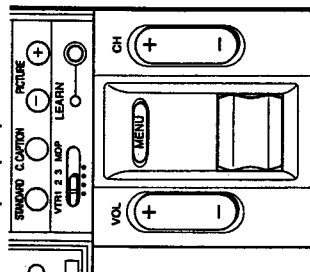

1 Press MENU.
The main menu appears, and the cursor points to "PROG PALETTE."



2 Click the rocker control.
The program palette menu appears.

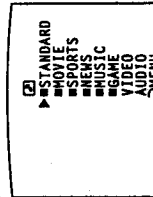

3 Press the rocker control up or down until the cursor points to "AUDIO."

4 Click the rocker control.
The AUDIO screen appears.

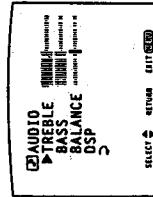

5 Press the rocker control up or down until the cursor points to the item you want to adjust.

6 Click the rocker control.
The adjustment screen appears.

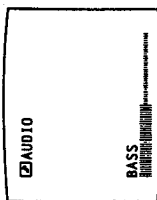

7 Press the rocker control up or down to make the adjustment.

Sound quality	Press the rocker control down	Press the rocker control up
TREBLE	To decrease the treble response	To increase the treble response
BASS	To decrease the bass response	To increase the bass response
BALANCE	To emphasize the left speaker's volume	To emphasize the right speaker's volume

8 Click the rocker control.
The adjustment is complete, and the AUDIO screen automatically reappears.

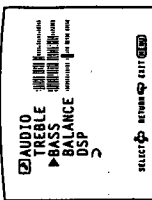

To adjust other items
Repeat steps 5 - 9.

To restore the factory settings for all the items
Select "STANDARD" on the program palette menu, and click the rocker control; or, press STANDARD on the Remote Commander.
All the items return to their original factory settings.

To return to the previous menu
Press the rocker control up or down until the cursor points to "MENU." Then click the rocker control.

To return to the main menu
Repeat the above, until you reach the main menu.

To return to the normal screen
Press MENU on the Remote Commander.

Selecting an MTS (Multichannel TV Sound) mode

Follow these instructions to select an MTS mode.
 Select MAIN mode to listen to stereo sound.
 The STEREO lamp on the projection TV lights up whenever a stereo broadcast is received.
 Select SAP mode to listen to Second Audio Programs.
 Select MONO mode to eliminate excessive noise during stereo broadcasts, caused by a weak incoming signal.

Note
 If the projection TV is in video mode, the "MTS" display is shaded and cannot be selected.
 Press TV/VIDEO on the projection TV or on the Remote Commander to change to TV mode.

Remote Commander (Outer panel)

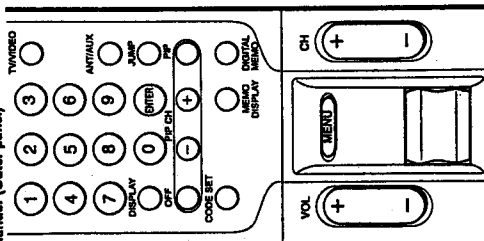

1 Press MENU.
 The main menu appears.



2 Press the rocker control up or down until the cursor points to "MODE SET."

3 Click the rocker control.
 The mode set menu appears.

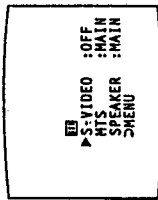

4 Press the rocker control up or down until the cursor points to "MTS."

5 Click the rocker control.
 The mode display turns red.

6 Press the rocker control up or down to select the mode you want.
 Each time you press the rocker control up or down, "MAIN," "SAP" and "MONO" appear in sequence.

7 Click the rocker control.
 The mode is selected.

To return to the previous menu
 Press the rocker control up or down until the cursor points to "MENU." Then click the rocker control.

To return to the main menu
 Repeat the above, until you reach the main menu.

To return to the normal screen
 Press MENU on the Remote Commander.

Setting SPEAKER — MAIN or CENTER

Follow these instructions to set SPEAKER to "CENTER" when you connect an audio system (p.19), and to "MAIN" when you want to listen to the sound from the projection TV speakers.

Remote Commander

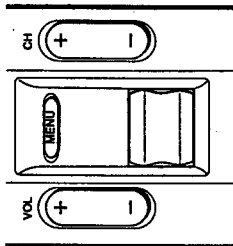

1 Press MENU.
 The main menu appears.



2 Press the rocker control up or down until the cursor points to "MODE SET."

3 Click the rocker control.
 The mode set menu appears

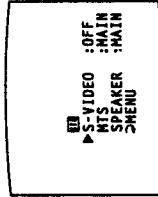

4 Press the rocker control up or down until the cursor points to "MAIN SPEAKER."

1-14. CUSTOMIZING THE SCREEN DISPLAY

Setting REAR SPEAKER

Set REAR SPEAKER to "YES" to use optional speakers as rear speakers (p. 21).

Remote Commander

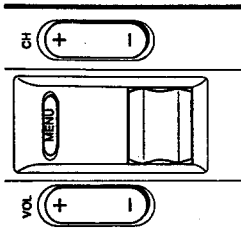

1 Press MENU.
The main menu appears.



2 Press the rocker control up or down until the cursor points to "SET UP."

3 Click the rocker control.
The set up menu appears.

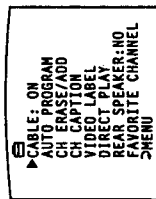

4 Press the rocker control up or down until the cursor points to "REAR SPEAKER."

5 Click the rocker control.
The mode display turns red.

6 Press the rocker control up or down to select "YES."

7 Click the rocker control.
The REAR SPEAKER screen appears.

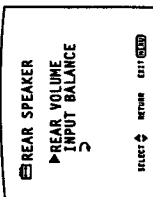

8 Press the rocker control up or down until the cursor points to the item you want to adjust.

9 Click the rocker control.
The adjustment screen appears.



10 Use the rocker control to make the adjustment.

REAR VOLUME

Press the rocker control down to decrease the rear speaker volume.
Press the rocker control up to increase the rear speaker volume.

INPUT BALANCE

Press the rocker control down to improve the input balance. (Set to the lowest point for best input balance.)

Notes

- Setting REAR SPEAKER to "NO" does not turn off the rear speaker sound. Control the rear speaker volume with the REAR VOLUME adjustment.
- While the INPUT BALANCE adjustment screen is displayed, the sound from the front speakers is cut off.

11 Click the rocker control.
The setting is complete.

To set REAR SPEAKER to "NO"

- Repeat steps 1 - 11, and select "NO" in step 6.
- To return to the previous menu
- Press the rocker control up or down until the cursor points to "> MENU." Then click the rocker control.
- To return to the main menu
- Repeat the above, until you reach the main menu.
- To return to the normal screen
- Press MENU on the Remote Commander.

Setting channel captions — CH CAPTION

Follow these instructions to caption each channel number display with a name, for instance, the television station call letters. (You can set up to four letters or numbers).

Example: Caption channel 15 as "NBC."

Remote Commander (Outer panel)

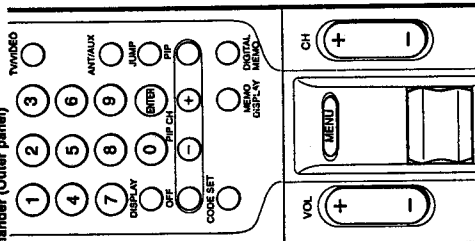

1 Press MENU.
The main menu appears.

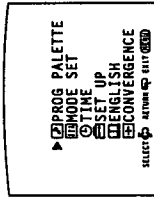

2 Press the rocker control up or down until the cursor points to "SET UP."

3 Click the rocker control.
The set up menu appears.

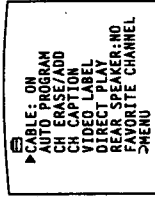

4 Press the rocker control up or down until the cursor points to "CH CAPTION."

5 Click the rocker control.
The CH CAPTION screen appears.

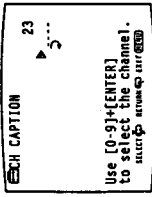

Use [0-9]+[ENTER] to select the channel.

6 Press CH +/-, or press 1, 5 and ENTER to set channel "15."

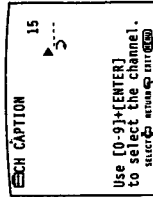

Use [0-9]+[ENTER] to select the channel.

7 Click the rocker control.
The first caption space turns red.

8 Press the rocker control up or down to select "N." Each time you press the rocker control up or down, "0" - "9," "A" - "Z," ".", "-", "/", ":", ":", and "." (blank space) appear in sequence.

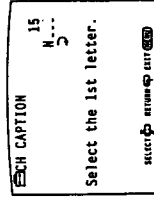

Select the 1st letter.

9 Click the rocker control.
The second caption space turns red.

(Continued)

Setting channel captions - CH CAPTION

(Cont'd. from prev. page)

Remote Commander

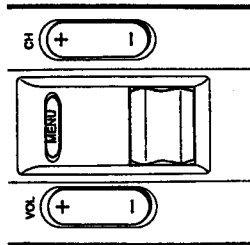

10 Press the rocker control up or down to select "B."

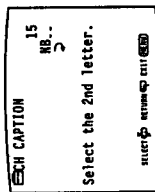

Select the 2nd letter.

11 Click the rocker control.
The third caption space turns red.

12 Press the rocker control up or down to select "C."

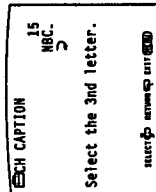

Select the 3rd letter.

13 Click the rocker control.
The fourth caption space turns red.

14 Press the rocker control up or down to select a blank space.

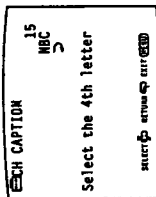

Select the 4th letter

15 Click the rocker control.
The setting is complete.
When you select or display the channel number, the channel caption also appears.

To caption more channels
Repeat steps 6 - 15.

To erase unnecessary captions
Display the CH CAPTION screen, select the channel with the caption you want to erase, and select blank spaces for the channel caption; then click the rocker control.
The caption for that channel is erased.

To return to the previous menu
Press the rocker control up or down until the cursor points to " > MENU."

To return to the main menu
Repeat the above, until you reach the main menu.

To return to the normal screen
Press MENU on the Remote Commander.

Note
You can set up to 32 channel captions. If the memory is full, "The memory is full, sorry" appears on the screen. Erase any unnecessary captions, and begin again.

Setting VIDEO LABEL

Follow these instructions to label each input mode, in order to identify the equipment connected to each input terminal.

Example: Label VIDEO 1 IN as "VHS."

1 Press MENU.
The main menu appears.



2 Press the rocker control up or down until the cursor points to "SET UP."

3 Click the rocker control.
The set up menu appears.

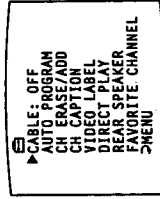

4 Press the rocker control up or down until the cursor points to "VIDEO LABEL."

5 Click the rocker control.
The VIDEO LABEL screen appears.

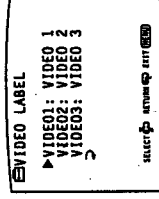

6 Press the rocker control up or down until the cursor points to the input mode you want to label. (In this case, the cursor is already pointing to "VIDEO 1.")

7 Click the rocker control.
The label display turns red.

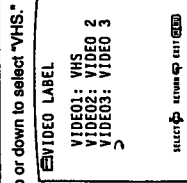

8 Press the rocker control up or down to select "VHS."

Each time you press the rocker control up or down, the label changes:

VIDEO 1 → BETA → 8mm → VHS → LD → S-VIDEO

9 Click the rocker control.
The setting is complete.
When you select or display the video mode, the video label appears.

To label other input modes

Repeat steps 6 - 9.

To change a label
Same as above.

To return to the previous menu

Press the rocker control up or down until the cursor points to " > MENU." Then click the rocker control.

To return to the main menu

Repeat the above, until you reach the main menu.

To return to the normal screen

Press MENU on the Remote Commander.

1-15. USING TIMER-ACTIVATED FUNCTIONS

Setting DAYLIGHT SAVING

If you live in an area that uses daylight savings time, set DAYLIGHT SAVING to "YES" or "NO" depending on the season, before setting the current time. At the next daylight savings date, you will be able to automatically adjust all the time-related settings (CURRENT TIME, ON/OFF TIMER and CHANNEL BLOCK) simply by changing the DAYLIGHT SAVING setting.

When setting DAYLIGHT SAVING:

- After the first Sunday in April (spring daylight savings), set to "NO".
Then, on the last Sunday in October (fall daylight savings), set to "YES".
All the time-related settings automatically move one hour back.
- After the last Sunday in October (fall daylight savings), set to "NO".
Then, on the first Sunday in April (spring daylight savings), set to "YES".
All the time-related settings automatically move one hour ahead.

Remote Commander

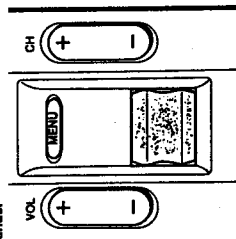

Follow these instructions to set DAYLIGHT SAVING to "YES" or "NO."

- 1 Press MENU.
The main menu appears.

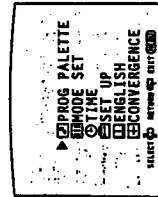

- 2 Press the rocker control up or down until the cursor points to "TIME."

- 3 Click the rocker control.
The time menu appears.

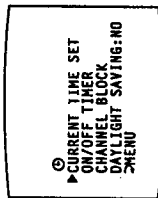

- 4 Press the rocker control up or down until the cursor points to "DAYLIGHT SAVING."

- 5 Click the rocker control.
The mode display turns red.

- 6 Press the rocker control up or down to select "YES" or "NO."
The setting is complete.

- 7 Click the rocker control.

To return to the previous menu
Press the rocker control up or down until the cursor points to "MENU."

Then click the rocker control.

To return to the main menu
Repeat the above, until you reach the main menu.

To return to the normal screen.
Press MENU on the Remote Commander.

Setting the clock — CURRENT TIME SET

Follow these instructions to set the current time. The correct current time must be set in order to use the other time-related functions (DAYLIGHT SAVING, ON/OFF TIMER, CHANNEL BLOCK).

Example: Set the time to 3:15 PM, Monday.

- 1 Press MENU.
The main menu appears.



- 2 Press the rocker control up or down until the cursor points to "TIME."

- 3 Click the rocker control.
The time menu appears, and the cursor points to "CURRENT TIME SET."

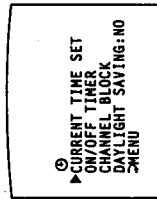

- 4 Click the rocker control again.
The CURRENT TIME SET screen appears, with a reminder to set DAYLIGHT SAVING.

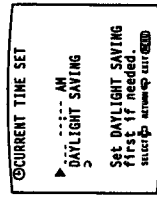

If you do not need to set DAYLIGHT SAVING, click the rocker control and continue from step 5.

To set daylight saving

- a Press the rocker control up or down until the cursor points to "DAYLIGHT SAVING."

- b Click the rocker control.
The time menu appears, and the cursor points to "DAYLIGHT SAVING."

- c Click the rocker control.

- d Press the rocker control up or down to select "YES" or "NO."

- e Click the rocker control.
The setting is complete.

To set the time

Press the rocker control up or down until the cursor points to "CURRENT TIME SET"; click the rocker control, then continue from step 5.

- 5 Click the rocker control.
The CURRENT TIME SET screen appears, and the "SUN" display appears (red).

- 6 Press the rocker control up or down to select "MON." Each time you press the rocker control up or down, the day changes consecutively.

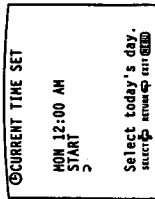

Select today's day.
SELECT

(Continued)

Setting the clock — CURRENT TIME SET

(Cont'd from prev page)

Remote Commander (Outer panel)

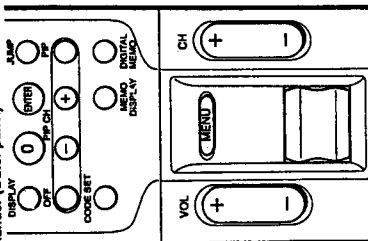

7 Click the rocker control.
The hour and am/pm displays turn red.

8 Press the rocker control up or down to set "3:00PM."
Each time you press the rocker control up or down, the hour changes in sequence beginning with "12:00AM."

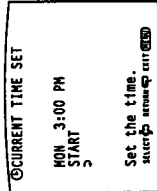

9 Click the rocker control.
The minute display turns red.

10 Press the rocker control up or down to select "15" (minutes).
Each time you press the rocker control up or down, the minutes change in sequence.

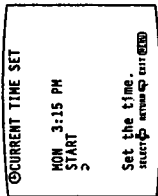

11 Click the rocker control.
The cursor points to "START."

12 Check the actual time, and click the rocker control to start the clock.
The setting is complete.

Setting the ON/OFF TIMER

Follow these instructions to make the program of your choice appear on the screen at a specified time.

Example: Set the timer to turn on the projection TV every Monday through Friday at 1:30 AM for 3 hours, on channel 8, as PROGRAM 1. (You can set up to three programs.)

Remote Commander

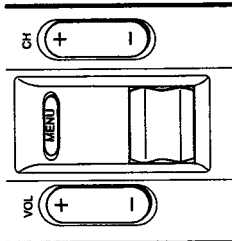

1 Press MENU.
The main menu appears.



2 Press the rocker control up or down until the cursor points to "TIME."

3 Click the rocker control.
The time menu appears.

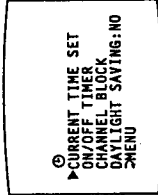

4 Press the rocker control up or down until the cursor points to "ON/OFF TIMER."

5 Click the rocker control.
The ON/OFF TIMER screen appears, and the cursor points to "1."

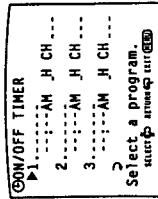

6 To set program 1, click the rocker control.
(To set program 2 or 3, press the rocker control up or down until the cursor points to that program; then click the rocker control.)
The day input space turns red.

7 Press the rocker control up or down to select "EVERY MON-FRI"; then click the rocker control.
Each time you press the rocker control up, the days of the week change as shown in Fig. 1 (p. 67).

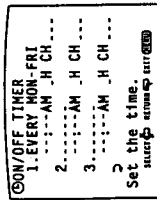

8 Press the rocker control up or down to select "1:00AM"; then click the rocker control.
Each time you press the rocker control up or down, the hour changes in sequence.

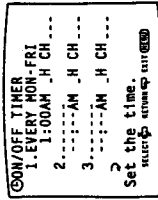

(Continued)

Setting the ON-OFF TIMER (Cont'd from prev. page)

Remote Commander

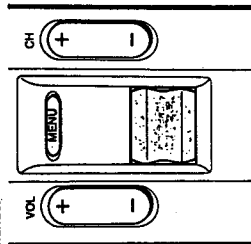

9 Press the rocker control up or down to select "30" (minutes). Then click the rocker control.

Each time you press the rocker control up or down, the minutes change in sequence.

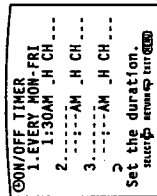

10 Press the rocker control up or down to select "3" (hour duration); then click the rocker control.

Each time you press the rocker control up or down, the duration changes from "1" - "9" in sequence.

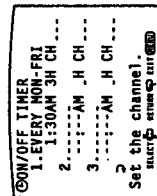

11 Press the rocker control up or down to select "8" (channel); then click the rocker control.

The TIME/STAND BY indicator lights, indicating that the setting is complete. Each time you press the rocker control up or down, the channel number changes from "1" - "125" in sequence.

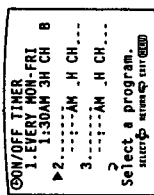

The display "TV WILL TURN OFF" appears on the screen one minute before the timer duration ends.

To set program 2 or 3. Click the rocker control and repeat steps 6 - 11.

To erase an ON/OFF TIMER setting

Display the ON/OFF TIMER screen, select the setting you want to erase, and select the underlined spaces for the day setting.

The ON/OFF TIMER setting is erased.

To enter a new ON/OFF TIMER setting Display the ON/OFF TIMER screen and repeat steps 6 - 11.

To return to the previous menu

Press the rocker control up or down until the cursor points to " > MENU "

Then click the rocker control.

To return to the main menu

Repeat the above, until you reach the main menu.

To return to the normal screen.

Press MENU on the Remote Commander.

Note If you unplug the projection TV or a power failure occurs, both the clock and timer settings will be erased. Reset the current time; then set the timer.

Fig. 1 Selecting the day(s) of the week When you press the rocker control up, the days of the week appear in the following order:

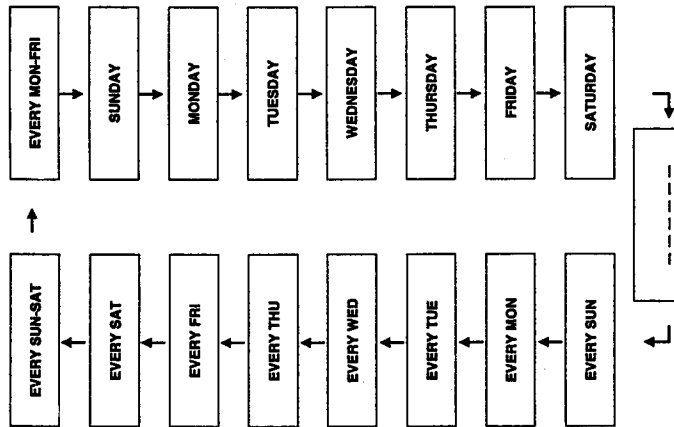

Setting CHANNEL BLOCK

Follow these instructions to prevent a channel from appearing on the screen during the time that you specify. You can use this function to prevent children from watching unsuitable programs.

Example: Set CHANNEL BLOCK every Saturday at 4:30 PM for 1 hour, on Channel 12.

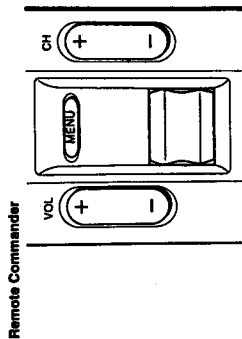

Note
If you have not set the current time, the "CHANNEL BLOCK" display is shaded and cannot be selected.

1 Press MENU.
The main menu appears.



2 Press the rocker control up or down until the cursor points to "TIME."

3 Click the rocker control.
The time menu appears.

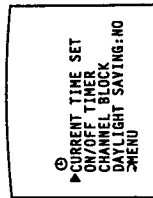

4 Press the rocker control up or down until the cursor points to "CHANNEL BLOCK."

5 Click the rocker control.
The CHANNEL BLOCK screen appears, and the cursor points to the day input space.

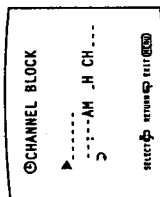

6 Click the rocker control.
The day input space turns red.

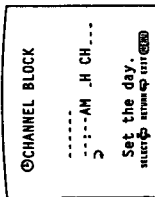

7 Press the rocker control up or down to select "EVERY SAT"; then click the rocker control.
Each time you press the rocker control up or down, the days of the week change as shown in Fig. 1 (p. 67).

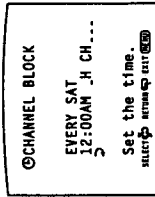

8 Press the rocker control up or down to select "4:00PM"; then click the rocker control.
Each time you press the rocker control up or down, the hour changes in sequence.

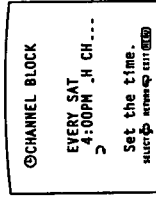

9 Press the rocker control up or down to select "30" (minutes); then click the rocker control.
Each time you press the rocker control up or down, the minutes change in sequence.

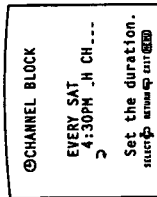

10 Press the rocker control up or down to select "1" (hour duration); then click the rocker control.
Each time you press the rocker control up or down, the duration changes from "1" - "9" in sequence.

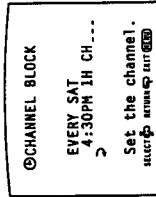

11 Press the rocker control up or down to select "12" (channel); then click the rocker control.
The setting is complete.
Each time you press the rocker control up or down, the channel number changes from "1" - "125" in sequence.

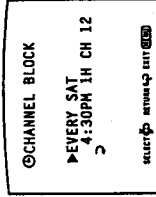

At the specified time, "BLOCKED" appears in red on the screen, and the picture of the specified channel is blocked and the sound is muted.

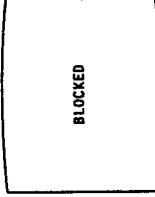

Note
If the ON/OFF TIMER is set for an overlapping time (pp. 67 - 69), the later time setting takes precedence. For example, if CHANNEL BLOCK is set for 2:00 PM and ON/OFF TIMER is set for 3:00 PM, ON/OFF TIMER will take effect at 3:00 PM.

1-16. SETTING FAVORITE CHANNEL

By setting FAVORITE CHANNEL, you can select the channels you use most frequently (up to seven channels) simply by clicking the rocker control on the Remote Commander.

Remote Commander (Outer panel)

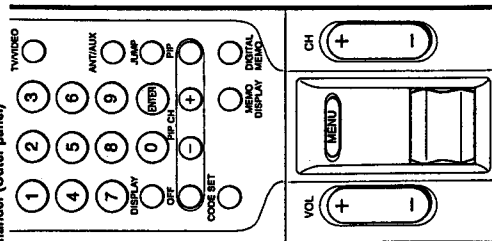

Follow these instructions to set the channels.

1 Press MENU.

The main menu appears.



2 Press the rocker control up or down until the cursor points to "SET UP."

Click the rocker control.
The set up menu appears.

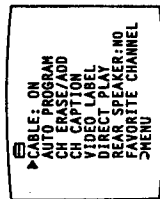

4 Press the rocker control up or down until the cursor points to "FAVORITE CHANNEL."

Click the rocker control.

The FAVORITE CHANNEL screen appears, and the cursor points to the first channel position.

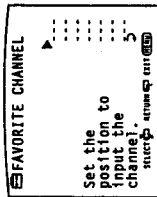

6 Press the rocker control up or down to select the channel position; then click the rocker control.

7 Press 0 - 9 and ENTER to set the channel number.

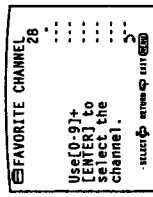

8 Click the rocker control.

The setting is complete.

To set other channels
Repeat steps 6 - 8.

To erase a favorite channel setting
Press the rocker control up or down until the cursor points to the channel number you want to erase; click the rocker control, then press 0 and ENTER.

To reset a favorite channel setting
Display the FAVORITE CHANNEL screen and repeat steps 6 - 8.

To return to the previous menu
Press the rocker control up or down until the cursor points to "MENU." Then click the rocker control.

To return to the main menu
Repeat the above, until you reach the main menu.
To return to the normal screen.
Press MENU on the Remote Commander.

Selecting a favorite channel

After setting the channels, follow these instructions to select the channel you want to watch.

1 Click the rocker control.

The FAVORITE CHANNEL display appears.

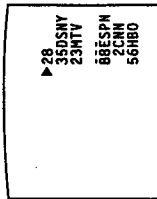

Note
If you have set channel captions (pp. 61 - 62), the captions appear with the channel numbers.

2 Press the rocker control up or down to select the channel you want to watch; then click the rocker control.

The channel is selected.

If you click the rocker control on the Remote Commander before setting FAVORITE CHANNEL, this screen appears.

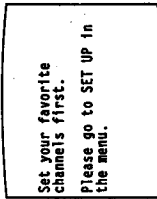

Follow steps 1 - 8 to set your favorite channels, and then make the selection.

1-17. USING THE PROGRAMMABLE REMOTE COMMANDER

You can operate other video equipment (such as VCRs, video disc players and cable boxes) that have an infrared remote detector with this supplied Remote Commander.

Operating Sony video equipment

Follow these instructions to operate Sony video cassette recorders (Beta, 8 mm and VHS) and video disc players (including multi-disc players).

Remote Commander (inner panel)

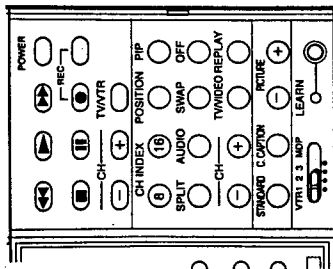

1 Set the VTR1-2-3 MDP selector according to the video equipment you want to operate.



Fig. 2. Video equipment settings

If you want to operate a:	set to:
Beta, ED Beta VCR	VTR 1
8 mm VCR	VTR 2
VHS VCR	VTR 3
Video disc player	MDP

2 Use the video operating buttons to control the connected equipment.

Fig. 3. Operating a VCR (VTR1, 2, 3)

To turn on or off	Press POWER.
To change channels (when watching TV programs through the VCR's tuner)	Press CH +/-.
To record	Press ● and REC simultaneously.
To play	Press ►.
To stop	Press ■.
To fast forward	Press ►►.
To rewind the tape	Press ◄◄.
To pause	Press ■■. To resume normal playback, press again.
To search the picture forward and backward	Keep pressing ►► or ◄◄ during playback. To resume normal playback, release the button.
To change input mode	Press TV/VTR.

Fig. 4. Operating a Video Disc Player (MDP)

To turn on or off	Press POWER.
To play	Press ►.
To stop	Press ■.
To pause	Press ■■. To resume normal playback, press again.
To search the picture forward and backward	Keep pressing ►► or ◄◄ during playback. To resume normal playback, release the button.

Notes

- If the video equipment does not have a certain function, the corresponding button on this Remote Commander will not operate.
- If you set another manufacturer's code to a VTR1-2-3 MDP selector position (pp. 76 - 77), you must also set the Sony code to operate Sony equipment.

Caution

When you replace the batteries, do it within approximately 30 minutes. Otherwise the settings you made under the Pre-Programmed function (pp. 76 - 78) and Learning function (p. 79) may be erased.

Operating non-Sony or Sony video equipment

Follow these instructions to set the manufacturer's code, which will enable you to operate non-Sony and Sony video equipment with the pre-programmed Remote Commander.

Example: Operate an RCA video cassette recorder connected to the VIDEO 2 IN jacks.

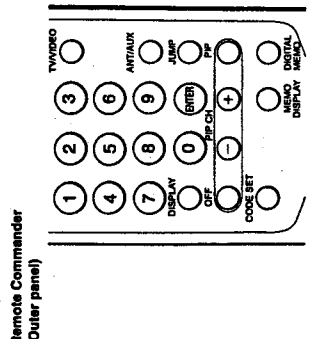

(Inner panel)

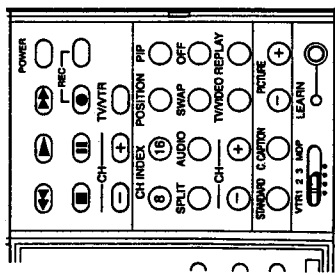

1 Set the VTR1-2-3 MDP selector to VTR2.

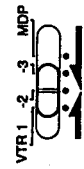

Note
To use another manufacturer's equipment besides a Sony VCR, set the selector to a position not being used for your Sony video equipment.

2 While pressing CODE SET, press 0, 7 and ENTER to set RCA's code number. (For manufacturer code numbers, see Figs. 5, 6 and 7 on p. 77.)

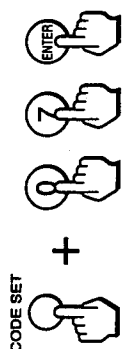

A long beep sounds, indicating that the code has been set.

Note
If you press a wrong code, or if the code has not been set, four short beeps sound. Repeat step 3 to set the code.

3 Use the video operating buttons to operate the connected equipment. (see Fig. 3 on p. 74 and Fig. 4 on p. 75.)

Fig. 5: VCR manufacturer code numbers

MANUFACTURER	CODE
SONY	01, 02, 03
CANON	05
EMERSON	22, 30, 33
FISHER	10, 11, 12, 15
FUNAI	29
GENERAL ELECTRIC	05, 08
GOLDSTAR	25
HITACHI	07, 08, 36
JVC	16, 35
MAGNAVOX	05, 06, 09
MITSUBISHI	18, 19, 26, 27
MULTITECH	29
NEC	16, 23, 31
PANASONIC	05, 08
PHILCO	05, 06
PHILIPS	05, 06, 09
QUASAR	05, 06
RCA	07, 08
SAMSUNG	24, 32
SANYO	11, 15
SCOTT	21
SHARP	13, 14
SHINTOM	34
SYLVANIA	05, 06, 09
SYMPHONIC	29
TEKNIKA	28, 29
TOSHIBA	20, 21
TOTE VISION	25
ZENITH	17

Fig. 7: Sony Equipment and Code Numbers

SONY EQUIPMENT	CODE
Beta, ED Beta VCR	01
8 mm VCR	02
VHS VCR	03
Video disc player	04

Note
In some rare cases, you may not be able to operate your non-Sony video equipment with the supplied Remote Commander. This is because your equipment may use a code that is not provided with this Remote Commander. In this case, please use the equipment's own remote control unit.

Fig. 6: MDP manufacturer code numbers

MANUFACTURER	CODE
SONY	04
KENWOOD	68
MAGNAVOX	52
MARANZ	54
MITSUBISHI	51
PANASONIC	55
PHILIPS	52
PIONEER	51
RCA	51
SANYO	57
SHARP	56
YAMAHA	53

Selecting a VCR mode directly — DIRECT PLAY

Follow these instructions to switch from TV to VCR mode by simply pressing the ► (playback) button on the supplied Remote Commander.

Example: Connect your VCR to the VIDEO 1 IN jacks, and set the VTR1-2-3 MDP selector to VTR2. When you press ►, the input mode changes to the VCR connected to the VIDEO 1 IN jacks.

After completing the steps below, the VTR selector position is retained in the projection TV's memory.

Remote Commander (inner panel)

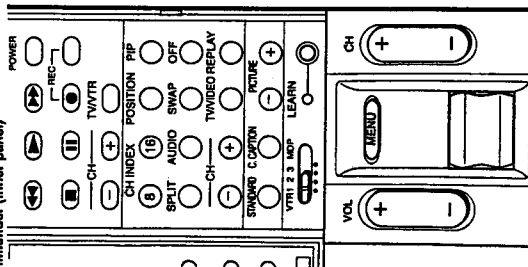

1 Press MENU.
The main menu appears.



2 Press the rocker control up or down until the cursor points to "SET UP."

3 Click the rocker control.
The set up menu appears.



4 Press the rocker control up or down until the cursor points to "DIRECT PLAY."

5 Click the rocker control.
A message screen appears.

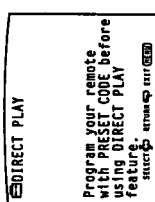

Note
This screen reminds you to set the manufacturer's code, if you have not already done so (pp. 76 - 78).

6 Click the rocker control again.
The DIRECT PLAY screen appears.

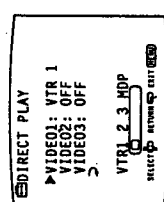

7 Press the rocker control up or down until the cursor points to the Video Input mode. (When the video equipment is connected to VIDEO 1 IN, select "VIDEO1.")

8 Click the rocker control.
The mode display turns red.

9 Press the rocker control up or down to select the VTR selector mode you have set on the Remote Commander. (When the VTR1-2-3 MDP selector is set to VTR2, select "VTR 2.")
Each time you press the rocker control up or down, "VTR 1," "VTR 2," "VTR 3," "MDP" and "OFF" appear in sequence.

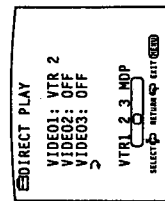

10 Click the rocker control.
The direct play setting is complete.

To set direct play for other connected video equipment
Repeat steps 7 - 10.

To return to the previous menu
Press the rocker control up or down until the cursor points to "► MENU."

To return to the main menu
Repeat the above, until you reach the main menu.
To return to the normal screen.
Press MENU on the Remote Commander.

1-18. TROUBLESHOOTING

Disturbances in picture and sound can often be eliminated by checking the symptoms and following the suggestions listed here. If the problem still cannot be solved, contact your nearest service facility.

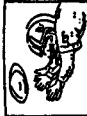
Symptom	Possible causes and remedies
No picture (screen not lit), no sound	<ul style="list-style-type: none"> • Make sure POWER is switched on. • Check the power cord connection. • Check that the TV/VIDEO and VTR1-2-3 MDP controls are set correctly. • Make sure that the TV/CABLE BOX selector is set to TV.
Poor or no picture (screen not lit), good sound	<ul style="list-style-type: none"> • Adjust the picture using the VIDEO screen (pp. 50 - 53). • Check the antenna/cable connections. • Adjust the color registration (pp. 26 - 27).
Good picture, no sound	<ul style="list-style-type: none"> • Press VOLUME + on the projection TV or VOL. + on the Remote Commander. • Press MUTING on the Remote Commander. • Check the MTS setting (p. 58). • Check that the TV/VIDEO and VTR1-2-3 MDP controls are set correctly. • Make sure SPEAKER is set correctly (p. 59).
No color for color programs	<ul style="list-style-type: none"> • Check the HUE and COLOR settings (pp. 50 - 51).
Snow and noise only	<ul style="list-style-type: none"> • Check that it is an active or correct channel. • Check the cable setting. • Check the ANT/AUX button setting. • Check antenna/cable connections.
 Dotted lines or stripes	<p>This is often caused by local interference (for example, cars, neon signs and hairdryers). Adjust the telescopic aerial for minimum interference.</p>
 Double images or ghosts	<p>Reflections from nearby mountains or buildings often cause this problem. Connecting a highly directional outdoor antenna or a CATV cable may improve the picture.</p>
Remote control does not operate	<ul style="list-style-type: none"> • Check the battery in the Remote Commander.
No picture and/or sound for the connected equipment	<ul style="list-style-type: none"> • Check that the TV/VIDEO button is set correctly. • Check that the connections are properly made. • Check that the power of the connected equipment is turned on. • Check that the connected equipment is set correctly.
Try another channel. It could be station trouble.	

SECTION 2 DISASSEMBLY

2-1. H2 BOARD REMOVAL (KP-46XBR35/53XBR35 (US/CND) only)

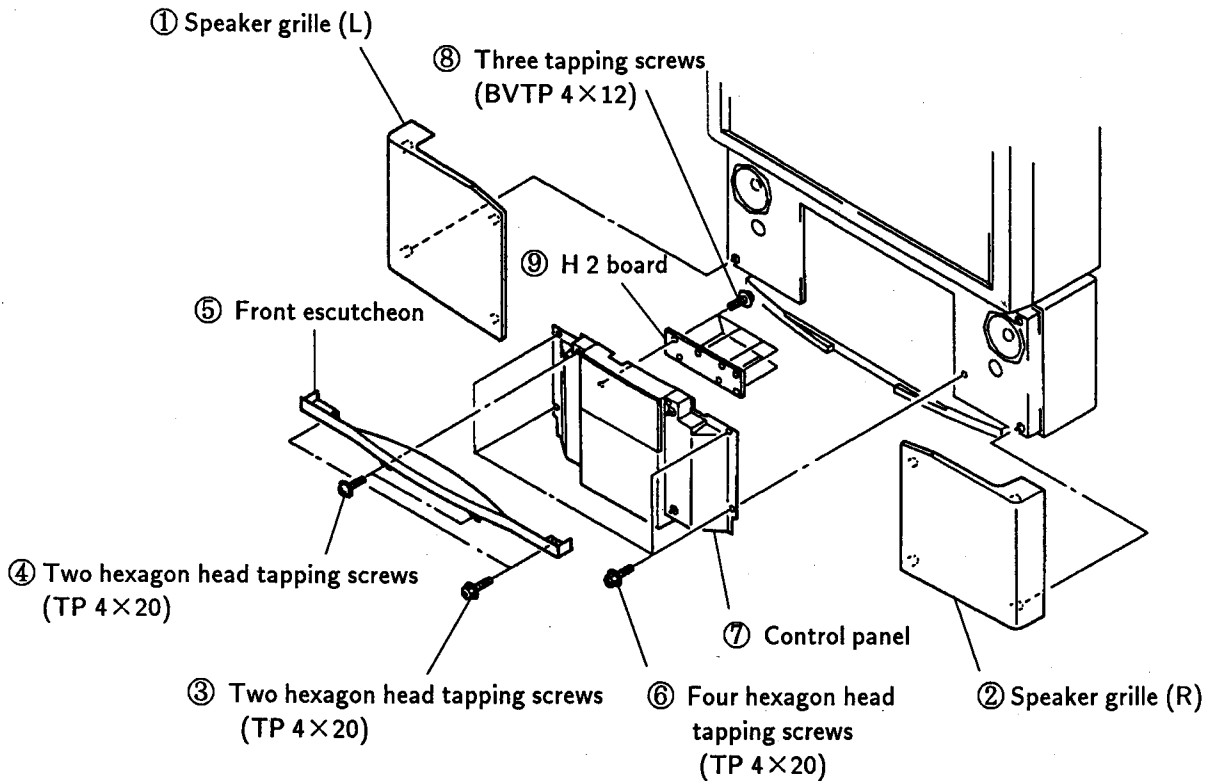

2-2. H1 BOARD REMOVAL (KP-46XBR35/53XBR35 (US/CND) only)

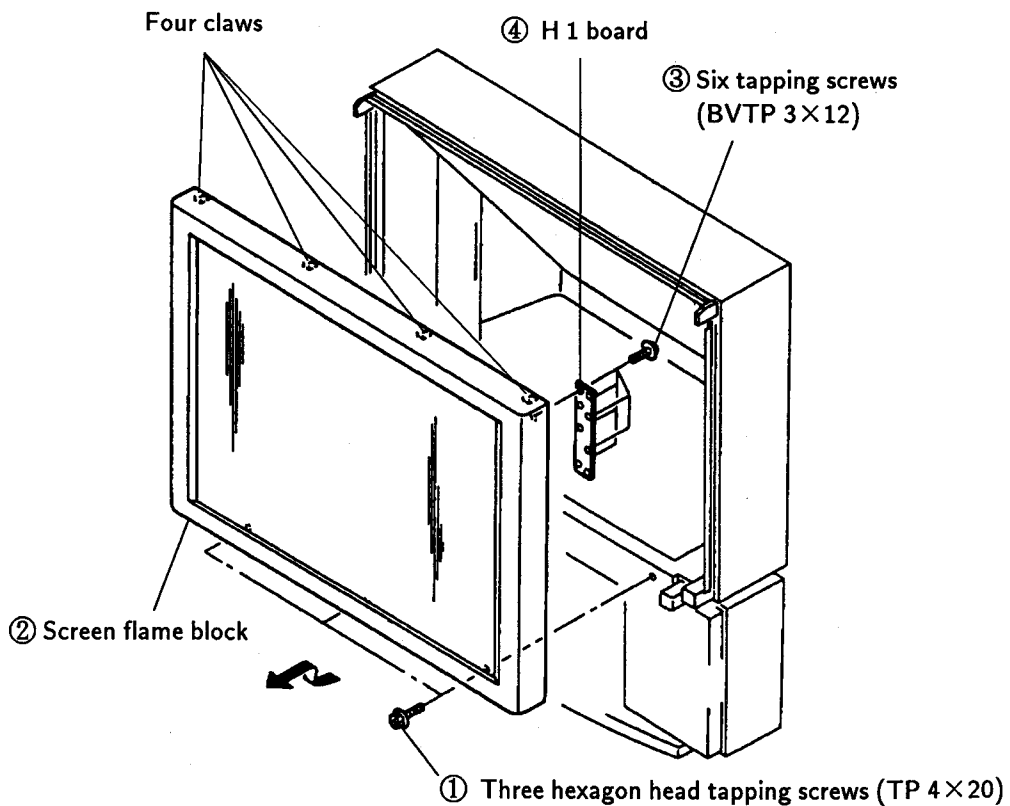

2-3-1. H1 AND H2BOARDS REMOVAL (KP-61XBR38 only)

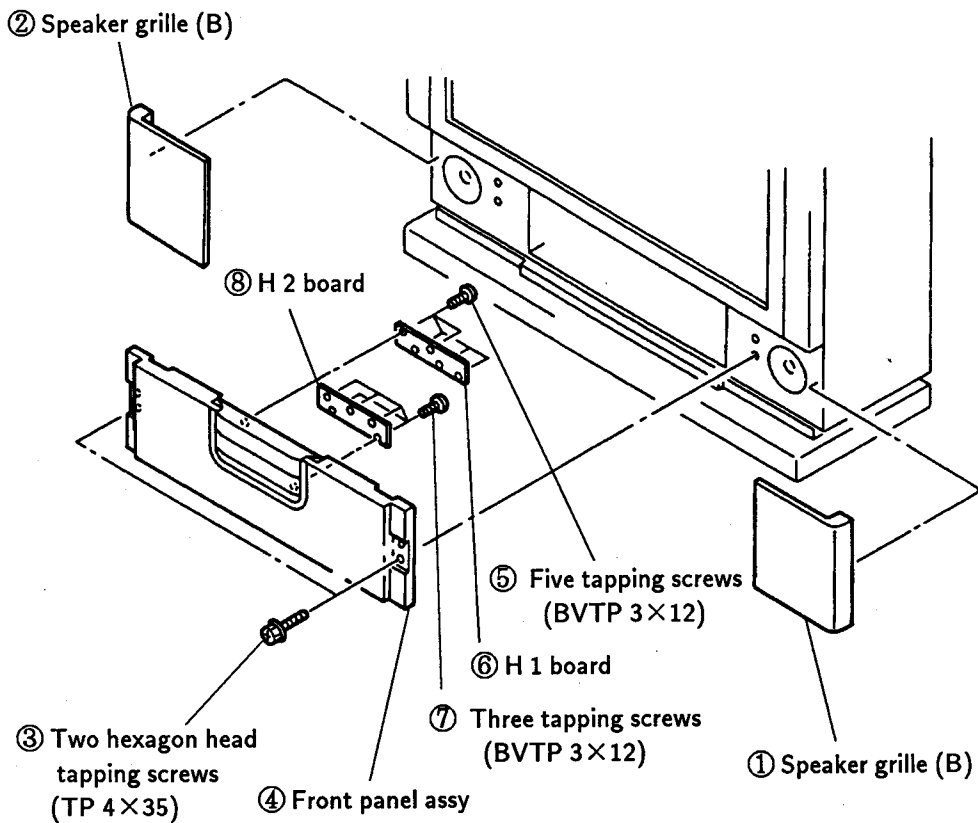

2-3-2. SCREEN FRAME REMOVAL (KP-61XBR38 only)

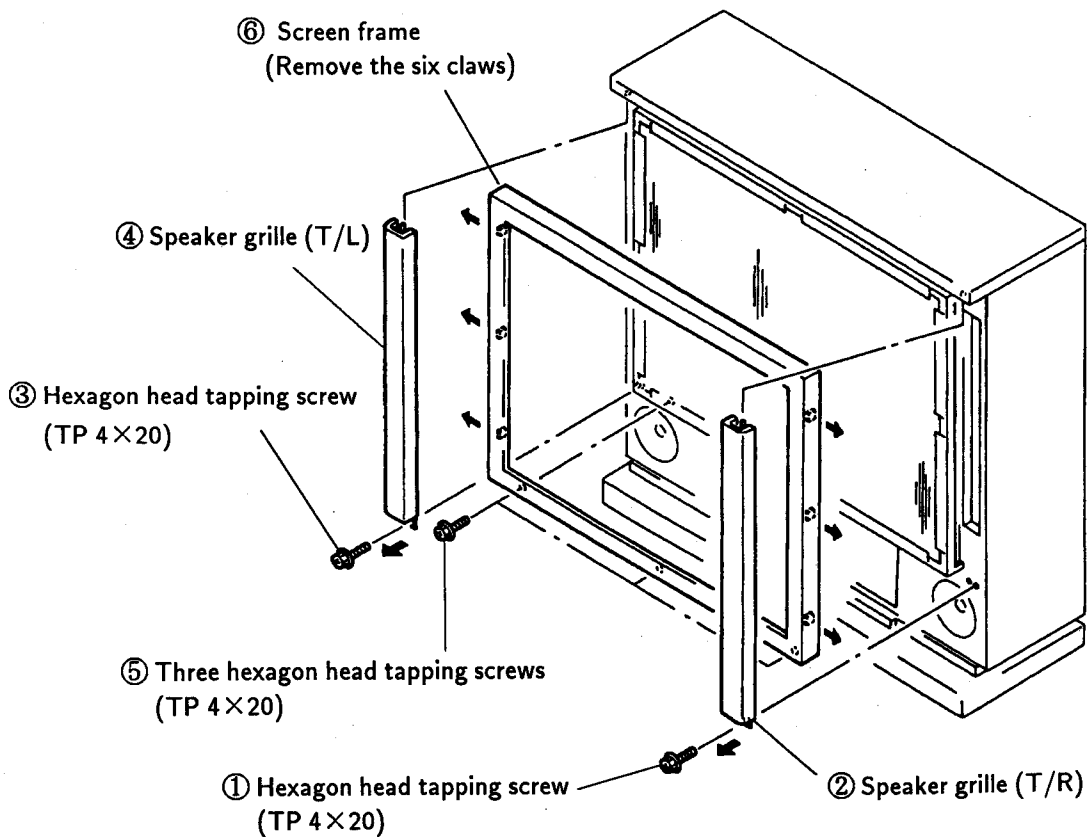

2-4. D BOARD REMOVAL

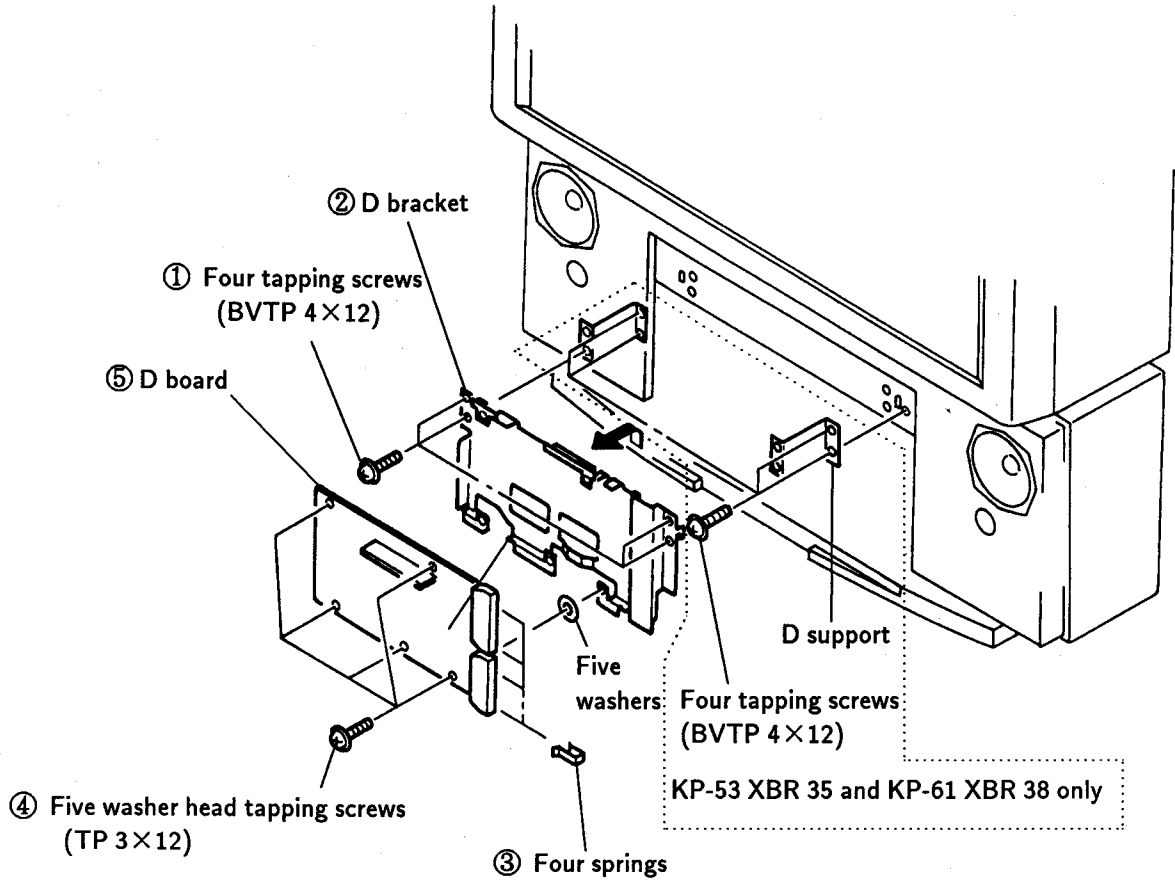

2-5. BACK COVER REMOVAL

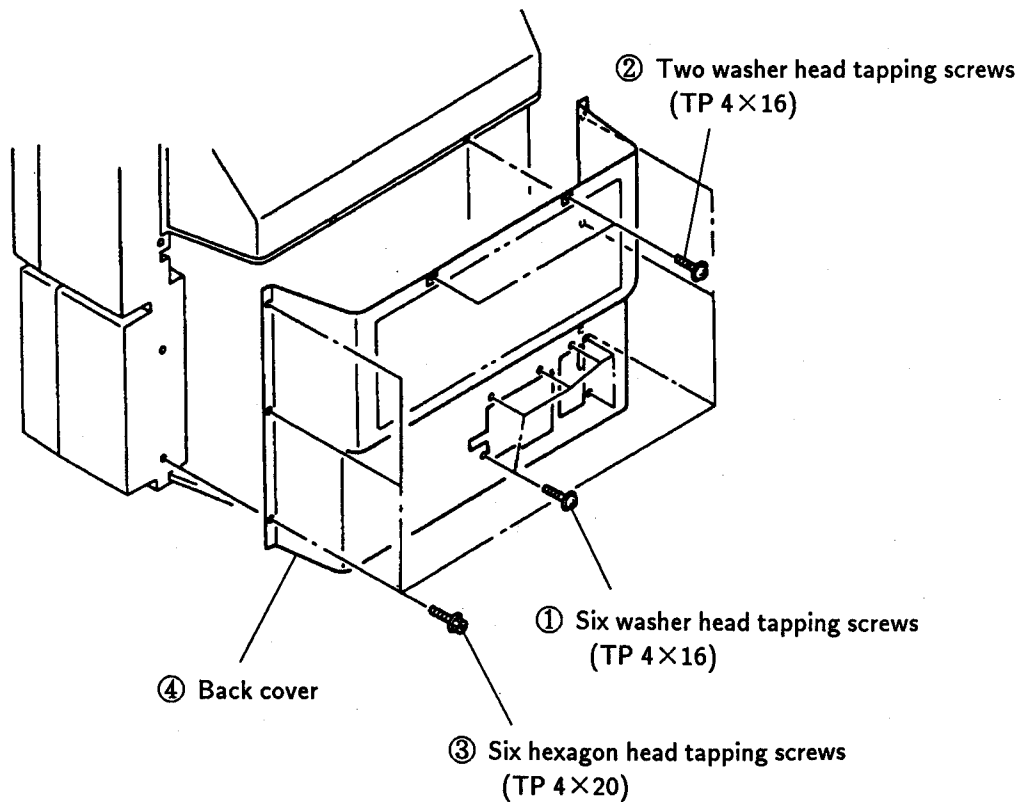

2-6. YA BOARD REMOVAL

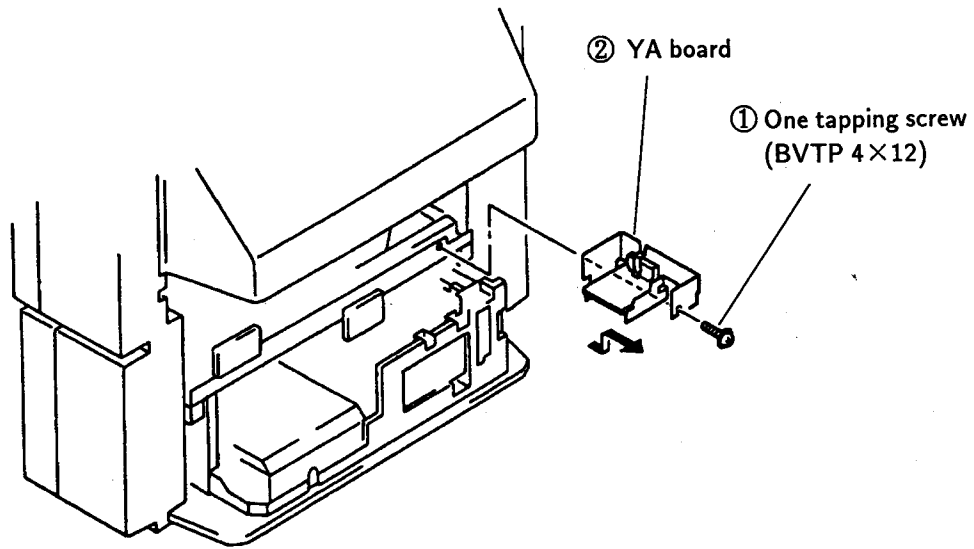

2-7. MAIN CHASSIS ASSY REMOVAL

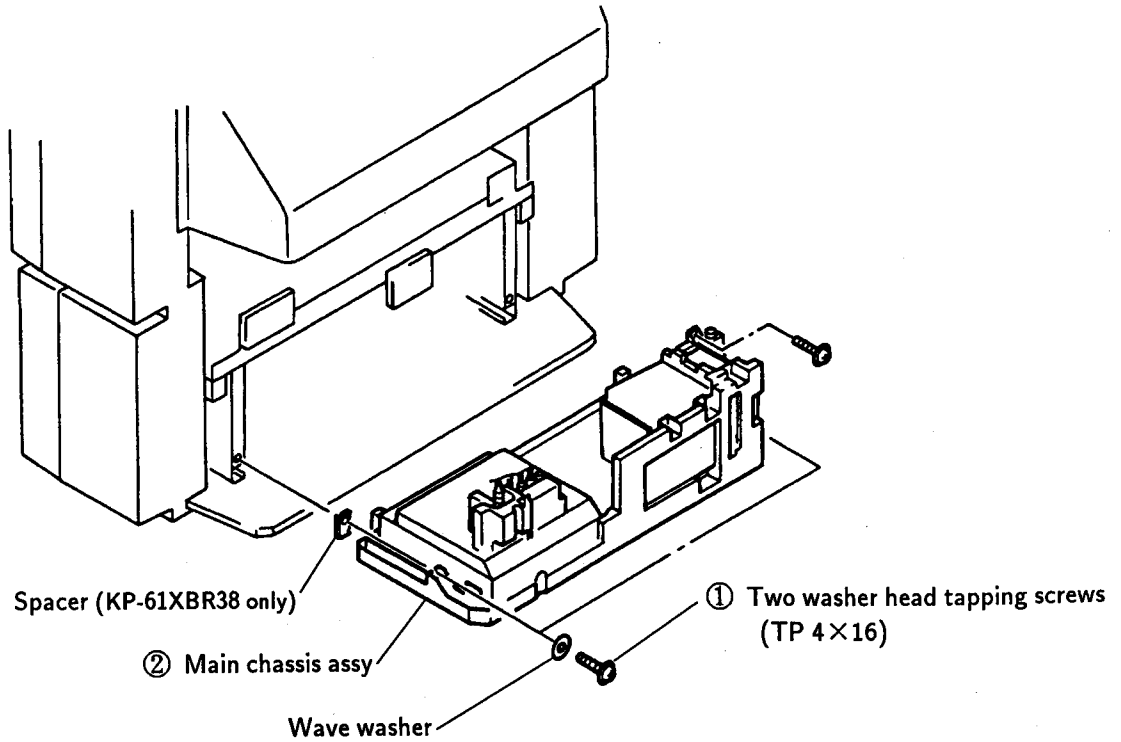

2-8. SERVICE POSITION

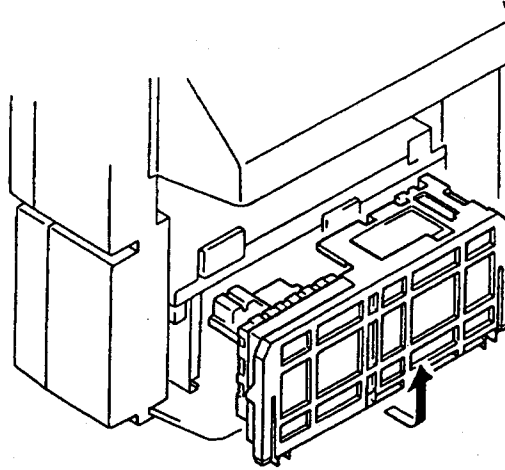

NOTES INSERTED IN SERVICE POSITION SECTION

Service Position Procedure

- (1) Remove the path locks where the harness comes into.
(MAIN bracket, G shield)
- (2) Remove the following connectors before removing the main bracket.
* HV grounding lead, G shield grounding lead, uT35 grounding lead (uT board), V-2 connector (V board).
- (3) Remove the main bracket. (Take care as the connector leads linking to the C and Z boards are considerably short.)
(MAIN bracket, G shield)
- (4) When pulling out the main bracket with power ON, be sure to connect the connectors removed.
* HV grounding lead, G shield grounding lead, uT35 grounding lead (uT board).

In case that grounding lead (Black) of HV Block is not connected with chassis grounding, it causes arcing of CRT and it is dangerous.

Be sure to connect grounding lead of HV Block with chassis grounding.

CONNECTOR CABLES

✳ In order to put the set in the service position, use the extension connector cables below.

<table border="1"> <thead> <tr> <th>Parts No.</th> <th>Connection</th> </tr> </thead> <tbody> <tr> <td>1-941-897-38</td> <td>CB-4 (G-4)</td> </tr> </tbody> </table> <p>1: Brown 2: — 3: — 4: Yellow 5: Green 6: — 7: — 8: Gray</p> <p>White L=140 White</p>	Parts No.	Connection	1-941-897-38	CB-4 (G-4)	<table border="1"> <thead> <tr> <th>Parts No.</th> <th>Connection</th> </tr> </thead> <tbody> <tr> <td>1-941-897-43</td> <td>CR-15 (A-15)</td> </tr> </tbody> </table> <p>1: White/Gray 2: Gray/Shield 3: Orange 4: Red/Gray 5: Gray/Shield</p> <p>Red L=180 Red</p>	Parts No.	Connection	1-941-897-43	CR-15 (A-15)
Parts No.	Connection								
1-941-897-38	CB-4 (G-4)								
Parts No.	Connection								
1-941-897-43	CR-15 (A-15)								
<table border="1"> <thead> <tr> <th>Parts No.</th> <th>Connection</th> </tr> </thead> <tbody> <tr> <td>1-941-897-39</td> <td>CG-16 (A-16)</td> </tr> </tbody> </table> <p>1: White/Gray 2: Gray/Shield 3: Orange 4: Red/Gray 5: Gray/Shield</p> <p>Yellow L=110 Yellow</p>	Parts No.	Connection	1-941-897-39	CG-16 (A-16)	<table border="1"> <thead> <tr> <th>Parts No.</th> <th>Connection</th> </tr> </thead> <tbody> <tr> <td>1-941-897-44</td> <td>ZR-1 (D-1)</td> </tr> </tbody> </table> <p>1: Brown 2: Red 3: Orange 4: Yellow 5: Green 6: Blue 7: Violet</p> <p>White L=150 White</p>	Parts No.	Connection	1-941-897-44	ZR-1 (D-1)
Parts No.	Connection								
1-941-897-39	CG-16 (A-16)								
Parts No.	Connection								
1-941-897-44	ZR-1 (D-1)								
<table border="1"> <thead> <tr> <th>Parts No.</th> <th>Connection</th> </tr> </thead> <tbody> <tr> <td>1-941-897-40</td> <td>ZG-19 (A-19)</td> </tr> </tbody> </table> <p>1: Green 2: — 3: Black 4: — 5: Brown</p> <p>White L=150 White</p>	Parts No.	Connection	1-941-897-40	ZG-19 (A-19)	<table border="1"> <thead> <tr> <th>Parts No.</th> <th>Connection</th> </tr> </thead> <tbody> <tr> <td>1-941-897-45</td> <td>A-21 (CRT BRACKET)</td> </tr> </tbody> </table> <p>1: Black 2: Black</p> <p>White L=40 White</p>	Parts No.	Connection	1-941-897-45	A-21 (CRT BRACKET)
Parts No.	Connection								
1-941-897-40	ZG-19 (A-19)								
Parts No.	Connection								
1-941-897-45	A-21 (CRT BRACKET)								
<table border="1"> <thead> <tr> <th>Parts No.</th> <th>Connection</th> </tr> </thead> <tbody> <tr> <td>1-941-897-41</td> <td>ZR-18 (A-18)</td> </tr> </tbody> </table> <p>1: Red 2: — 3: Black 4: — 5: Brown</p> <p>White L=150 White</p>	Parts No.	Connection	1-941-897-41	ZR-18 (A-18)	<table border="1"> <thead> <tr> <th>Parts No.</th> <th>Connection</th> </tr> </thead> <tbody> <tr> <td>1-941-897-46</td> <td>V-2 (ZR-3)</td> </tr> </tbody> </table> <p>1: Brown 2: — 3: Red</p> <p>Red L=200 Red</p>	Parts No.	Connection	1-941-897-46	V-2 (ZR-3)
Parts No.	Connection								
1-941-897-41	ZR-18 (A-18)								
Parts No.	Connection								
1-941-897-46	V-2 (ZR-3)								
<table border="1"> <thead> <tr> <th>Parts No.</th> <th>Connection</th> </tr> </thead> <tbody> <tr> <td>1-941-897-42</td> <td>ZG-2 (D-2)</td> </tr> </tbody> </table> <p>1: — 2: Red 3: Orange 4: Yellow 5: Green 6: Blue 7: Violet 8: Gray</p> <p>White L=130 White</p>	Parts No.	Connection	1-941-897-42	ZG-2 (D-2)	<table border="1"> <thead> <tr> <th>Parts No.</th> <th>Connection</th> </tr> </thead> <tbody> <tr> <td>1-941-897-47</td> <td>A-3 (YG-3)</td> </tr> </tbody> </table> <p>1: Red 2: White 3: Gray/Shield 4: Black</p> <p>Red L=100 Red</p>	Parts No.	Connection	1-941-897-47	A-3 (YG-3)
Parts No.	Connection								
1-941-897-42	ZG-2 (D-2)								
Parts No.	Connection								
1-941-897-47	A-3 (YG-3)								

2-9. P 3 BOARD REMOVAL

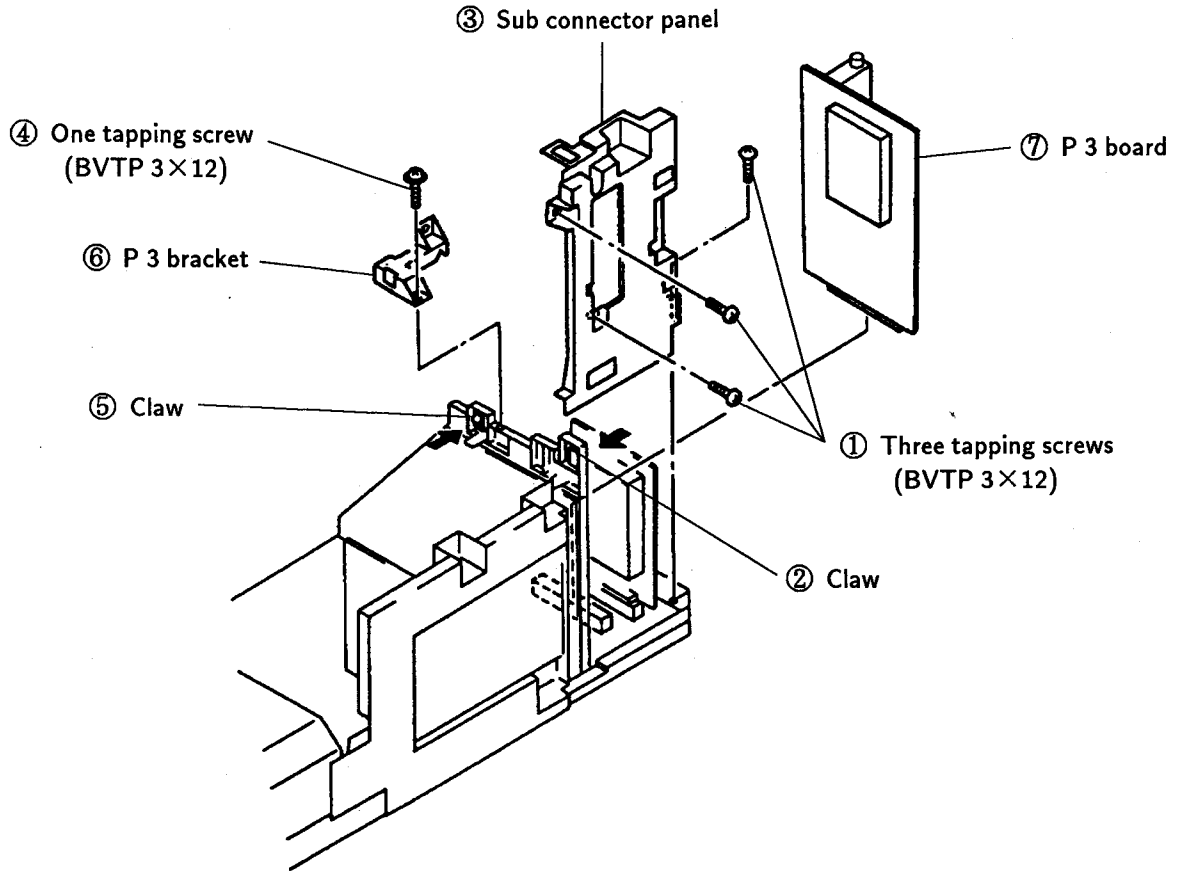

2-10. MAIN CONNECTOR PANEL REMOVAL

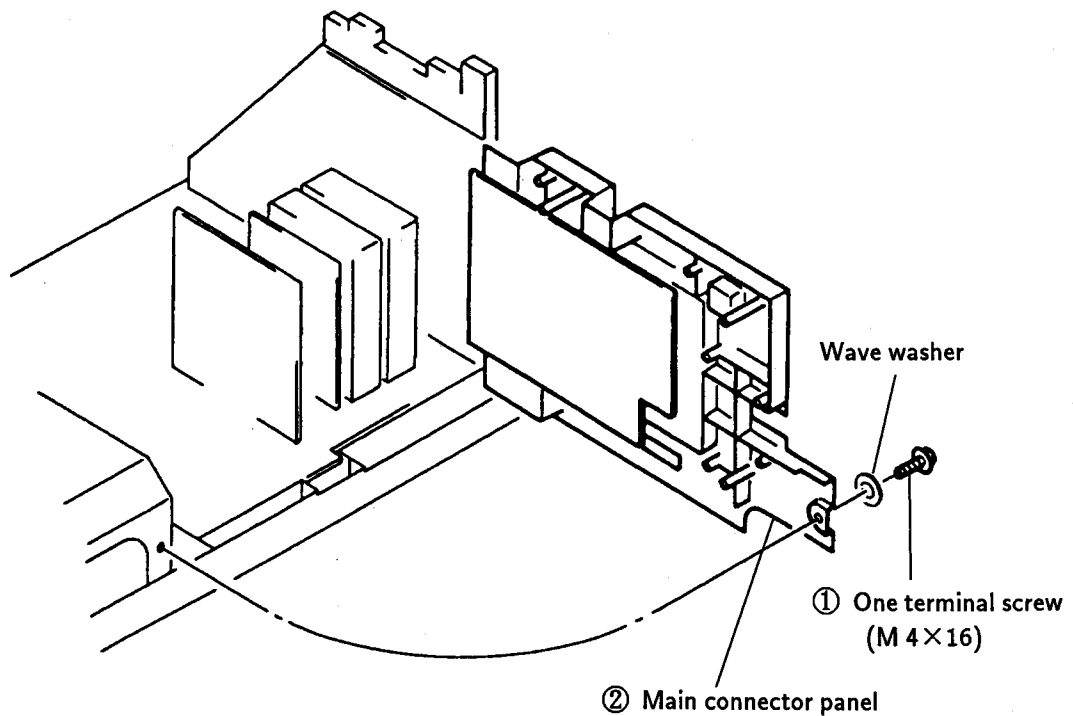

2-11. U AND P 4 BOARDS REMOVAL

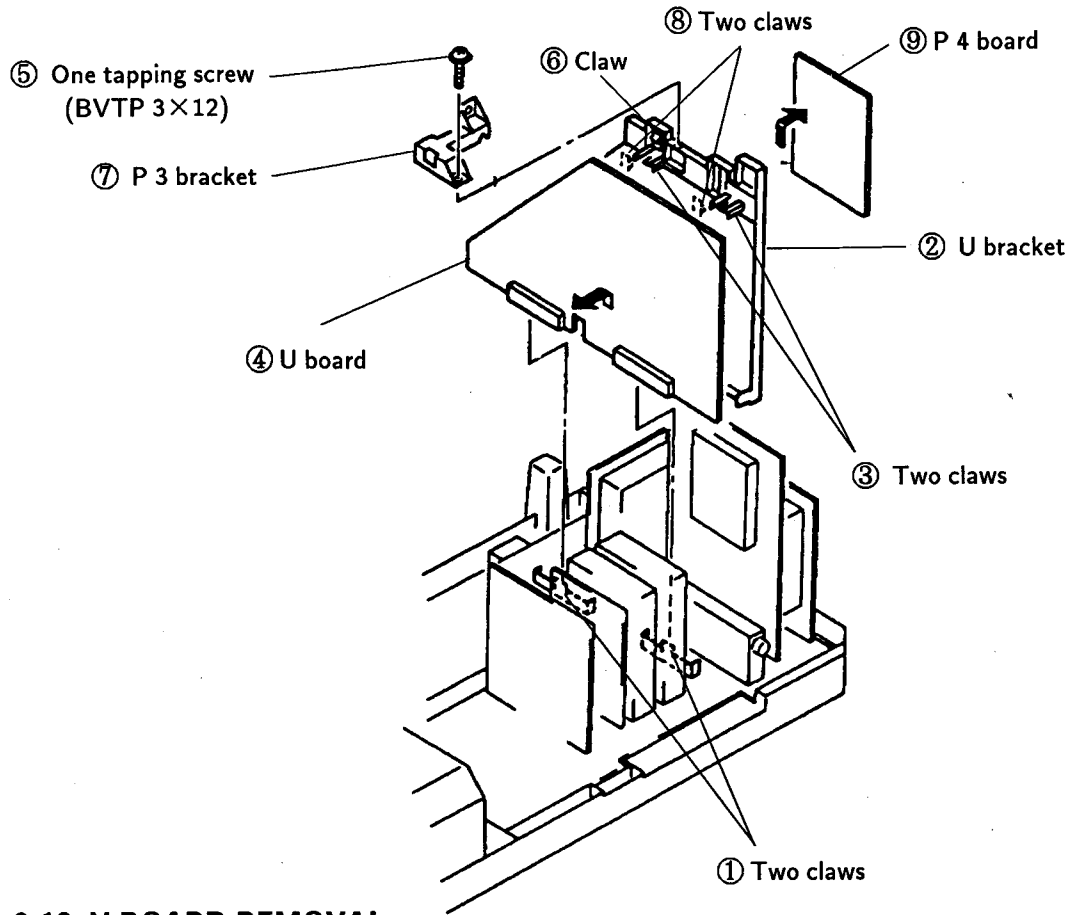

2-12. V BOARD REMOVAL

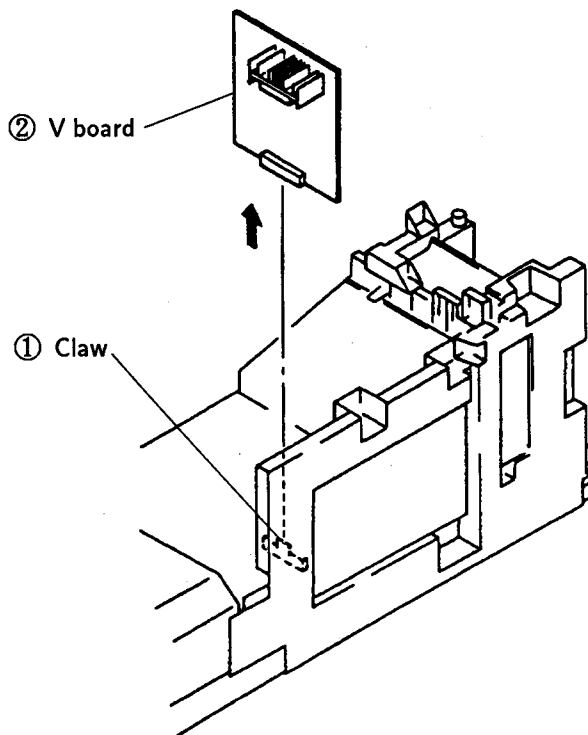

2-13. N BRACKET REMOVAL

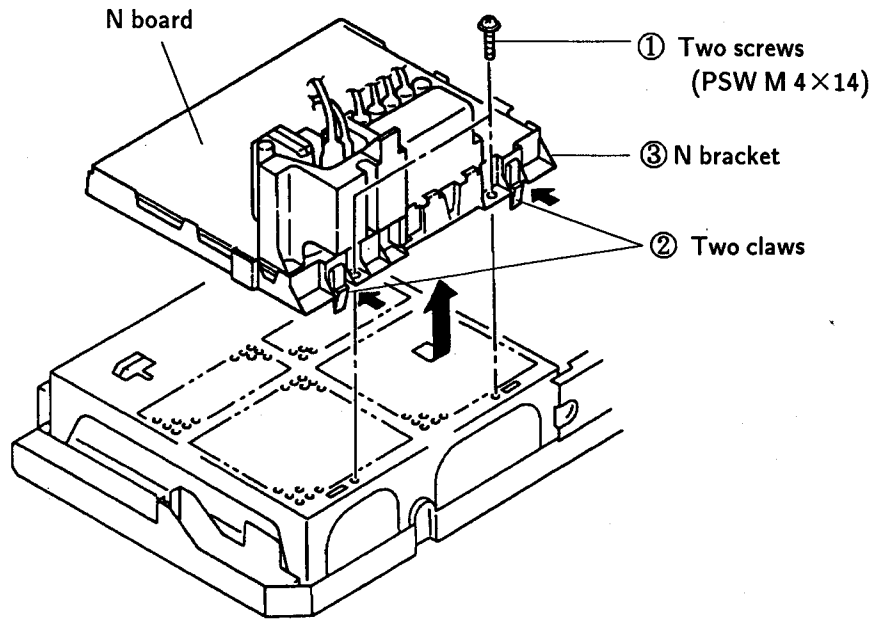

2-14. G BOARD REMOVAL

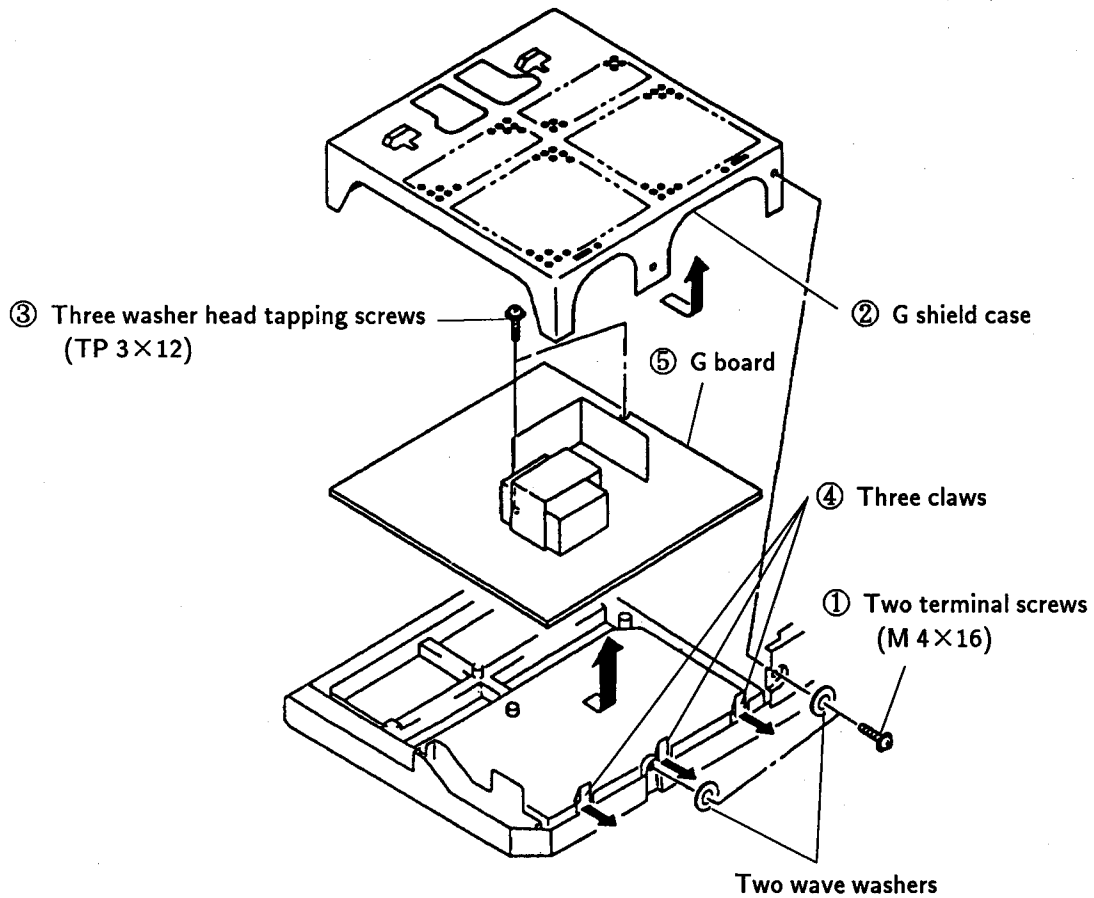

2-15-1. CONNECTOR CABLE

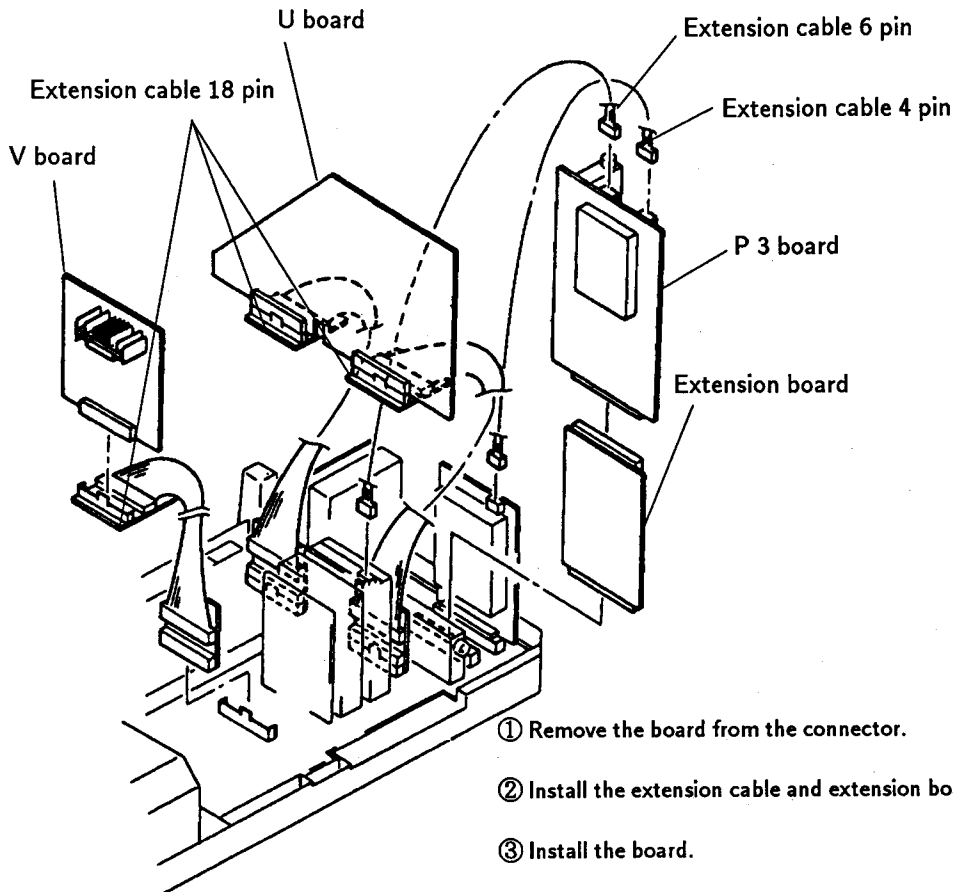

Exterior	
Extension cable	
4 pin	1-941-891-33
6 pin	1-941-891-31
7 pin	1-941-891-32
18 pin	3-702-558-01
10 pin	3-702-557-01
36 pin connector	3-702-561-01
50 pin connector	3-702-560-01
36/50 pin	3-702-559-01
Extension board	36/50 pin

2-15-2. CONNECTOR CABLE

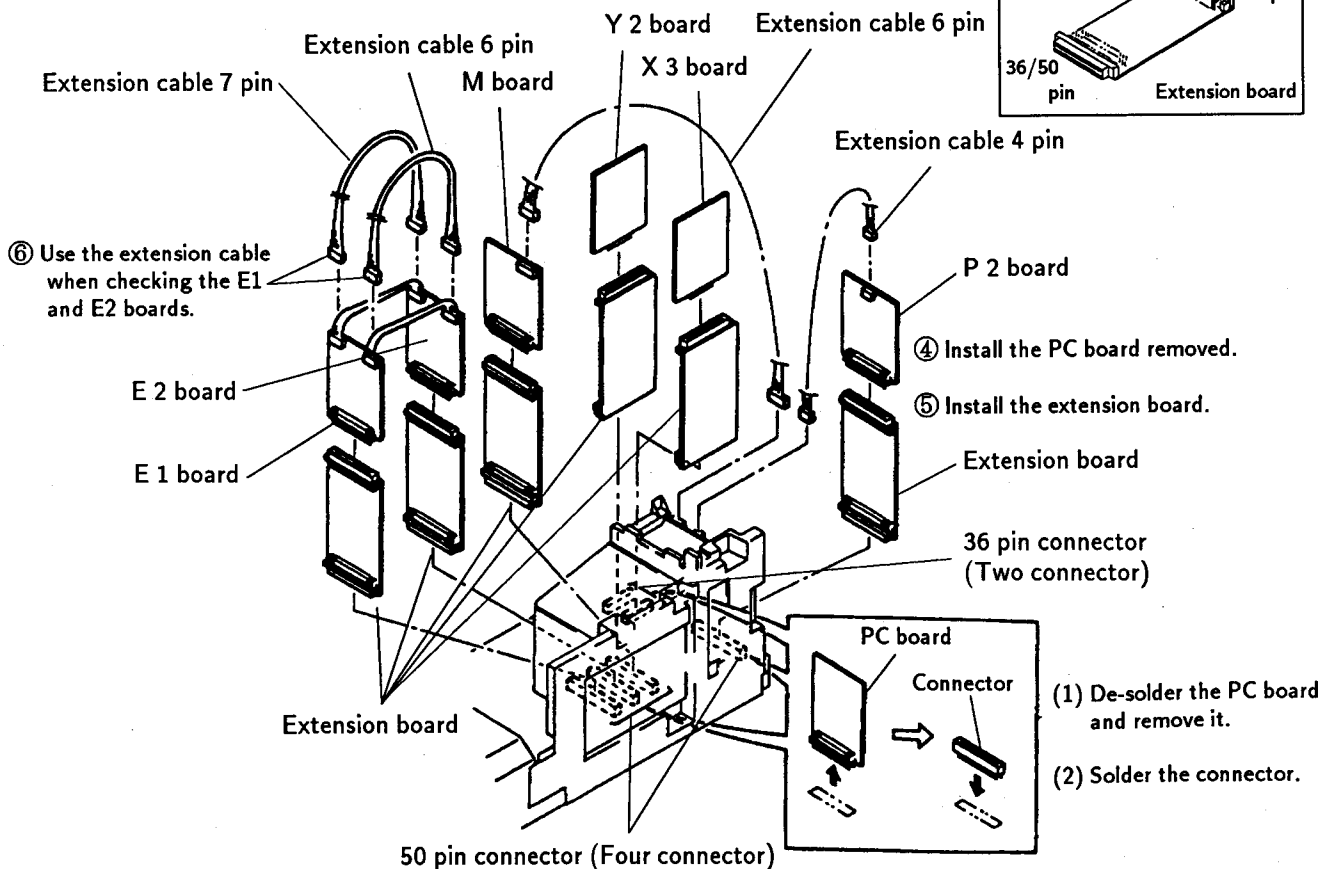

2-16. CHASSIS ASSY REMOVAL

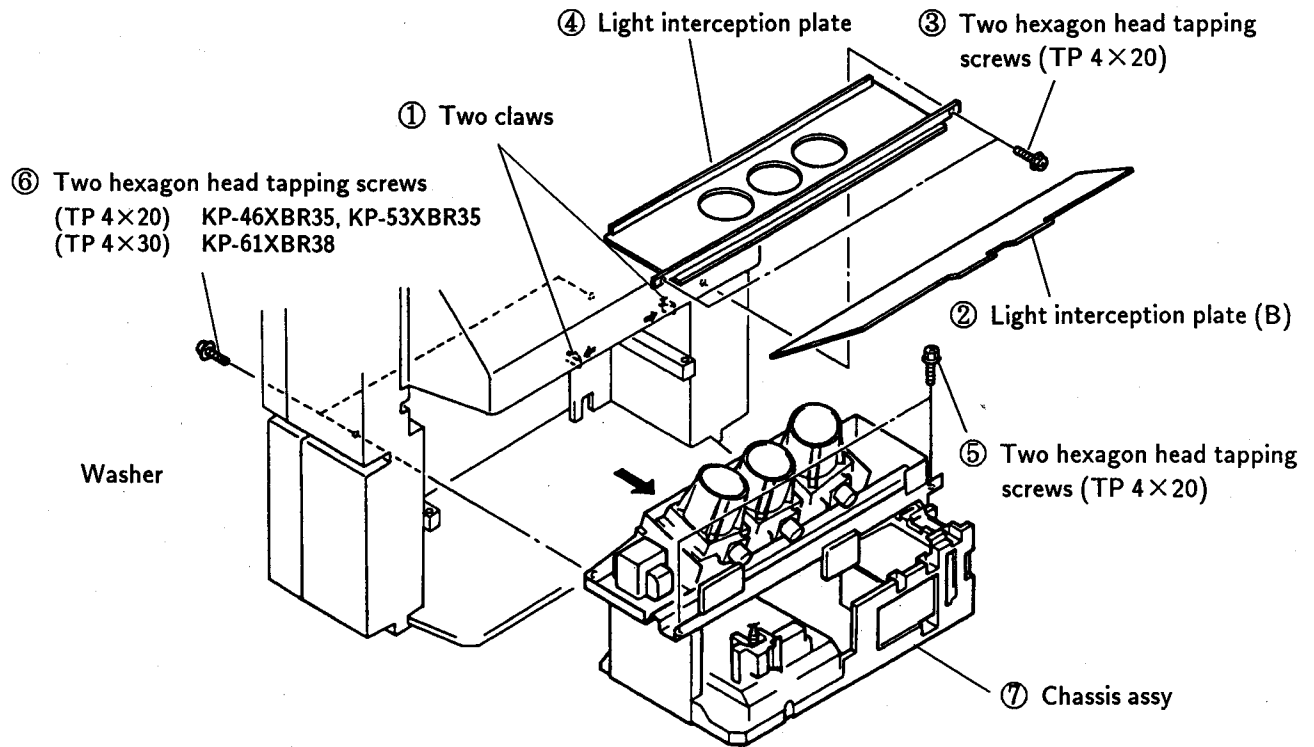

2-17. PICTURE TUBE REMOVAL

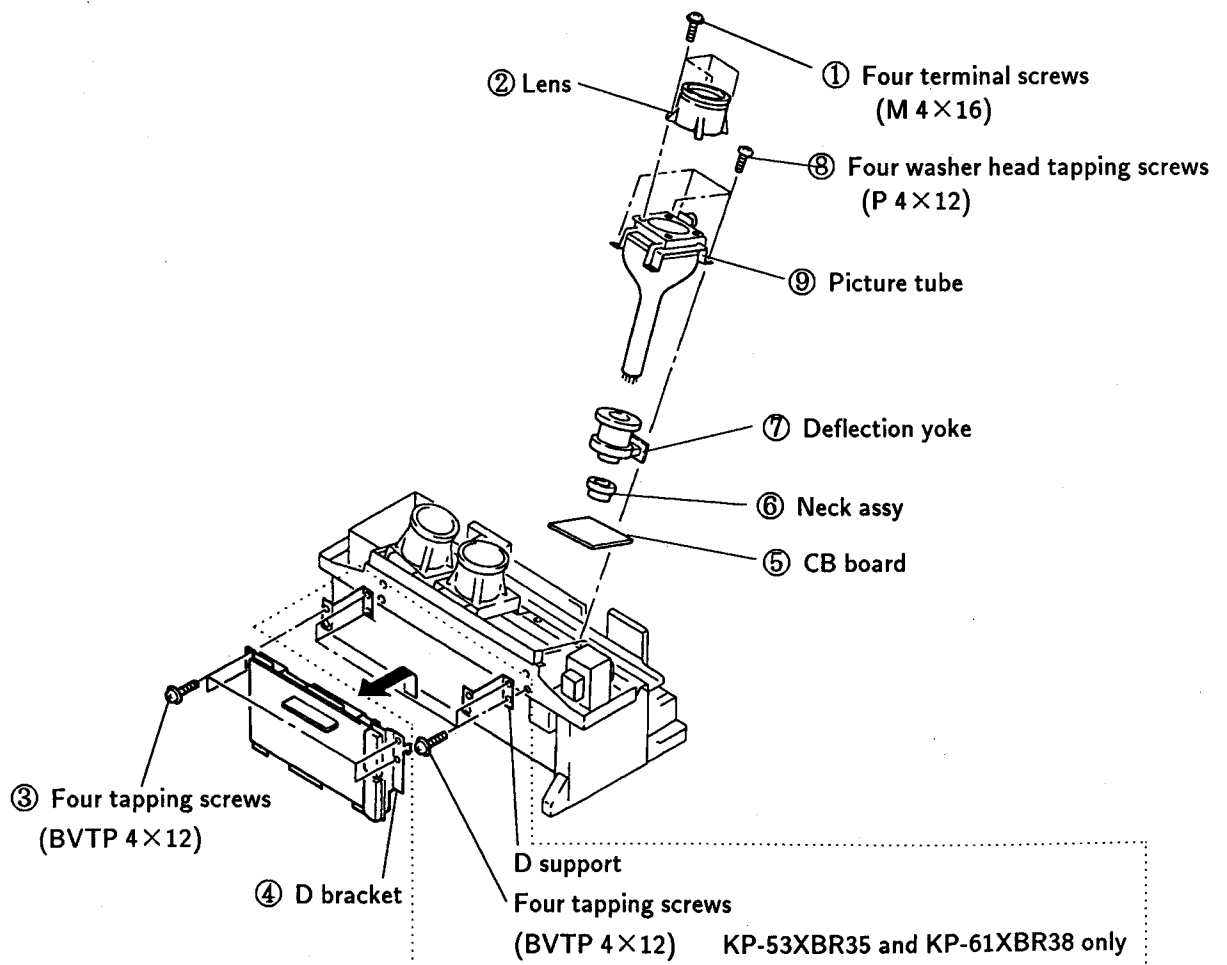

2-18. HIGH-VOLTAGE CABLE INSTALLATION AND REMOVAL

(1) Remover

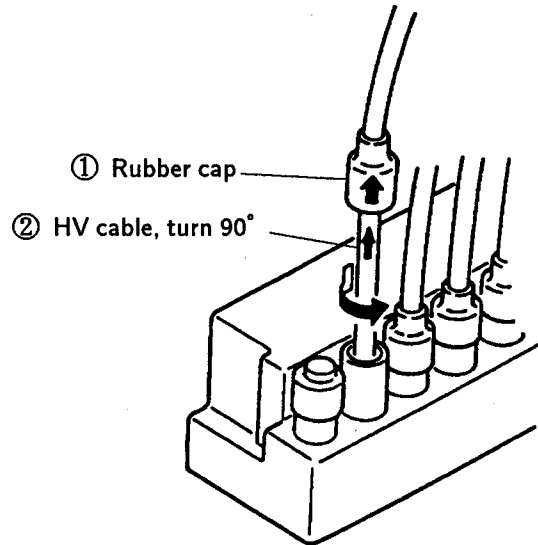

(2) Installation

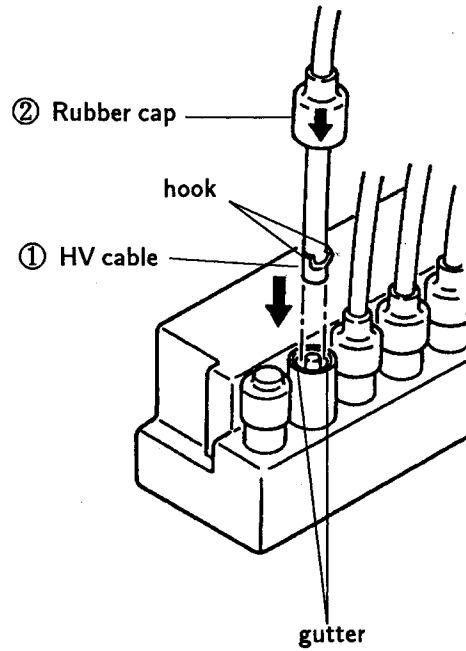

SECTION 3

SETUP ADJUSTMENTS

3-1. FOCUS LENS ADJUSTMENTS

1. Set the D-board registration variable resistors (VR) to mechanical center.
2. Set the centering magnets (for red, green, and blue) to 0 as shown in the figure.

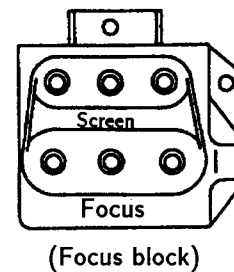
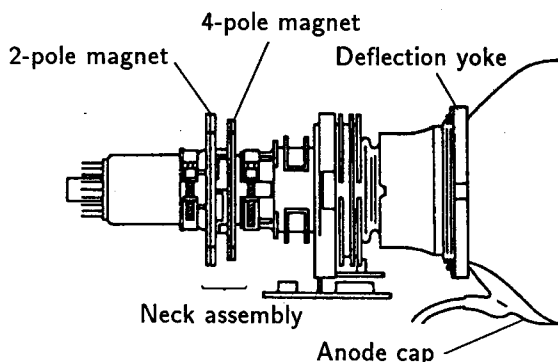

Verify that scanning lines are seen.

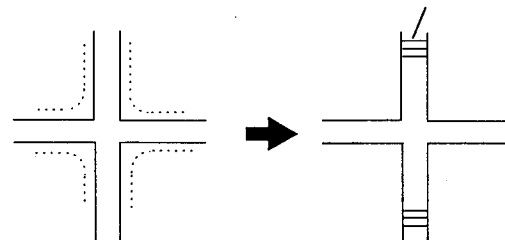

3. Input monoscope signal. Set 50% BRIGHTNESS and minimum PICTURE. Make rough adjustment so that 10IRE of the monoscope signal becomes faintly luminous using the screen VRs.
4. Set PICTURE and BRIGHTNESS maximum. Press the commander menu button. Select CONVERGENCE to display test signal.
5. Enter service mode. Select R OFF of SERVICE MODE to cut off red output. Similarly, select B OFF to cut off blue output.
6. Turn the green lens to eliminate flare of the test signal.

7. Turn the green focus VR in the focus block to adjust green focus to reduce both A and B of the test signal to minimum.

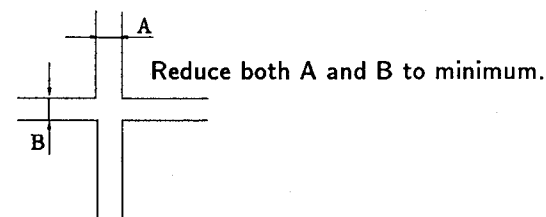

8. Repeat above 6 and 7. Couple of times to improve tracking and obtain an optimum focus. Then tighten the green lens screw.
9. Adjust the red and blue focuses similarly.

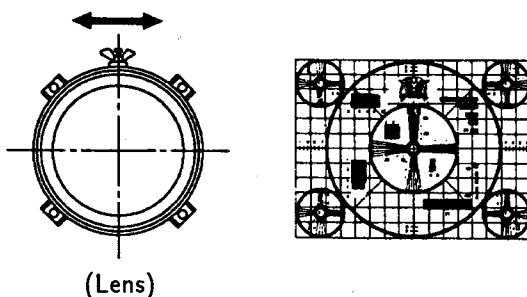

3-2. DEFLECTION YOKE POSITION ADJUSTMENTS

1. Input monoscope signal.
2. Enter service mode. Select R OFF of SERVICE MODE to cut off red output. Similarly, select B OFF to cut off blue output.
3. Loosen the deflection yoke (DY) fitting screws. Tilt the DY to obtain the best horizontal and vertical monoscope patterns.
4. After adjustment, press the DY onto the cathode ray tube (CRT) funnel and tighten the screws.
5. Also adjust DY positions for red and blue outputs in the same way.

3-3. 2-POLE MAGNET ADJUSTMENT

1. Input dot signal.
2. Enter service mode. Select R OFF of SERVICE MODE to cut off red output.
Similarly, select B OFF to cut off blue output.
3. Set PICTURE to maximum. Turn the green focus variable resistor (VR) in the focus block counterclockwise from the just focus to brighten the point in the dot.
4. Adjust the 2-pole magnet to position the bright point at the center of the dot.
5. Adjust the red and blue dots in the same way.

* Use the center dot:red and green
Use the vertical center and left end dot :blue

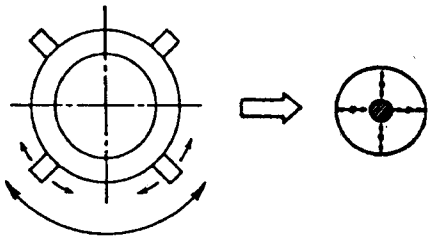

3-4. 4-POLE MAGNET ADJUSTMENT

1. Input dot signal.
2. Enter service mode. Select R OFF of SERVICE MODE to cut off red output.
Similarly, select B OFF to cut off blue output.
3. Set PICTURE to maximum. Turn the green focus variable resistor (VR) in the focus block clockwise (count clockwise:blue)from the just focus until the dot diameter becomes as shown below.
4. Adjust the 2-pole magnet to make the dot perfectly round.
5. Turn the green focus variable resistor to the just focus.
6. Adjust the red and blue dot in the same way.

* Use the center dot : red and green
Use the vertical center and left end dot : blue

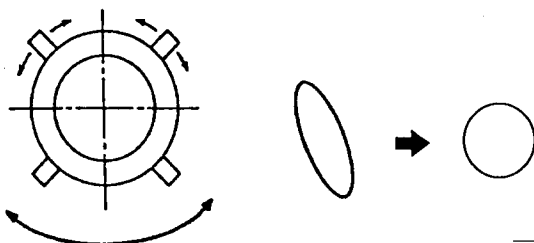

3-5. DE-FOCUS ADJUSTMENT (BLUE)

1. Input cross hatch signal.
2. Turn the blue focus variable resistor (VR) in the focus block counter clock wise so that thewidth of the left end vertical line becomes as shown below.

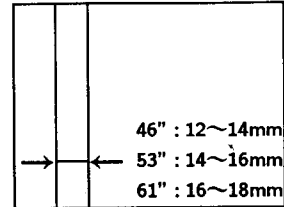

without flare

3-6. GREEN PICTURE ADJUSTMENTS

1. Input monoscope signal.
2. Enter service mode. Select R OFF of SERVICE MODE to cut off red output.
Similarly, select B OFF to cut off blue output.
3. Turn RV913 and RV960, the vertical green linearity variable resistors (V.G LIN VRs) on the D-board, to obtain an optimum vertical linearity.
Then turn RV911, the vertical green amplitude variable resistor (V.G SIZE VR) to set vertical amplitude to 11.7 flames.

Note: The vertical position indicator of the monoscope signal must be positioned at the center by adjusting RV905, the vertical green center position variable resistor (V.G CENT VR) in advance.

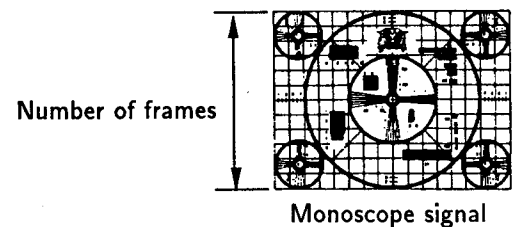

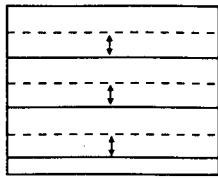

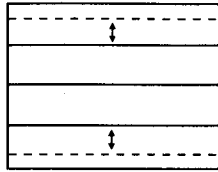

RV905 V.G CENT
(vertical position)



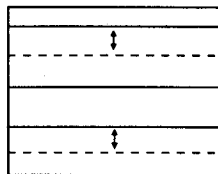

RV911 V.G SIZE
(vertical amplitude)

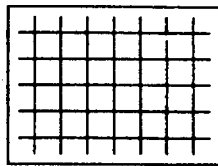

RV913 V.G LIN
(vertical linearity)

5. Verify that the horizontal lines on the top and bottom of cross-hatched area of the monoscope signal are horizontal and linear.



6. Turn RV916, RV964 and RV969, the horizontal green linearity variable resistors (H.G LIN VRs) on the D-board, to obtain an optimum horizontal linearity.

Then turn RV908, the horizontal green amplitude variable resistor (H.G SIZE VR) to set horizontal amplitude to 15.6 frames.

Note: The horizontal position indicator of the monoscope signal must be positioned at the center by adjusting RV902, the horizontal green center position variable resistor (V.G CENT VR) in advance.

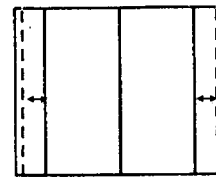
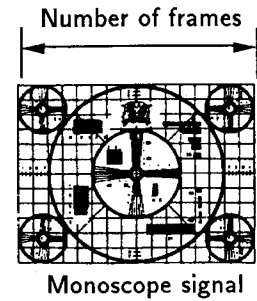

RV908 H.G SIZE
(horizontal position)

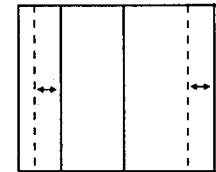

RV916 H.G LIN
(horizontal linearity)

7. Input cross hatch signal.

Turn vertical green (V.G) and horizontal green (H.G) variable resistors (VRs) and make adjustments according to the following steps :

(Adjustment procedure)

1. [BOW] → [SKEW] → [CENT (center position)]
2. [PIN (pin warp)] → [SUB BOW] → [BOW]
3. [KEYS (trapezoid)] → [SUB SKEW] → [SKEW]
4. [M.WAVE (middle sine wave warp)] → [WAVE-A (upper and lower sine wave warp)] → [WAVE-U (upper sine wave warp)]
※ For vertical (V) only.
5. [V-M.PIN (vertical middle pin warp)] → [V/WING (vertical wing warp)]
※ For vertical (V) only.
6. [H-M.PIN (horizontal middle pin warp)]
※ For horizontal (H) only.

(Dot motion)

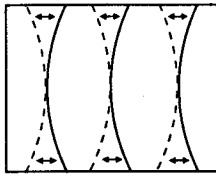

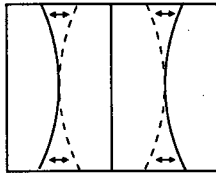

RV932 H.G BOW
(horizontal green bow)



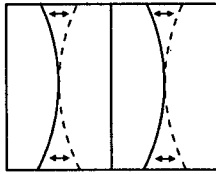

RV941 H.G PIN
(horizontal green pin warp)

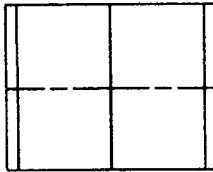



RV950 H.G SUB BOW
(horizontal green sub bow)

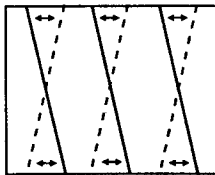

- V.G BOW.....RV935
- V.G PIN.....RV938
- V.G SUB BOW.....RV953



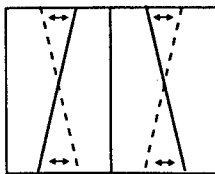

RV920 H.G SKEW
(horizontal green skew)



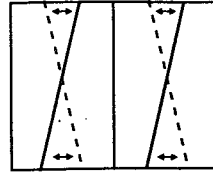

RV925 H.G KEYS
(horizontal green trapezoid)

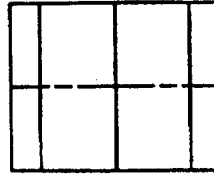



RV944 H.G SUB SKEW
(horizontal green sub skew)

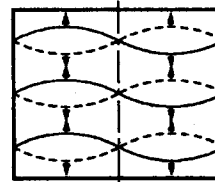

- V.G SKEW.....RV923
- V.G KEYS.....RV929
- V.G SUB SKEW.....RV947



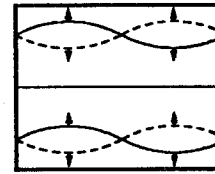

RV962 V-M-WAVE
(vertical middle sine wave warp)



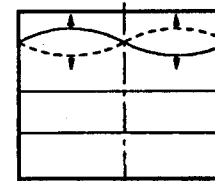

RV975 V-WAVE-A
(vertical upper and lower
sine wave warp)

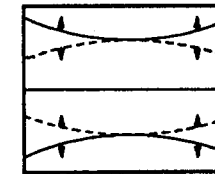



RV978 V-WAVE-U
(vertical upper sine wave warp)

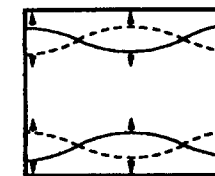

RV980 V-M. PIN
(vertical middle pin warp)
* Common in red, green,
and blue

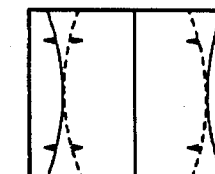

RV957 V/WING
(wing warp)
* Common in red, green,
and blue



RV956 H/M. PIN
(horizontal middle pin warp)

3-7. GREEN AND RED REGISTRATION ADJUSTMENTS

1. Input cross hatch signal.
2. Enter service mode. Select B OFF of SERVICE MODE to cut off blue output.
3. Turn the vertical red (V.R) and horizontal red (H.R) variable resistors (VRs) to adjust red picture convergence in relation to green picture according to the following steps :

(Adjustment procedure)

1. [LIN (linearity)] → [SIZE (amplitude)] → [CENT (center position)]
2. [BOW] → [SKEW] → [CENT (center position)]
3. [PIN (pin warp)] → [SUB BOW] → [BOW] [H/M. PIN (horizontal middle pin warp)]
4. [KEYS (trapezoid)] → [SUB SKEW] → [SKEW]
5. [M.WAVE (middle sine wave warp)] → [WAVE-A (upper and lower sine wave warp)] → [WAVE-U (upper sine wave warp)]

(Dot motion)

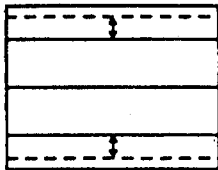

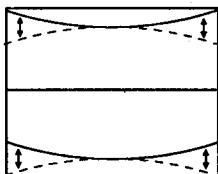

RV912 V.B SIZE
(vertical red amplitude)



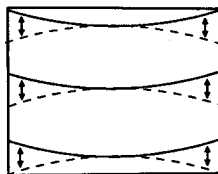

RV952 V.R SUB BOW
(vertical red sub bow)

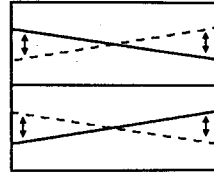



RV943 V.R BOW
(vertical red bow)

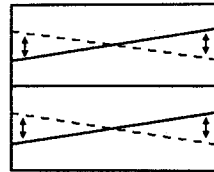



RV928 V.R KEYS
(vertical red trapezoid)

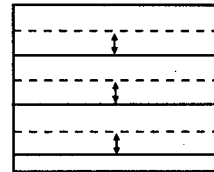



RV946 V.R SUB SKEW
(vertical red sub skew)

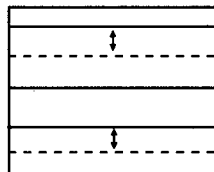

RV904 V.R CENT
(vertical red center position)

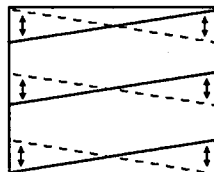

RV917 V.R LIN
(vertical red linearity)



RV922 V.R SKEW
(vertical red skew)

H.R LIN	RV915
H.R SIZE	RV907
H.R CENT	RV901
H.R BOW	RV931
H.R SKEW	RV919
H.R PIN	RV940
H.R KEYS	RV926
H.R SUB BOW	RV949
H.R SUB SKEW	RV943
V-M-WAVE	RV973
V-WAVE-A	RV976
V-WAVE-U	RV979
V-M.PIN	RV980
V/WING	RV957
H/M.PIN	RV956

3-8. GREEN AND BLUE REGISTRATION ADJUSTMENTS

1. Input cross hatch signal.
2. Enter service mode. Select R OFF of SERVICE MODE to cut off red output.
3. Turn the vertical blue (V.B) and horizontal blue (H.B) variable resistors (VRs) to adjust blue picture convergence in relation to green picture according to the following steps :

(Adjustment procedure)

1. [LIN (linearity)] → [SIZE (amplitude)] → [CENT (center position)] →
2. [BOW] → [SKEW] → [CENT (center position)]
3. [PIN (pin warp)] → [SUB BOW] → [BOW] [H/M. PIN (horizontal middle pin warp)]
4. [KEYS (trapezoid)] → [SUB SKEW] → [SKEW]
5. [M.WAVE (middle sine wave warp)] → [WAVE-A (upper and lower sine wave warp)] → [WAVE-U (upper sine wave warp)] →

(Dot motion)

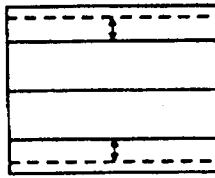

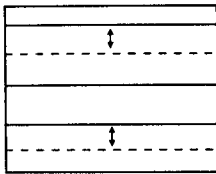

RV912 V.B SIZE
(vertical blue amplitude)



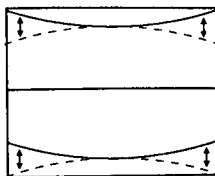

RV918 V.B LIN
(vertical blue linearity)

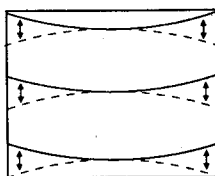



RV954 V.B SUB BOW
(horizontal blue sub bow)

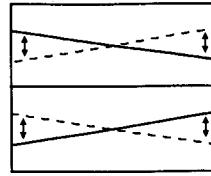



RV936 V.B BOW
(vertical blue bow)

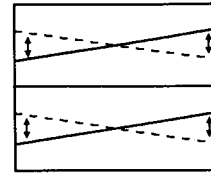



RV930 V.B KEYS
(vertical blue trapezoid)

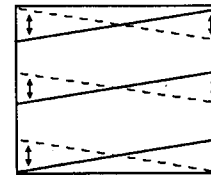



RV948 V.B SUB SKEW
(vertical blue sub skew)

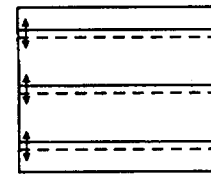



RV924 V.B SKEW
(vertical blue skew)

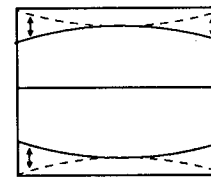



RV906 V.B CENT
(vertical blue center position)

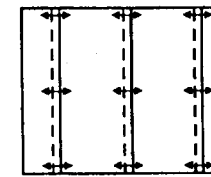



RV939 V.B PIN
(vertical blue pin warp)

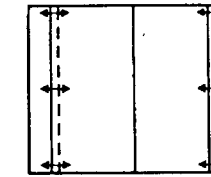



RV903 H.B CENT
(vertical blue center position)

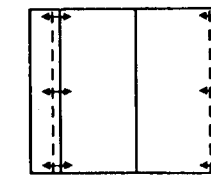



RV909 H.B SIZE
(horizontal blue amplitude)

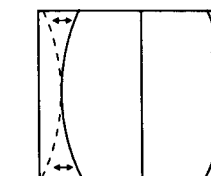



RV914 H.B LIN
(horizontal blue linearity)

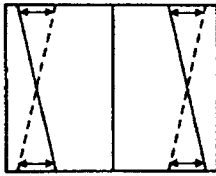



RV942 H.B PIN
(horizontal blue pin warp)

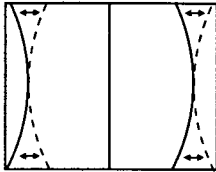

RV954 H.B SUB SKEW
(horizontal blue sub skew)

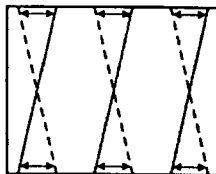

RV951 H.B SUB BOW
(horizontal blue sub bow)



RV921 H.B SKEW
(horizontal blue skew)

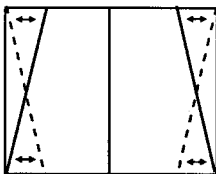

RV927 H.B KEYS
(horizontal blue trapezoid)

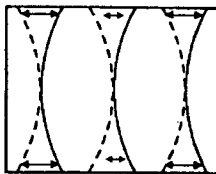

RV933 H.B BOW
(horizontal blue bow)

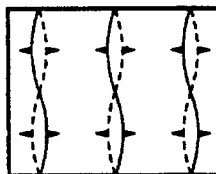

RV981
※ Common in red, green, and blue

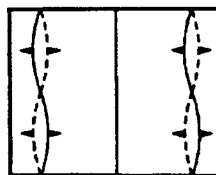

RV982
※ Common in red, green, and blue

- H/M PIN.....RV958
- M.WAVE.....RV961
- WAVE-A.....RV974
- WAVE-U.....RV977

3-9. REGISTRATION CHECK

1. Out put red, blue, and green.
2. Out put cross hatch and monoscope signals to check registration. Also check focus.

3-10. WHITE BALANCE ADJUSTMENTS

1) Screen adjustment

1. Input white signal.
2. Remove connectors CR-15, CG-16, and CB-17.
3. Fit jigs between the ground and R707, R737, and R767.

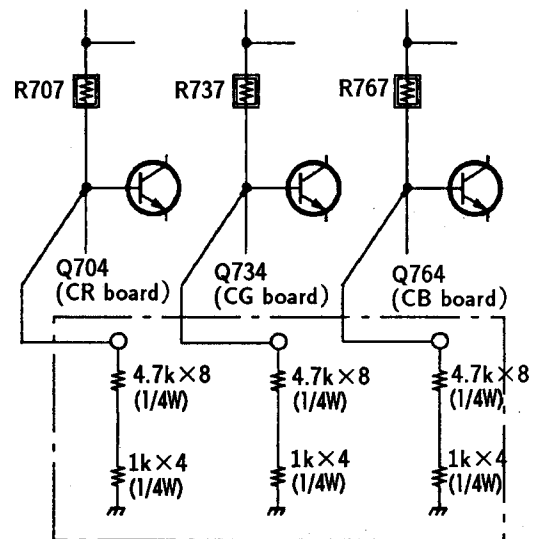

※ Resistors in each jig are connected serial.

4. Turn the RGB (red, green, and blue) screen variable resistors in the focus block to make the flyback line faint. Stop before the line completely disappears.
5. Insert connectors CR-15, CG-16, and CB-17.

2) White balance adjustments (SBRT, GAMP, BAMP, GCUT, BCUT)

1. Input monoscope signal and enter service mode.
2. Select the picture quality adjustment from the menu and set PICTURE minimum.
3. Use the commander to adjust SBRT so that 10 IRE of the monoscope pattern becomes faintly luminous.
4. Input white signal.
5. Set PICTURE minimum. Adjust item GCUT and BCUT to obtain an optimum white balance.
6. Set PICTURE maximum. Adjust GAMP and BAMP to obtain an optimum white balance.
7. Repeat white balance adjustment alternating PICTURE setting at the minimum and maximum.

MEMO

A series of horizontal dotted lines for writing.

SECTION 4

SAFETY RELATED ADJUSTMENTS

4-1. SAFETY RELATED ADJUSTMENTS

When replacing the following components, make the HV REGULATOR adjustments (on the N board)

-HV block, IC803, IC805, D805, D807, C817, C818, C821, C836, C837, R824, R825, R827, R828, R834, R835, R836, R864, R865, R866, R902

When replacing the following components, make the HV HOLD DOWN adjustments (on the N board)

-HV block, IC803, IC804, Q804, D806, D808, C809, C819, C820, C822, C823, C850, R807, R826, R829, R832, R833, R837, R838, R839, R840, R841, R892, R893, R900, R901

When replacing the following components, make the BEAM CURRENT PROTECTOR adjustments (on the N board)

-① IC802, Q805, Q807, D811, D812, C810, C824, C825, C826, C827, C831, R810, R843, R844, R847, R848, R849, R850, R851, R852, R853, R854, R881
- ② IC804, Q804, Q808, D808, D809, C809, C828, C829, C830, C831, R807, R839, R840, R841, R847, R848, R849, R850, R851, R852, R855, R856, R857, R881

When replacing the following components, make the OVP CIRCUIT adjustments (on the G board)

-Q618, Q621, D628, C634, R639, R649, R652, R655, R656

— Checking with static voltmeter —

HV HOLD DOWN ADJUSTMENTS (R900, R901)

1. Verify that the power switch is off.
2. Connect the HV hold down adjustment resistance jig to the N20 connector on the N board.

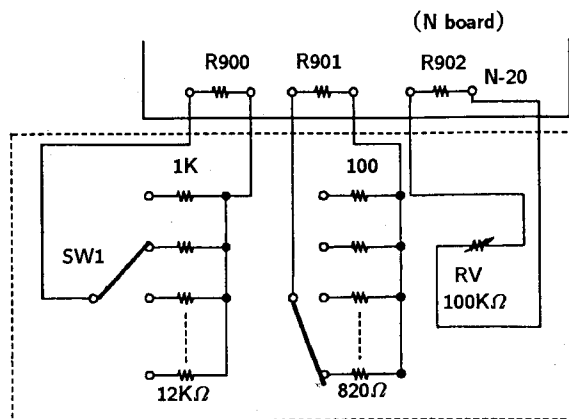

(Adjustment jig)

3. Connect an external variable resistor (RV) to R902 of the N board.
4. Remove the cap off from the unused terminal of the high voltage block. Connect a static voltmeter to the terminal.

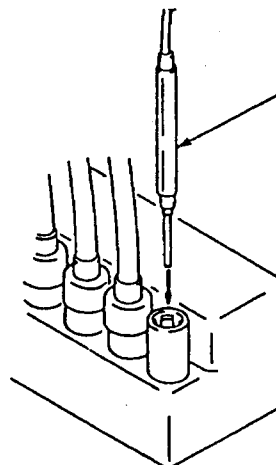

Remove high-voltage lead wire from the terminal and connect a static voltmeter there.

5. Receive 120 VAC power voltage and monoscope pattern signal. Maximize PICTURE and BRIGHTNESS.
6. Use the external variable resistor of the hold down adjustment jig to make the static voltmeter to read $33.50 \pm 0.50\text{kVDC}$.
7. Raise resistances with the jig until the HV hold down circuit is activated. Read the figures then, and mount resistance of the measured figures to R900 and R901.
R900 : Must be $1\text{k}\Omega$ to $12\text{k}\Omega$
R901 : Must be 100Ω to 820Ω
8. Turn on power again. Vary external variable resistance and confirm that the HV hold down circuit is activated at the reated value, $33.50 \pm 0.50\text{kV}$.

— Checking without static voltmeter —

HV HOLD DOWN ADJUSTMENT (R900, R901)

1. Receive all-white signal. Maximize PICTURE and BRIGHTNESS.
2. Remove R902 from the N board. Connect a variable resistor of $50k\Omega$ on each end, and minimize the resistance.
3. Remove R900 and R901 from the N board. Connect a variable resistor of $50k\Omega$ on each end, and minimize the resistance.
4. Connect a digital voltmeter between the D801 cathode and chassis ground of the N board.
5. Turn on the power switch. Adjust the variable resistors connected to the R902 of the N board to make the digital multimeter to read $145.0VDC$.
6. Adjust the variable resistors connected to R900 and R901 on the N board so as to activate the HV hold down circuit and turn off the display.
7. Read the variable resistors connected to R900 and R901 and mount fixed resistors of measured resistance to the terminals.

Note: Select fixed resistance from the following ranges.

R900 : $1k\Omega$ to $12k\Omega$

R901 : $Jw 100\Omega$ to 820Ω

8. Maximize resistance of the variable resistor connected to R902 of the N board and turn on power.
9. Vary variable resistance at R902. Confirm that the HV hold down circuit is activated and the display is turned off when voltage reads $134 \pm 1.0V$.

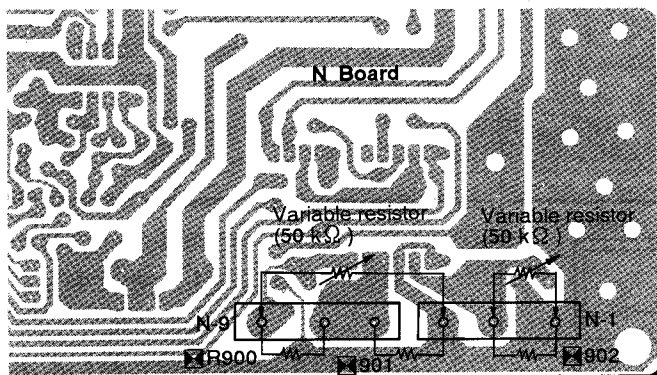

HV REGULATOR ADJUSTMENT (R902)

1. Receive all-white signal. Maximize PICTURE and BRIGHTNESS.
2. Connect a variable resistor of $50k\Omega$ on each end R902 of the N board. Maximize resistance.
3. Connect a digital voltmeter between the D80 cathode and the chassis of the N board.
4. Turn on power. Adjust the variable resistor so th the digital multimeter reads $135.0V \pm 1.0V$.
5. Read the variable resistance then.
6. Mount a fixed resistor of the measured resistance R902.

Note: R902: Must be $2.2k\Omega$ to $27k\Omega$

7. Turn on power again. Confirm that the digit multimeter reads $135.0V \pm 1.0V$.

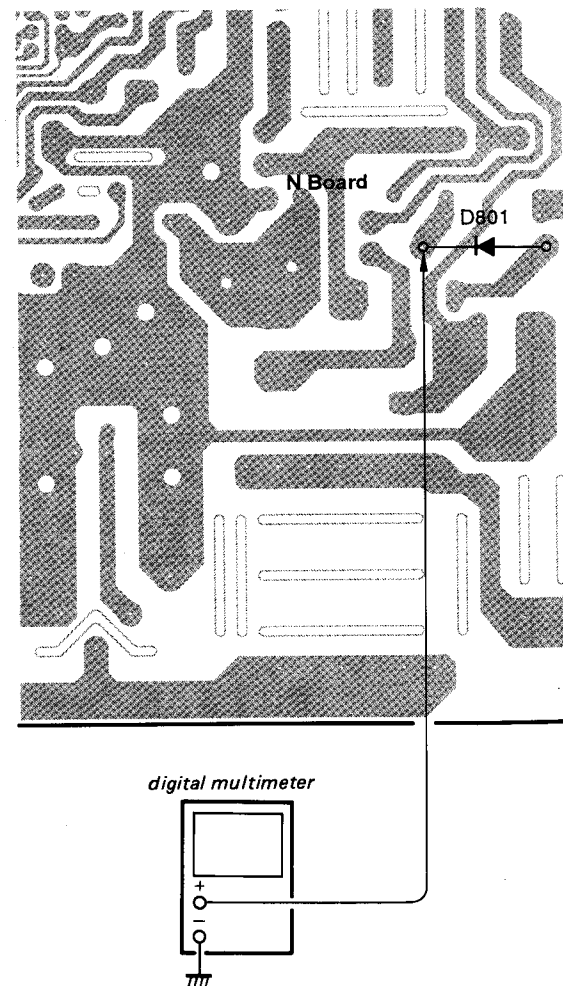

SECTION 5 CIRCUIT ADJUSTMENTS

5-1. ELECTRICAL ADJUSTMENT BY REMOTE COMMANDER

Use of Remote Commander (RM-Y114A) can be performed circuit adjustments about this model.

1. METHOD OF SETTING THE SERVICE MODE

- 1) Press **POWER** button on the Remote Commander while pressing switch on the rear of the set.

NOTE : Test Equipment Required.

1. Pattern Generator
2. Frequency counter
3. Digital multimeter
4. Audio OSC

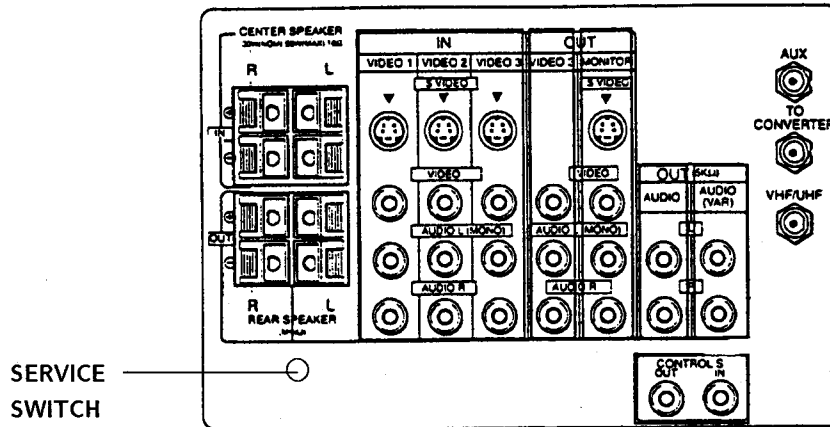

2. ADJUST BUTTONS AND INDICATOR

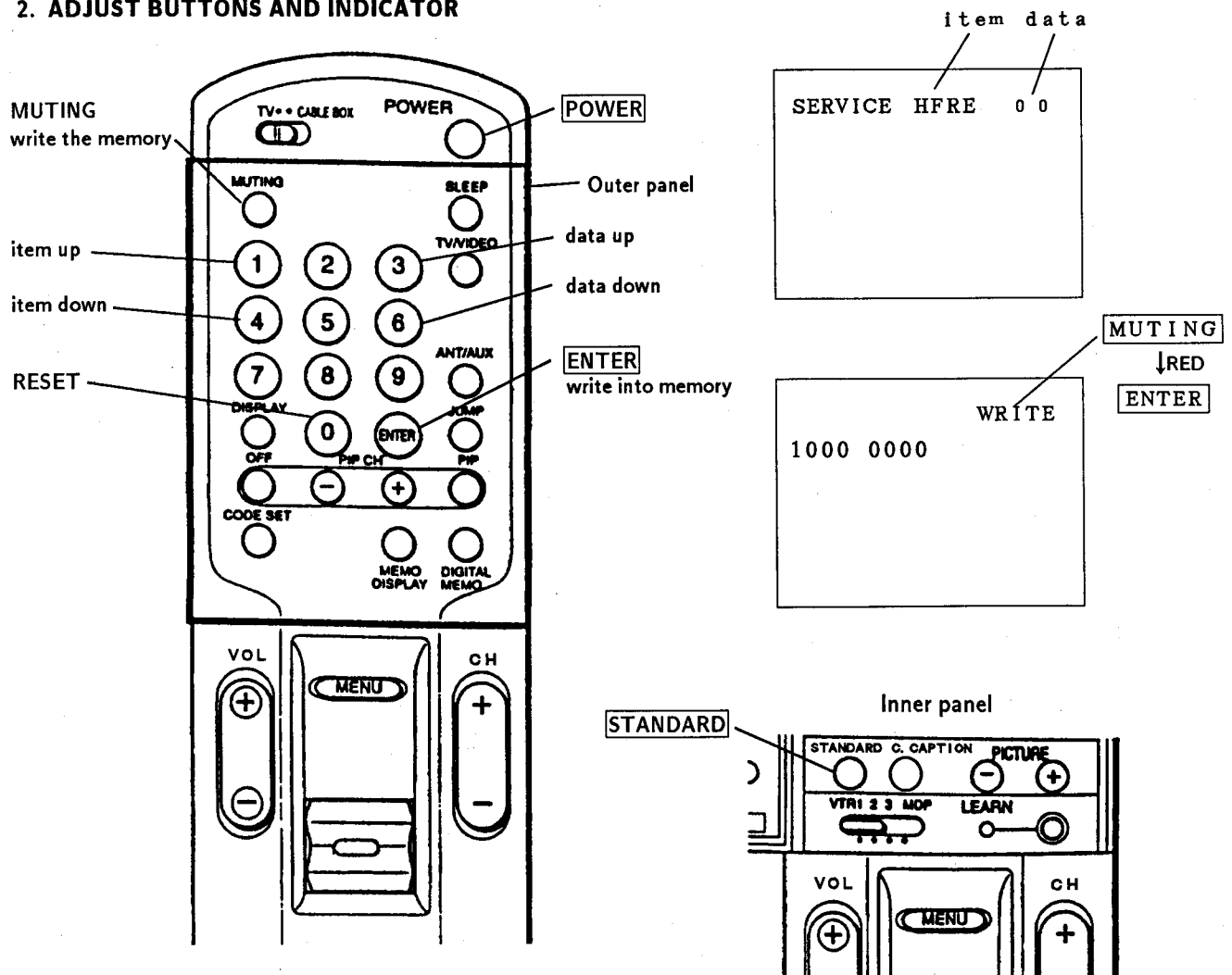

3. AN ITEM OF ADJUSTMENT

ITEM	REFERENCE DATA	NAME REGIST	
AFC	0	VP	AFC 1.0
HFRE	74	VP	H. FREQUENCE
VFRE	16	VP	V. FREQUENCE
HPOS	5	VP	H. PHASE
GAMP	25	VP	GREEN AMP.
BAMP	26	VP	BLUE AMP.
GCUT	9	VP	GREEN CUT OFF.
BCUT	6	VP	BLUE CUT OFF
SPIX	40	VP	PICTURE
SHUE	29	VP	HUE
SCOL	28	VP	COLOR
SBRT	11	VP	BRIGHT
RGBP	21	VP	RGB PICTURE
SHAR	13		SHARPNESS
DISP	21		OUTPUT
VSMO	0	VP	VSMO
REF	1	VP	REF 1.0
ROFF	1	VP	OFF NR
GOFF	1	VP	OFF NG
BOFF	1	VP	OFF NB
ABLM	1	VP	ABLM
DRGB	0	VP	D RGB
TEST	0	AP	T
MPX	7	AP	ATT
FILO	31	AP	I1
DEEM	7	AP	I2
STEV	31	AP	OSC 1
SAPV	31	AP	OSC 2
PILO	7	AP	PILOT
SEP	31	AP	WIDE BAND
VD	7	AP	SPECTRAL
LVOL	0	AP	VOLUME-L
RVOL	0	AP	VOLUME-R
BASS	10	AP	BASS
TRE	8	AP	TREBLE
PHPO	32	PI	READ DELAY H
PVPO	8	PI	READ DELAY V
PLEV	6	PI	PICTURE LEVEL
PFCO	7	PI	FRAME COLOR
NRLE	31		NR LEVEL
DSPP	43		
SHAD	1	PJ	SHADON
VMSW	1	PJ	RS HAD
SCUT	16	PJ	SHAD CUT OFF

4. METHOD OF CANCELLATION FROM SERVICE MODE

Set the standby condition (Press **POWER** button on the commander) in the next place, press **POWER** button again, hereupon it becomes TV mode.

5. METHOD OF WRITE FOR MEMORY

- 1) Set to Service Mode.
- 2) Press **1** (UP) and **4** (DOWN), select an item of adjustments.
- 3) Press **MUTING** button indicate WRITE (RED) on screen.
- 4) Press **ENTER** button to write for memory.

6. MEMORY WRITE CONFIRMATION METHOD

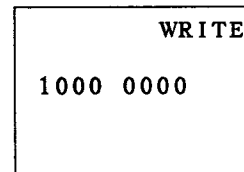

- 1) After adjustment, pull out the plug from AC outlet, and next place, plug in AC outlet again.
- 2) Turn the power switch ON and set to Service Mode.
- 3) Call the adjusted items again, confirm they were adjusted.

5-2. A BOARD ADJUSTMENTS

RF AGC ADJUSTMENT (IF BLOCK VR)

- 1) Input a color-bar signal.
- 2) Adjust AGC VR of TU 101 so that snow noise and cross-modulation disappear from the picture.
- 3) Confirm them at every channel.

H.FREQUENCY ADJUSTMENT (HFRE)

- 1) Set to Service Mode.
- 2) Input a color-bar signal.
- 3) Connect a frequency counter to pin ③ of A-10 connector.
- 4) Call the item of AFC, set to 3 level (free run).
- 5) Select HFRE with **[1]** and **[4]**.
- 6) Adjust **[3]** and **[6]** to the 15735 ± 60 Hz level.
- 7) Call the item of AFC again, adjust the level "01".
- 8) Write into the memory by pressing **[MUTING]** → then **[ENTER]**.

V.FREQUENCY ADJUSTMENT (VFRE)

- 1) Set the Service Mode.
- 2) Input an off-air signal (VIDEO IN → no signal).
- 3) Connect the frequency counter across connector ⑬ pin of E 1-1 connector and ground.
- 4) Select VFRE with **[1]** and **[4]**.
- 5) Adjust **[3]** and **[6]** to the 56 ± 0.5 Hz.
- 6) Write the memory by pressing **[MUTING]** → then **[ENTER]**.

SUB CONTRAST ADJUSTMENT (SPIX)

- 1) Set to Service Mode.
- 2) Input a color-bar signal. (75 IRE)
- 3) Set the conditions as follows.

PICTURE	MAX
COLOR	MIN
BRIGHTNESS	MIN
TRINITONE	LOW
R OFF	ON
G OFF	OFF
B OFF	OFF

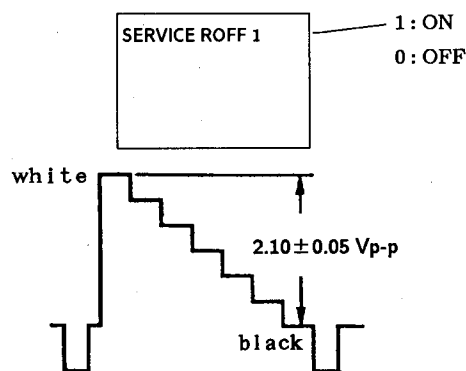

- 4) Connect an oscilloscope to ⑳ pin of E1-1 connector on A board and ground.
- 5) Adjust **[3]** and **[6]** to the 2.10 ± 0.05 Vp-p level by select-ing SPIX with **[1]** and **[4]**.
- 6) Write the memory by pressing **[MUTING]** → then **[ENTER]**.
- 7) Return the following back to normal after adjustment.

G OFF	ON
B OFF	ON
COLOR	CENTER
BRIGHTNESS	CENTER
TRINITONE	HIGH
PICTURE	80%

SUB HUE, SUB COLOR ADJUSTMENT (SHUE, SCOL)

- 1) Input a color-bar signal.
- 2) Press **STANDARD** to normal.
- 3) Set to Service Mode.
- 4) Connect an oscilloscope to pin ② of E1-1 connector on A board and ground.
- 5) Adjust ③ and ④ to the $V1=V4$ and $V2=V3$ by select to SHUE and SCOL with ① and ④. Lower the data 4 steps from this point.

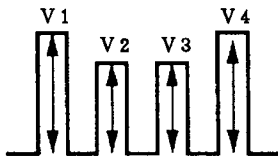

- 4) Make the data "00" by selecting FILO with ① and ④. And then, send up the data gradually by pressing ⑥. Set the data to D1 before SAT3 changing to 1 from 0.
- 5) Send up the data gradually. Set data D2 when SAT3 changes 0 from 1.
- 6) Adjust the data of FILO to $\frac{D1 + D2}{2}$.
- 7) Write into the memory by pressing **MUTING** → then **ENTER**.

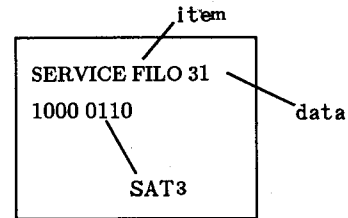

- 6) Write into the memory by pressing **MUTING** → then **ENTER**.

ST VCO ADJUSTMENT (MPX, STEV)

FILTER ADJUSTMENT (MPX, FILO)

- 1) Set to Service Mode.
- 2) Select to **TEST** with ① and ④, set the data to "1". Then select MPX and change data to "8".
- 3) Connect an audio oscillator to R224 using a capacitor (10μF/16V), set frequency to 62.936 kHz ± 0.1 kHz.

And then, through the 10kΩ resistor, feed 9.0V into the mute of TUVIF TU 101.

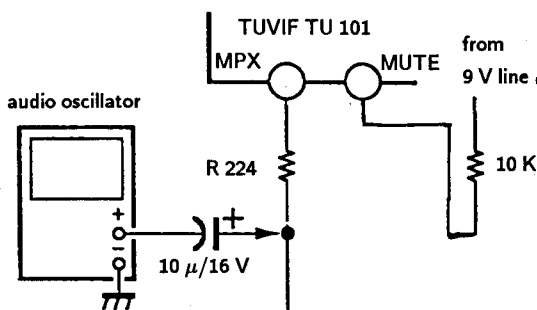

V4 fh : SINE-WAVE 62.936 KHz ± 0.1 KHz
LEVEL 3.0 Vp-p

- 1) Set to Service Mode.
- 2) Select **TEST** with ① and ④, set the data to "1". And then press **MTS** to MONO.
- 3) Select **MPX**, set the data "8".
- 4) Connect an audio oscillator to R224 using electrolytic capacitor (10μF/16V) and apply the frequency V_{st} . Then, apply DC voltage to mute of TUVIF TU 101 using 10kΩ connect to 9.0 V line.

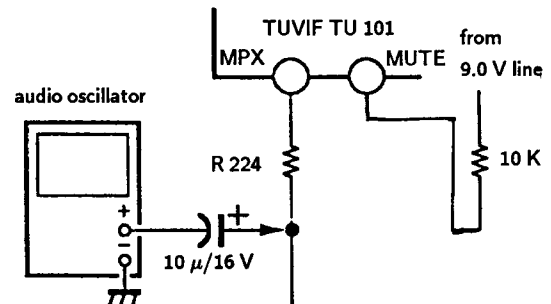

Vfh : SINE-WAVE 15.734 KHz ± 0.1 KHz
LEVEL 0.28 Vp-p

- 5) Select STEV with **1** and **4**, set the data to "00" with **6**. And then, send up the data gradually. Set the data to D1 before SAT2 changes from 0 to 1.
- 6) Send up data gradually, set the data to D2 when SAT2 changes 1 from 0.
- 7) Adjust the data of STEV to $(D1 + D2) / 2$.
- 8) Write into the memory by pressing **MUTING** → then **ENTER**.

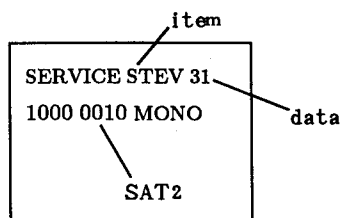

MPX IN LEVEL ADJUSTMENT (MPX)

- 1) Set to Service Mode.
- 2) Select TEST with **1** and **4**, set the data to "0" with **6**. And then press **MTS** to MONO.
- 3) Select MPX with **1** and **4**, set the data to "8" with **3** and **6**.
- 4) Write into the memory by pressing **MUTING** → then **ENTER**.

PILOT CANCEL ADJUSTMENT (PILO)

- 1) Set to the Service Mode.
- 2) Select PILO with **1** and **4**, set the data to "8" with **3** and **6**.
- 3) Write into the memory by pressing **MUTING** → then **ENTER**.

SAP VCO f₀ ADJUSTMENT (SAPV)

- 1) Set to Service Mode.
- 2) Input a stereo broadcast signal with SAP.
- 3) Select TEST with **1** and **4**, set the data to "0". And then, press **MTS** to MAIN.
- 4) Connect a digital multimeter to TP-1(DBX). This voltage reading will equal V 1.
- 5) Press MTS to SAP and this voltage will equal V 2.
- 6) Select SAPV with **1** and **4**, adjust **3** and **6** so that $V2 = V1 \pm 0.03$ VDC.
- 7) Write the memory by **MUTING** → **ENTER**.

SEPARATION ADJUSTMENT (SEP)

- 1) Set to Service Mode.
- 2) Press **MTS** to MAIN and receive a monoral broadcast signal.

In the next step, receive a stereo broadcast signal.

- 3) Select SEP and VD with **1** and **4**, adjust **3** and **6** so that a clear stereo sound is effected.

5-3. DS BOARD ADJUSTMENTS

V. 3 WAVE ADJUSTMENT (RV983)

- 1) Input a color-bar signal.
- 2) Connect an oscilloscope IC1712 Pin⑦ of DS board ground.
- 3) Adjust RV983 as shown the following figure.

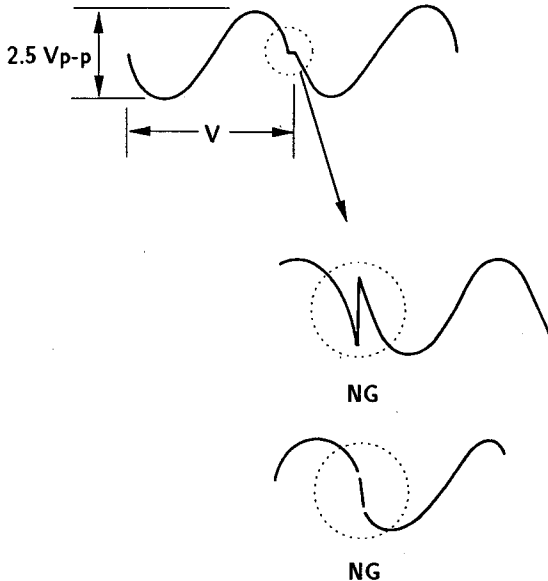

H. 3 WAVE ADJUSTMENT (RV984)

- 1) Input a color-bar signal.
- 2) Connect an oscilloscope IC1712 Pin① of DS board ground.
- 3) Adjust RV984 as shown the following figure.

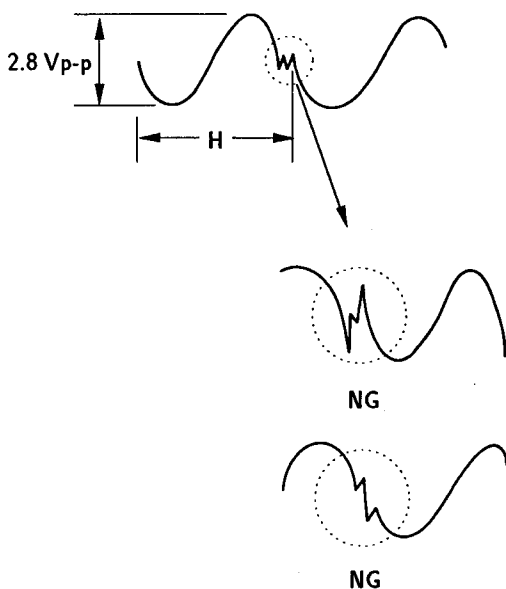

5-4. P2 BOARD ADJUSTMENTS

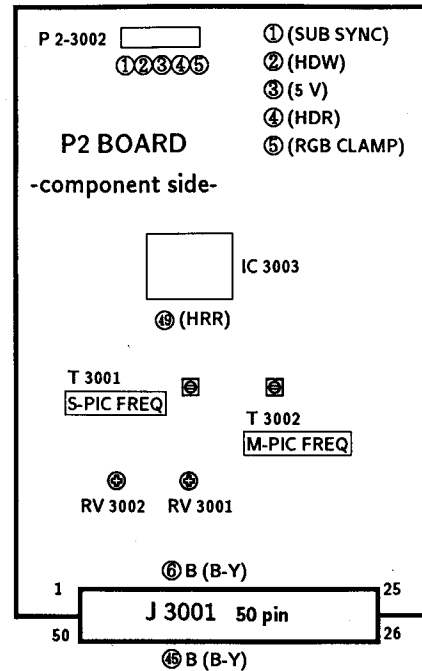

MAIN-PICTURE FREQUENCY (T 3002)

- 1) Set PIP mode.
- 2) Connect a frequency counter to Pin 11 (HDW) of J 3001.
- 3) Connect a frequency counter to Pin ④ or ⑤ (HRR) of IC 3003 or Pin 5 (RGB CLAMP) of P 2-3002.
- 4) Short the circuit between Pin 4 (HDR) of P 2-3002 and Pin 3 (5 V) of P 2-3002.
- 5) Turn T 3002 CLK (P) for the following frequency at Pin ④ or ⑤ (HRR) of IC 3003 or at Pin 5 (RGB CLAMP) of P 2-3002.

15.734 kHz ± 10 Hz

SUB-PICTURE FREQUENCY (T 3001)

- 1) Set PIP mode.
- 2) Connect a frequency counter to Pin 11 (HDW) of J 3001.
- 3) Connect a frequency counter to Pin ④ or ⑤ (HRR) of IC 3003 or Pin 5 (RGB CLAMP) of P 2-3002.
- 4) Short the circuit between Pin 1 (SUB SYNC) of P 2-3002 and Pin 3 (5 V) of P 2-3002.
- 5) Turn T 3001 CLK (C) for the following frequency at Pin 2 (HDW) of P 2-3002.

15.734 kHz ± 10 Hz

5-5. P3 BOARD ADJUSTMENTS

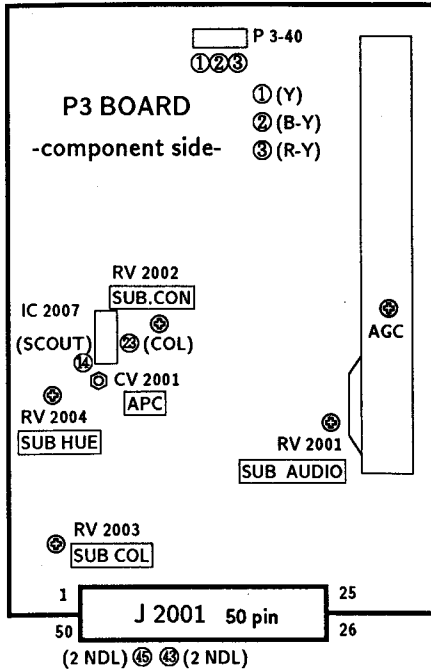

RF AGC ADJUSTMENT (IF BLOCK VR)

- 1) Input a color-bar signal.
- 2) Set to PICTURE IN PICTURE mode.
- 3) Adjust AGC VR of TU 2001 so that snow noise and cross-modulation disappear from the picture.
- 4) Confirm them at every channel.

SUB PICTURE SOUND VOLUME LEVEL (SUB AUDIO) ADJUSTMENT (RV2001)

- 1) Receive an audio signal of 400 Hz. (100% mod.)
- 2) Adjust RV 2001 for the following level at Pin 43 (2 NDR) or Pin 45 (2 NDL) of J 2001.

500 mVrms \pm 2 dB

SUB CONT ADJUSTMENT (RV2002)

- 1) Obtain the color bar signal on the sub-screen.
 - 2) Observe at Pin 1 (Y OUT) of P3-42 on an oscilloscope.
- Adjust RV2002 for the following level between the white level and pedestal one.

0.65 ± 0.05 Vp-p

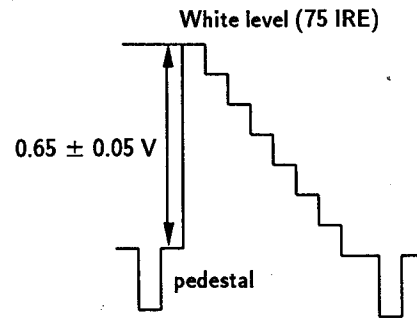

SUB COLOR ADJUSTMENT (RV 2003)

- 1) Obtain the color bar signal on the sub-screen in the mode of PIP size 1/4.
- 2) Reset color.
- 3) Adjust RV 2003 for the following level, observing an oscilloscope connected to Pin 2 (B-Y) of P3-40 (Fig. 1)

0.8 ± 0.05 Vp-p (B-Y)

- 4) Adjust RV 2003 for the following level, observing an oscilloscope connected to Pin 3 (R-Y) of P3-40 (Fig. 2)

0.75 ± 0.1 Vp-p (R-Y)

- 5) Adjust tracking between sub color and sub hue.

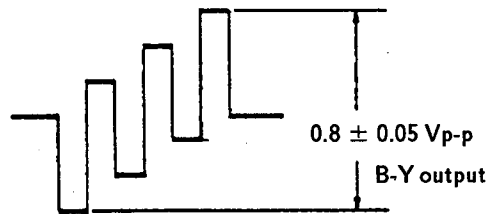

(Fig. 1)

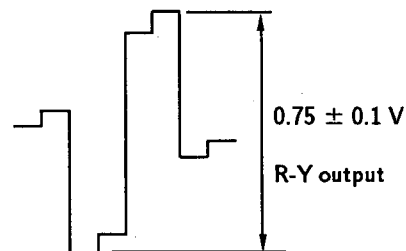

(Fig. 2)

SUB HUE ADJUSTMENT(RV 2004)

- 1) Obtain the color bar signal on the sub-screen in the mode of PIP size 1/4.
- 2) Reset hue.
- 3) Observe the signal at Pin 6 or Pin 45 of J 3001 on P 2 board on an oscilloscope and make adjustment to obtain the following level.

D : $X \pm 20 \text{ mV}$

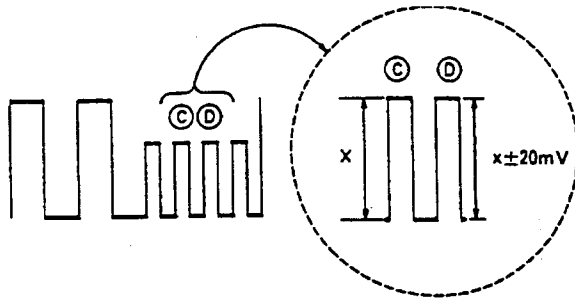

APC ADJUSTMENT(CV 2001)

Connect Pin ⑮ (COL) of IC 2007 to ground and connect a frequency counter to Pin ⑭ (SCOUT) to obtain the following level.

$3579545 \pm 40 \text{ Hz}$

A Board

IC		DIODE	
IC201	D-5	D201	G-4
IC204	D-6	D202	G-4
IC205	E-1	D203	G-9
IC206	B-6	D204	B-2
IC207	A-2	D205	E-4
IC506	G-9	D206	D-7
IC1401	C-5	D207	D-7
IC1601	F-9	D208	E-7
		D209	B-6
		D211	E-4
		D213	A-6
		D214	A-5
		D215	E-2
		D216	E-1
		D217	E-1
		D219	G-5
		D220	E-5
		D221	B-1
		D222	D-6
		D223	D-6
		D501	C-7
		D502	C-7
		D503	B-9
		D504	C-7
		D505	F-7
		D506	F-7
		D507	B-8
		D509	C-7
		D510	A-1
		D511	A-2
		D512	C-9
		D513	D-7
		D514	G-7
		D515	G-8
		D1401	A-3
		D1402	B-4
		D1403	C-7
		D1404	A-3
		D1405	A-3
		D1406	B-5
		D1407	A-4
		D1408	B-5
		D1409	A-4
		D1607	G-10
		D1608	G-10
TRANSISTOR			
Q201	C-4		
Q202	G-3		
Q203	G-9		
Q501	C-9		
Q502	B-9		
Q504	G-7		
Q505	C-9		
Q506	C-9		
Q507	D-10		
Q508	B-10		
Q509	G-8		
Q510	C-8		
Q511	A-2		
Q512	A-2		
Q1401	B-4		
Q1402	C-7		
Q1407	B-5		
Q1408	B-4		
Q1601	E-9		
Q1602	E-10		
Q1603	E-10		
Q1604	E-10		
Q1605	E-9		
Q1606	E-9		
Q1620	D-8		



NOTE:

The circuit indicated as left contains high voltage of over 600 Vp-p. Care must be paid to prevent an electric shock in inspection or repairing.

E1 [Y/C JUNGLE]

- E1 Board -
<Component Side>

E1 Board

IC	
IC301	C-5
IC302	B-4, G-4
IC303	C-3

TRANSISTOR	
Q301	C-2
Q302	C-1
Q303	G-1
Q304	A-2
Q305	B-1
Q306	H-3
Q307	C-2
Q309	F-2
Q310	D-2
Q311	B-2
Q312	B-2
Q314	B-2
Q315	G-5
Q316	G-5
Q317	E-3
Q321	D-2
Q322	G-4
Q323	F-3
Q324	G-3
Q325	G-3
Q326	D-5
Q327	G-3
Q328	F-5
Q329	C-3
Q330	C-3
Q333	D-4
Q334	D-4
Q335	D-4
Q340	E-4
Q342	D-5
Q344	D-3

DIODE	
D301	F-1
D302	G-1
D303	G-1
D304	B-3
D305	F-3
D306	C-4
D307	G-4
D310	G-4
D312	G-4
D313	G-3
D314	G-3
D315	G-2
D316	G-3
D317	B-5
D318	F-5
D319	B-5
D320	G-5
D321	B-2

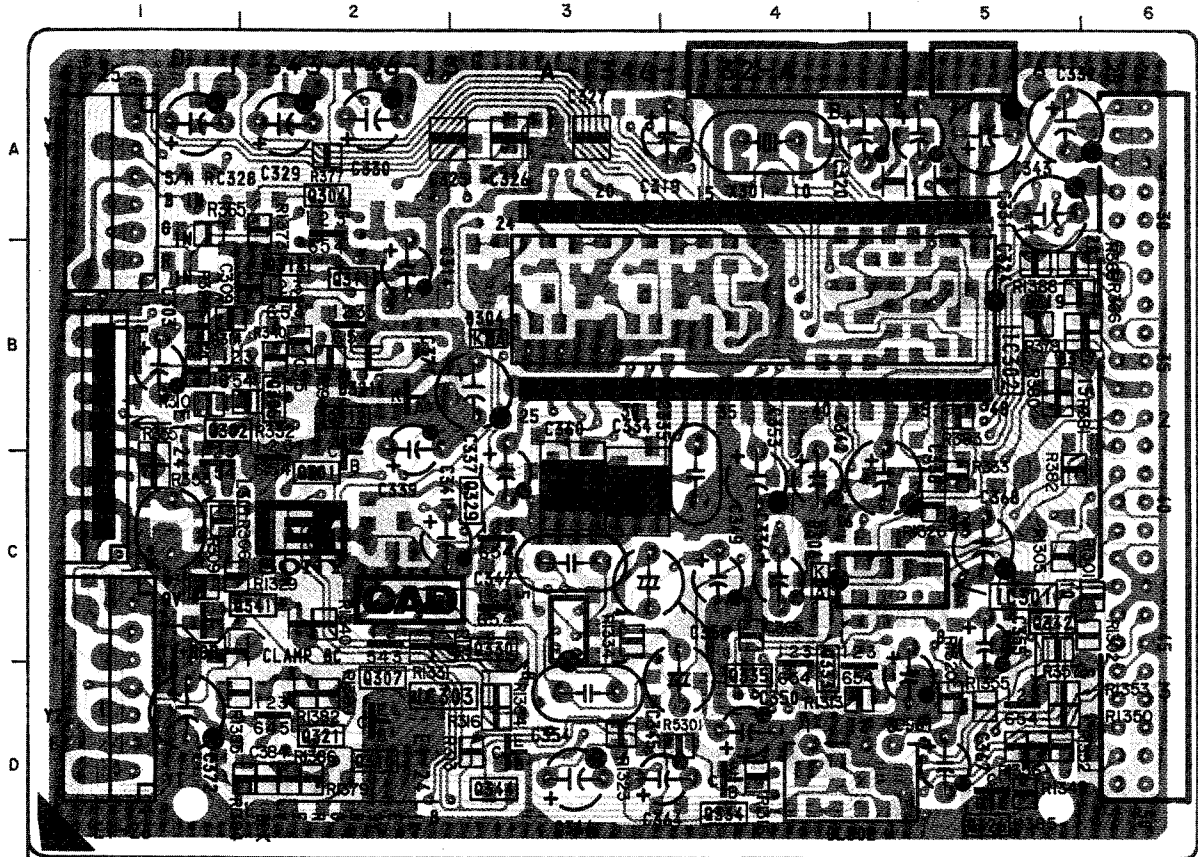

<Conductor Side>

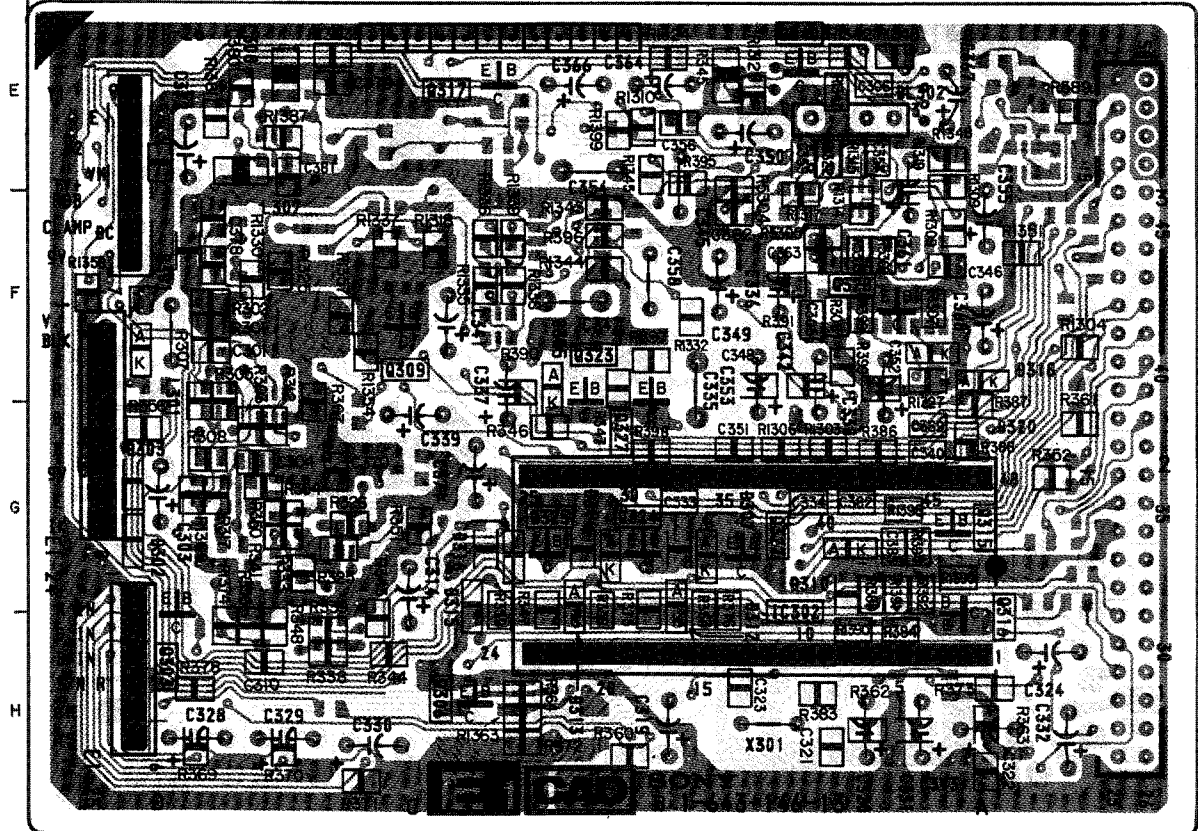

• [Cross-hatch pattern]: Pattern from the side which enables seeing.
• [Dotted pattern]: Pattern of the rear side.

E2 SHARPNESS CONT.
CHARACTOR GENERATER

- E2 Board -
<Component Side>

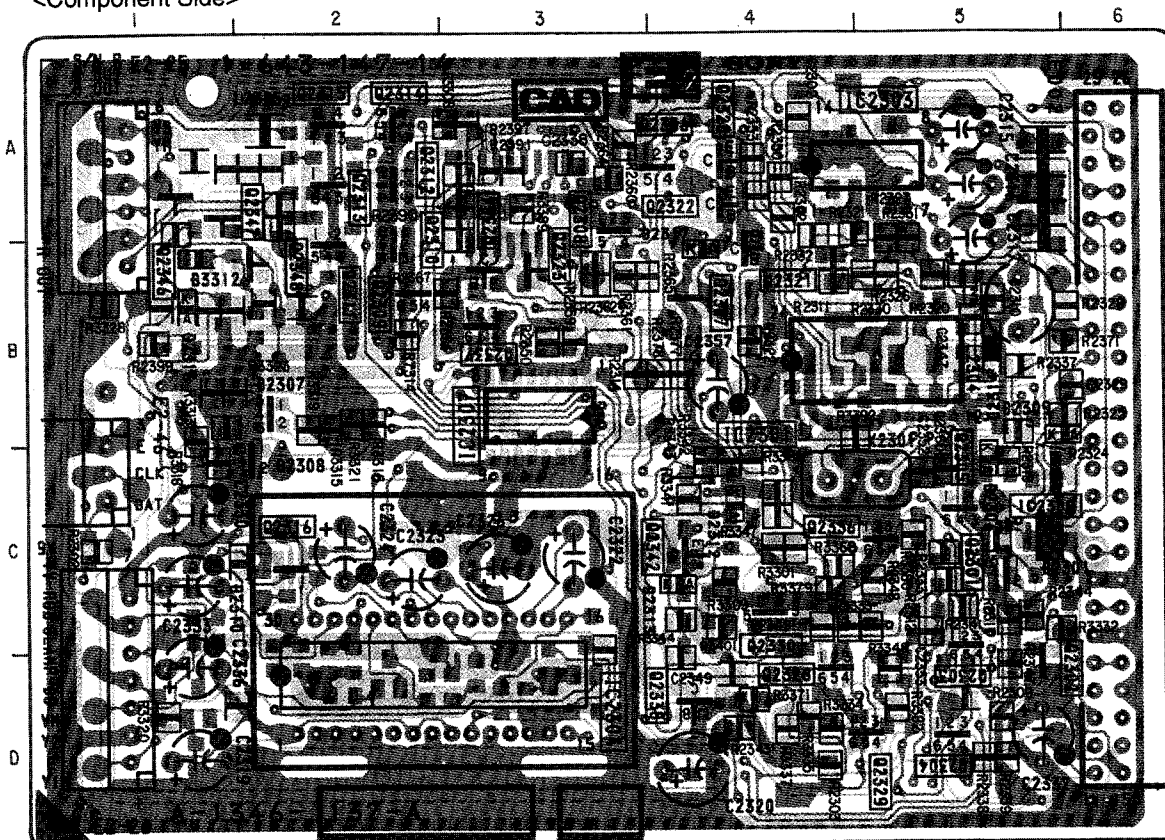

<Conductor Side>

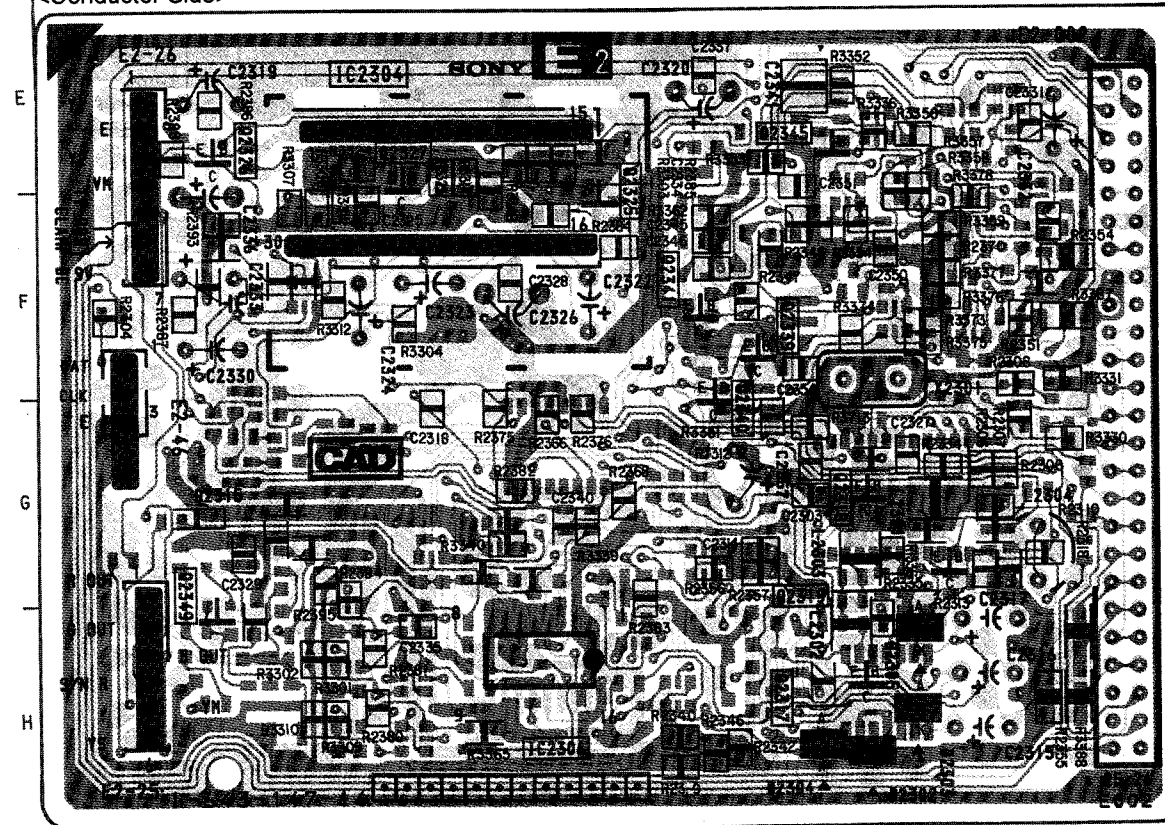

E2 Board

IC	
IC2301	B-4
IC2303	A-5
IC2304	D-3, E-2
IC2306	H-3
IC2307	B-3
TRANSISTOR	
Q2301	C-5
Q2303	C-5
Q2304	D-5
Q2305	C-5
Q2306	A-3
Q2307	B-4
Q2308	A-3
Q2309	B-2
Q2310	A-2
Q2311	A-2
Q2312	A-2
Q2313	A-2
Q2314	A-2
Q2315	A-2
Q2317	H-4
Q2318	G-4
Q2319	G-5
Q2320	A-4
Q2321	A-4
Q2322	A-4
Q2324	B-3
Q2326	E-1
Q2327	E-2
Q2330	C-4
Q2337	B-3
Q2338	D-4
Q2339	F-4
Q2340	F-4
Q2341	F-4
Q2342	C-4
Q2345	E-4
DIODE	
D2306	C-5
D2307	B-2
D2308	B-2
D2309	B-5
D2312	C-4
D2313	C-4
D2314	B-5
D2317	A-4

• : Pattern from the side which enables seeing.
• : Pattern of the rear side.

2-15-1. CONNECTOR CABLE

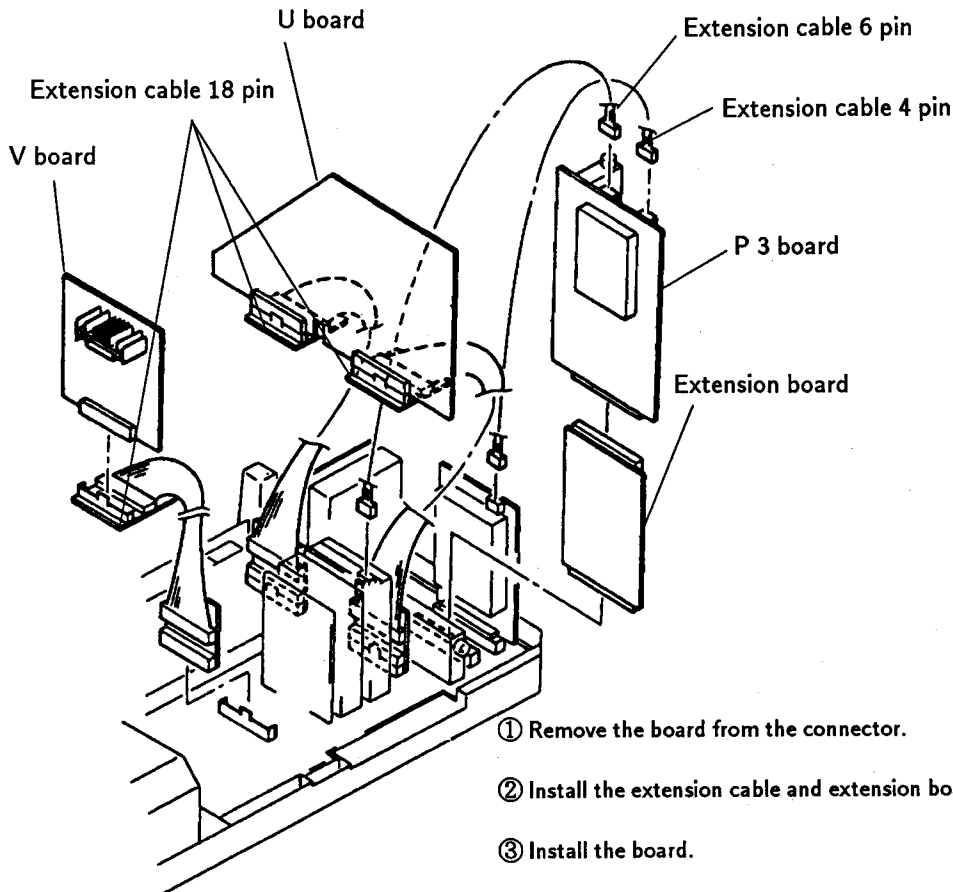

Exterior	
Extension cable	
4 pin	1-941-891-33
6 pin	1-941-891-31
7 pin	1-941-891-32
18 pin	3-702-558-01
10 pin	3-702-557-01
36 pin connector	3-702-561-01
50 pin connector	3-702-560-01
36/50 pin	3-702-559-01
Extension board	36/50 pin

2-15-2. CONNECTOR CABLE

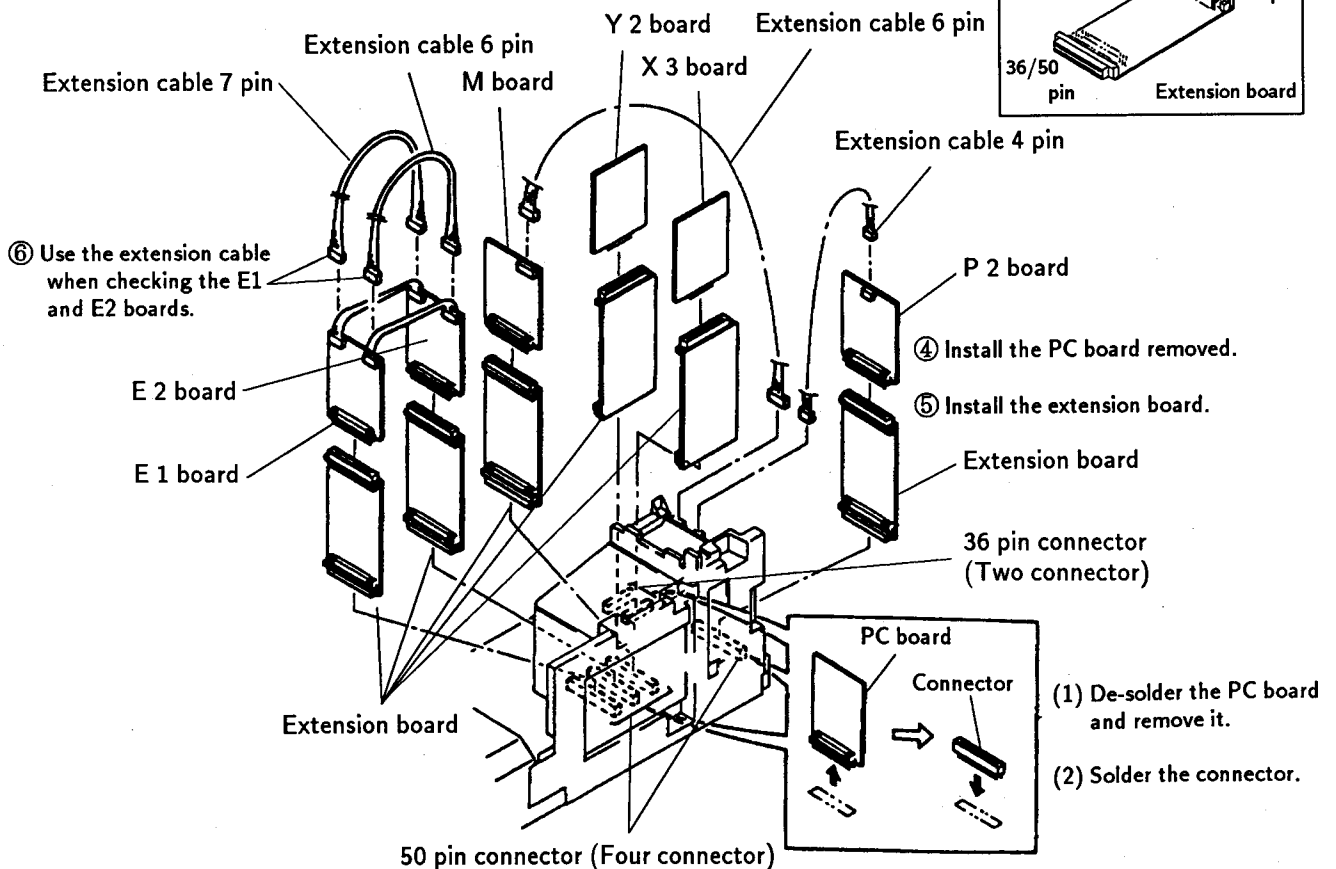

2-16. CHASSIS ASSY REMOVAL

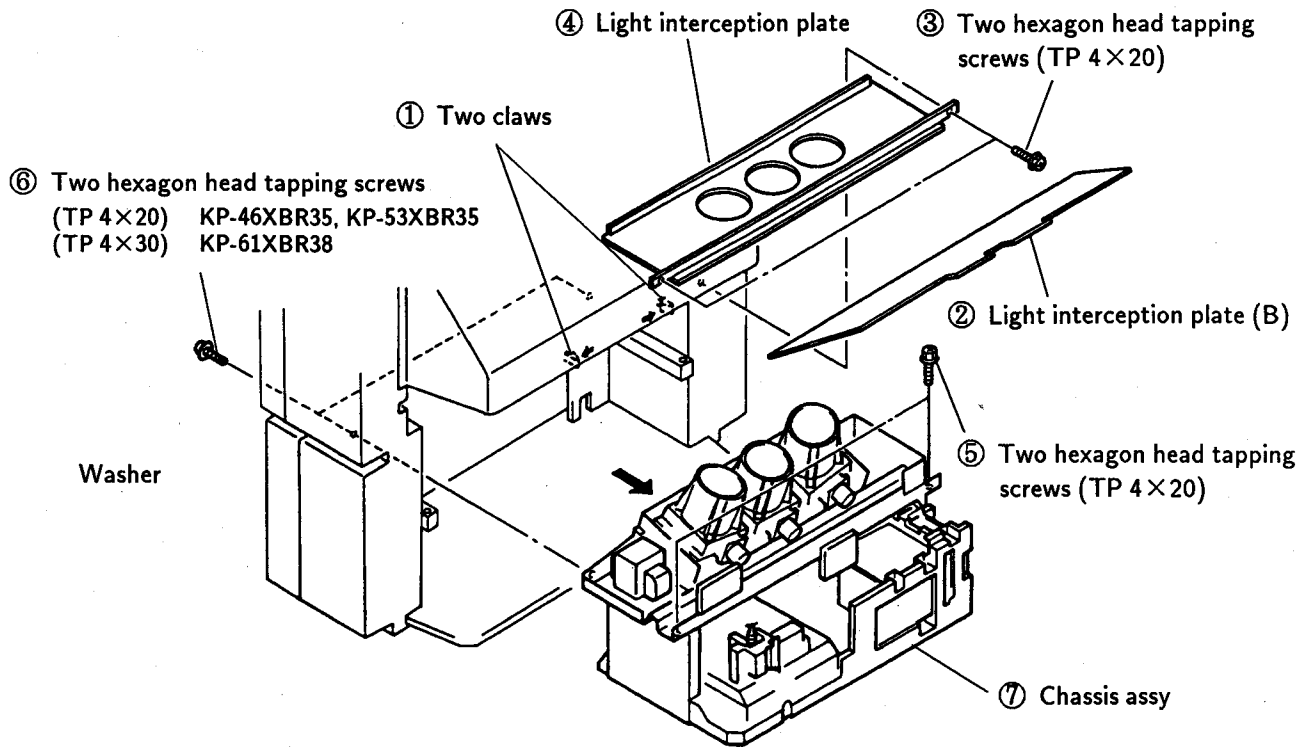

2-17. PICTURE TUBE REMOVAL

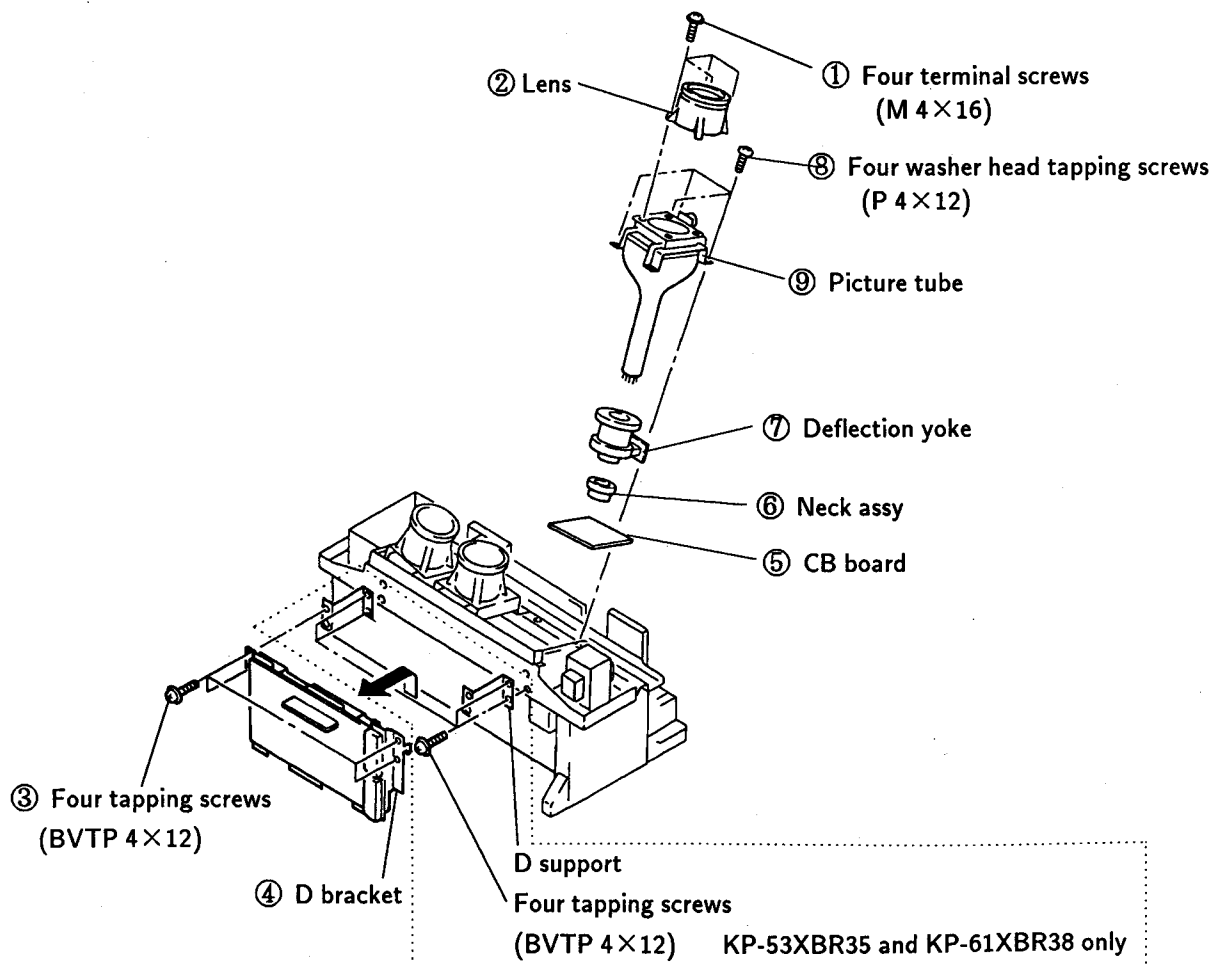

2-18. HIGH-VOLTAGE CABLE INSTALLATION AND REMOVAL

(1) Remover

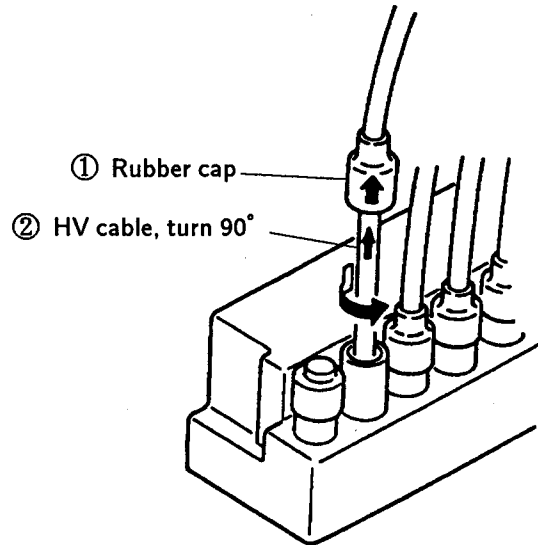

(2) Installation

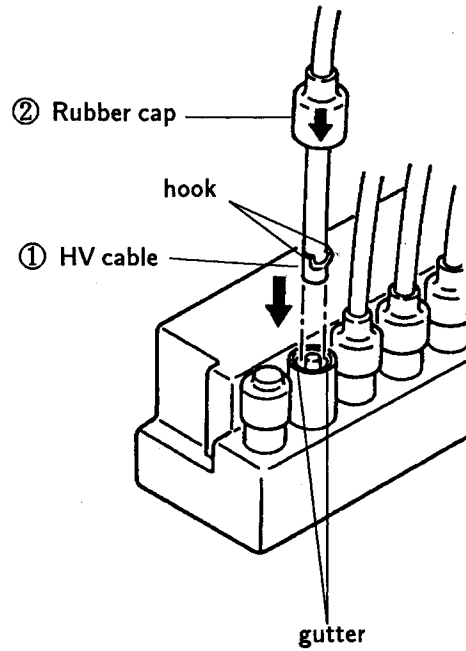

SECTION 3

SETUP ADJUSTMENTS

3-1. FOCUS LENS ADJUSTMENTS

1. Set the D-board registration variable resistors (VR) to mechanical center.
2. Set the centering magnets (for red, green, and blue) to 0 as shown in the figure.

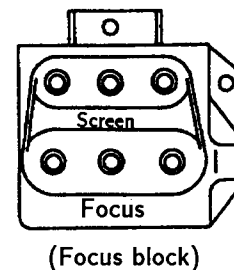
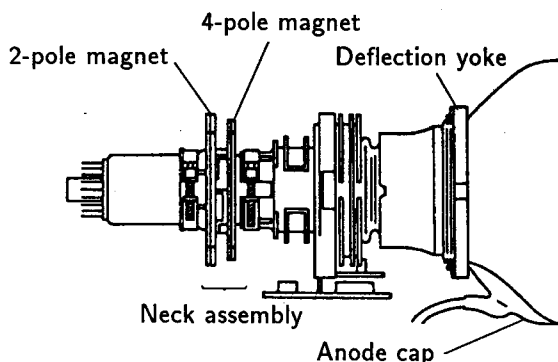

Verify that scanning lines are seen.

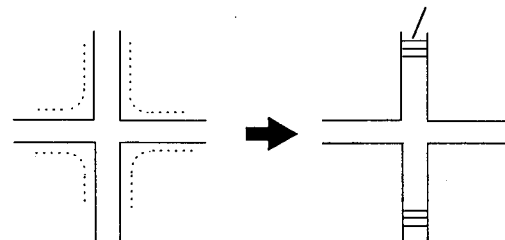

3. Input monoscope signal. Set 50% BRIGHTNESS and minimum PICTURE. Make rough adjustment so that 10IRE of the monoscope signal becomes faintly luminous using the screen VRs.
4. Set PICTURE and BRIGHTNESS maximum. Press the commander menu button. Select CONVERGENCE to display test signal.
5. Enter service mode. Select R OFF of SERVICE MODE to cut off red output. Similarly, select B OFF to cut off blue output.
6. Turn the green lens to eliminate flare of the test signal.

7. Turn the green focus VR in the focus block to adjust green focus to reduce both A and B of the test signal to minimum.

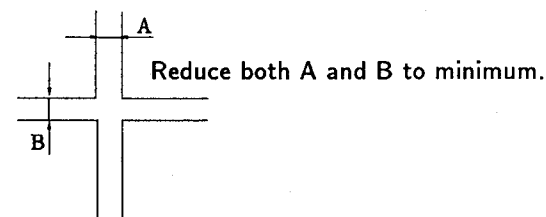

8. Repeat above 6 and 7. Couple of times to improve tracking and obtain an optimum focus. Then tighten the green lens screw.
9. Adjust the red and blue focuses similarly.

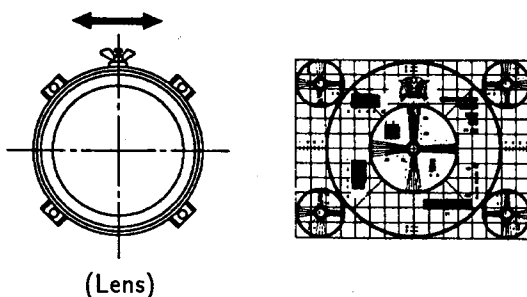

(Lens)

3-2. DEFLECTION YOKE POSITION ADJUSTMENTS

1. Input monoscope signal.
2. Enter service mode. Select R OFF of SERVICE MODE to cut off red output. Similarly, select B OFF to cut off blue output.
3. Loosen the deflection yoke (DY) fitting screws. Tilt the DY to obtain the best horizontal and vertical monoscope patterns.
4. After adjustment, press the DY onto the cathode ray tube (CRT) funnel and tighten the screws.
5. Also adjust DY positions for red and blue outputs in the same way.

3-3. 2-POLE MAGNET ADJUSTMENT

1. Input dot signal.
2. Enter service mode. Select R OFF of SERVICE MODE to cut off red output.
Similarly, select B OFF to cut off blue output.
3. Set PICTURE to maximum. Turn the green focus variable resistor (VR) in the focus block counterclockwise from the just focus to brighten the point in the dot.
4. Adjust the 2-pole magnet to position the bright point at the center of the dot.
5. Adjust the red and blue dots in the same way.

* Use the center dot:red and green
Use the vertical center and left end dot :blue

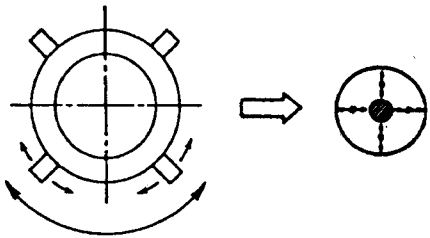

3-4. 4-POLE MAGNET ADJUSTMENT

1. Input dot signal.
2. Enter service mode. Select R OFF of SERVICE MODE to cut off red output.
Similarly, select B OFF to cut off blue output.
3. Set PICTURE to maximum. Turn the green focus variable resistor (VR) in the focus block clockwise (count clockwise:blue)from the just focus until the dot diameter becomes as shown below.
4. Adjust the 2-pole magnet to make the dot perfectly round.
5. Turn the green focus variable resistor to the just focus.
6. Adjust the red and blue dot in the same way.

* Use the center dot : red and green
Use the vertical center and left end dot : blue

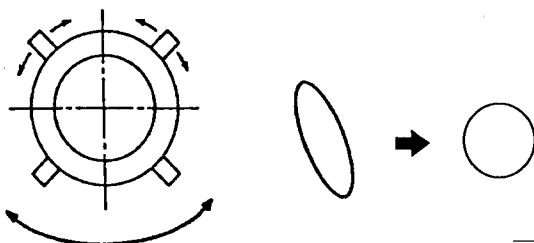

3-5. DE-FOCUS ADJUSTMENT (BLUE)

1. Input cross hatch signal.
2. Turn the blue focus variable resistor (VR) in the focus block counter clock wise so that thewidth of the left end vertical line becomes as shown below.

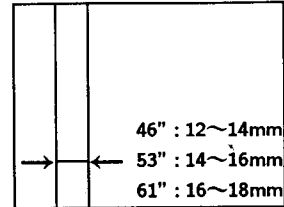

without flare

3-6. GREEN PICTURE ADJUSTMENTS

1. Input monoscope signal.
2. Enter service mode. Select R OFF of SERVICE MODE to cut off red output.
Similarly, select B OFF to cut off blue output.
3. Turn RV913 and RV960, the vertical green linearity variable resistors (V.G LIN VRs) on the D-board, to obtain an optimum vertical linearity.
Then turn RV911, the vertical green amplitude variable resistor (V.G SIZE VR) to set vertical amplitude to 11.7 flames.

Note: The vertical position indicator of the monoscope signal must be positioned at the center by adjusting RV905, the vertical green center position variable resistor (V.G CENT VR) in advance.

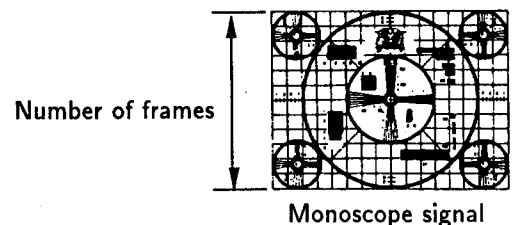

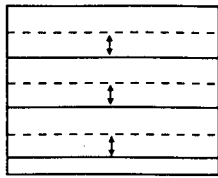

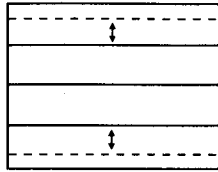

RV905 V.G CENT
(vertical position)



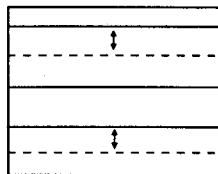

RV911 V.G SIZE
(vertical amplitude)

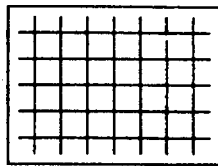

RV913 V.G LIN
(vertical linearity)

5. Verify that the horizontal lines on the top and bottom of cross-hatched area of the monoscope signal are horizontal and linear.



6. Turn RV916, RV964 and RV969, the horizontal green linearity variable resistors (H.G LIN VRs) on the D-board, to obtain an optimum horizontal linearity.

Then turn RV908, the horizontal green amplitude variable resistor (H.G SIZE VR) to set horizontal amplitude to 15.6 frames.

Note: The horizontal position indicator of the monoscope signal must be positioned at the center by adjusting RV902, the horizontal green center position variable resistor (V.G CENT VR) in advance.

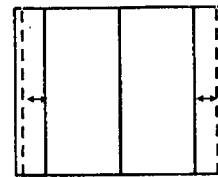
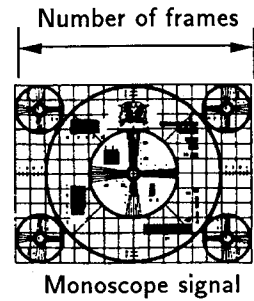

RV908 H.G SIZE
(horizontal position)

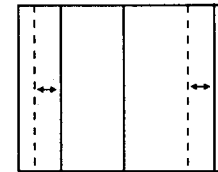

RV916 H.G LIN
(horizontal linearity)

7. Input cross hatch signal.

Turn vertical green (V.G) and horizontal green (H.G) variable resistors (VRs) and make adjustments according to the following steps :

(Adjustment procedure)

1. [BOW] → [SKEW] → [CENT (center position)]
2. [PIN (pin warp)] → [SUB BOW] → [BOW]
3. [KEYS (trapezoid)] → [SUB SKEW] → [SKEW]
4. [M.WAVE (middle sine wave warp)] → [WAVE-A (upper and lower sine wave warp)] → [WAVE-U (upper sine wave warp)]
※ For vertical (V) only.
5. [V-M.PIN (vertical middle pin warp)] → [V/WING (vertical wing warp)]
※ For vertical (V) only.
6. [H-M.PIN (horizontal middle pin warp)]
※ For horizontal (H) only.

(Dot motion)

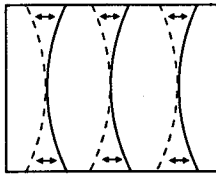

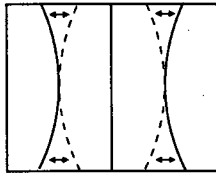

RV932 H.G BOW
(horizontal green bow)



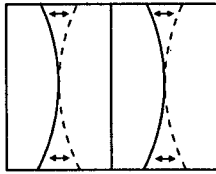

RV941 H.G PIN
(horizontal green pin warp)

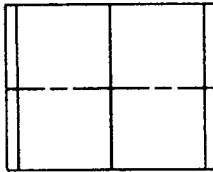



RV950 H.G SUB BOW
(horizontal green sub bow)

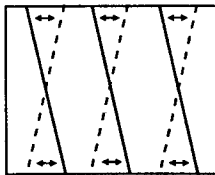

- V.G BOW.....RV935
- V.G PIN.....RV938
- V.G SUB BOW.....RV953



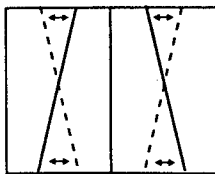

RV920 H.G SKEW
(horizontal green skew)



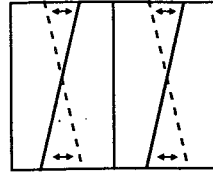

RV925 H.G KEYS
(horizontal green trapezoid)

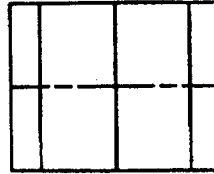



RV944 H.G SUB SKEW
(horizontal green sub skew)

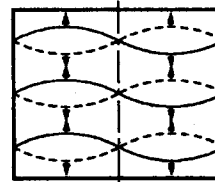

- V.G SKEW.....RV923
- V.G KEYS.....RV929
- V.G SUB SKEW.....RV947



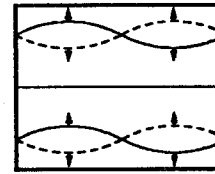

RV962 V-M-WAVE
(vertical middle sine wave warp)



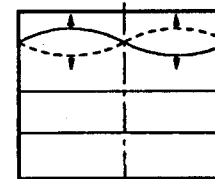

RV975 V-WAVE-A
(vertical upper and lower
sine wave warp)

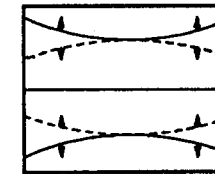



RV978 V-WAVE-U
(vertical upper sine wave warp)

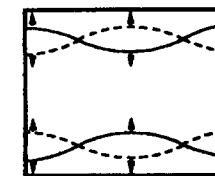



RV980 V-M. PIN
(vertical middle pin warp)
* Common in red, green,
and blue

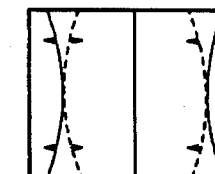

RV957 V/WING
(wing warp)
* Common in red, green,
and blue



RV956 H/M. PIN
(horizontal middle pin warp)

3-7. GREEN AND RED REGISTRATION ADJUSTMENTS

1. Input cross hatch signal.
2. Enter service mode. Select B OFF of SERVICE MODE to cut off blue output.
3. Turn the vertical red (V.R) and horizontal red (H.R) variable resistors (VRs) to adjust red picture convergence in relation to green picture according to the following steps :

(Adjustment procedure)

1. [LIN (linearity)] → [SIZE (amplitude)] → [CENT (center position)]
2. [BOW] → [SKEW] → [CENT (center position)]
3. [PIN (pin warp)] → [SUB BOW] → [BOW] [H/M. PIN (horizontal middle pin warp)]
4. [KEYS (trapezoid)] → [SUB SKEW] → [SKEW]
5. [M.WAVE (middle sine wave warp)] → [WAVE-A (upper and lower sine wave warp)] → [WAVE-U (upper sine wave warp)]

(Dot motion)

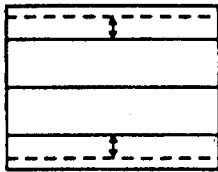

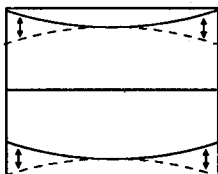

RV912 V.B SIZE
(vertical red amplitude)



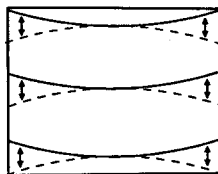

RV952 V.R SUB BOW
(vertical red sub bow)

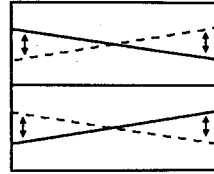



RV943 V.R BOW
(vertical red bow)

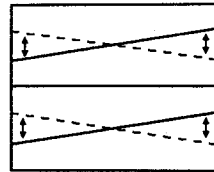



RV928 V.R KEYS
(vertical red trapezoid)

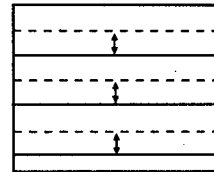



RV946 V.R SUB SKEW
(vertical red sub skew)

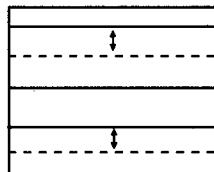

RV904 V.R CENT
(vertical red center position)

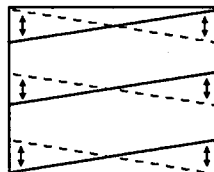

RV917 V.R LIN
(vertical red linearity)



RV922 V.R SKEW
(vertical red skew)

H.R LIN	RV915
H.R SIZE	RV907
H.R CENT	RV901
H.R BOW	RV931
H.R SKEW	RV919
H.R PIN	RV940
H.R KEYS	RV926
H.R SUB BOW	RV949
H.R SUB SKEW	RV943
V-M-WAVE	RV973
V-WAVE-A	RV976
V-WAVE-U	RV979
V-M.PIN	RV980
V/WING	RV957
H/M.PIN	RV956

3-8. GREEN AND BLUE REGISTRATION ADJUSTMENTS

1. Input cross hatch signal.
2. Enter service mode. Select R OFF of SERVICE MODE to cut off red output.
3. Turn the vertical blue (V.B) and horizontal blue (H.B) variable resistors (VRs) to adjust blue picture convergence in relation to green picture according to the following steps :

(Adjustment procedure)

1. [LIN (linearity)] → [SIZE (amplitude)] → [CENT (center position)] →
2. [BOW] → [SKEW] → [CENT (center position)]
3. [PIN (pin warp)] → [SUB BOW] → [BOW] [H/M. PIN (horizontal middle pin warp)]
4. [KEYS (trapezoid)] → [SUB SKEW] → [SKEW]
5. [M.WAVE (middle sine wave warp)] → [WAVE-A (upper and lower sine wave warp)] → [WAVE-U (upper sine wave warp)] →

(Dot motion)

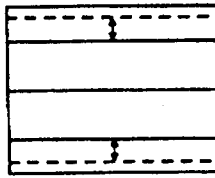

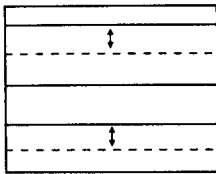

RV912 V.B SIZE
(vertical blue amplitude)



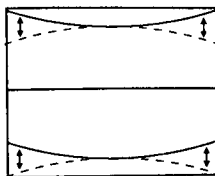

RV918 V.B LIN
(vertical blue linearity)

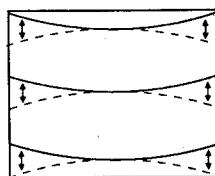



RV954 V.B SUB BOW
(horizontal blue sub bow)

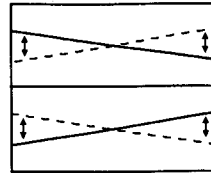



RV936 V.B BOW
(vertical blue bow)

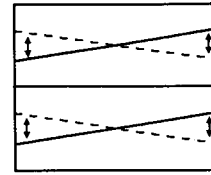



RV930 V.B KEYS
(vertical blue trapezoid)

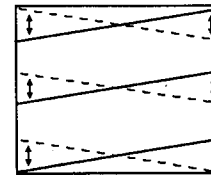



RV948 V.B SUB SKEW
(vertical blue sub skew)

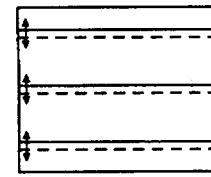



RV924 V.B SKEW
(vertical blue skew)

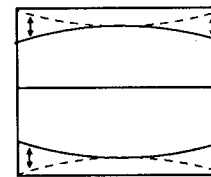



RV906 V.B CENT
(vertical blue center position)

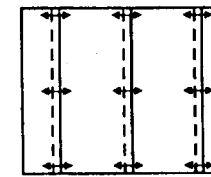



RV939 V.B PIN
(vertical blue pin warp)

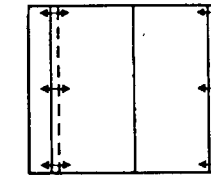



RV903 H.B CENT
(vertical blue center position)

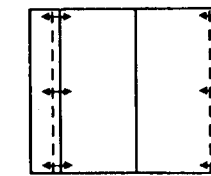



RV909 H.B SIZE
(horizontal blue amplitude)

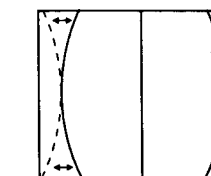



RV914 H.B LIN
(horizontal blue linearity)

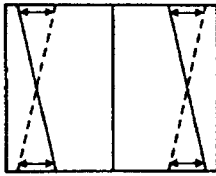



RV942 H.B PIN
(horizontal blue pin warp)

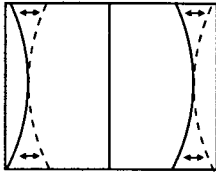

RV954 H.B SUB SKEW
(horizontal blue sub skew)

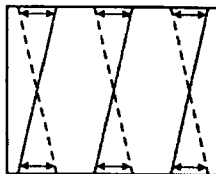

RV951 H.B SUB BOW
(horizontal blue sub bow)



RV921 H.B SKEW
(horizontal blue skew)

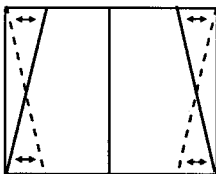

RV927 H.B KEYS
(horizontal blue trapezoid)

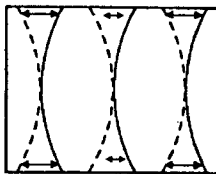

RV933 H.B BOW
(horizontal blue bow)

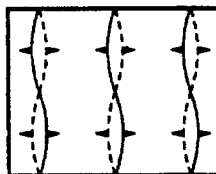

RV981
※ Common in red, green, and blue

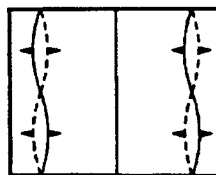

RV982
※ Common in red, green, and blue

- H/M PIN.....RV958
- M.WAVE.....RV961
- WAVE-A.....RV974
- WAVE-U.....RV977

3-9. REGISTRATION CHECK

1. Out put red, blue, and green.
2. Out put cross hatch and monoscope signals to check registration. Also check focus.

3-10. WHITE BALANCE ADJUSTMENTS

1) Screen adjustment

1. Input white signal.
2. Remove connectors CR-15, CG-16, and CB-17.
3. Fit jigs between the ground and R707, R737, and R767.

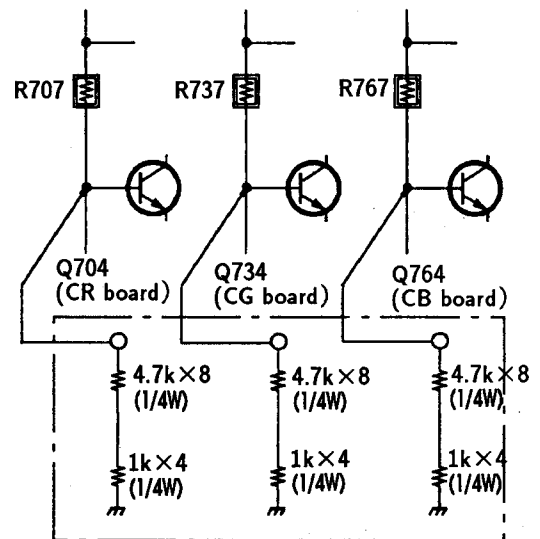

※ Resistors in each jig are connected serial.

4. Turn the RGB (red, green, and blue) screen variable resistors in the focus block to make the flyback line faint. Stop before the line completely disappears.
5. Insert connectors CR-15, CG-16, and CB-17.

2) White balance adjustments (SBRT, GAMP, BAMP, GCUT, BCUT)

1. Input monoscope signal and enter service mode.
2. Select the picture quality adjustment from the menu and set PICTURE minimum.
3. Use the commander to adjust SBRT so that 10 IRE of the monoscope pattern becomes faintly luminous.
4. Input white signal.
5. Set PICTURE minimum. Adjust item GCUT and BCUT to obtain an optimum white balance.
6. Set PICTURE maximum. Adjust GAMP and BAMP to obtain an optimum white balance.
7. Repeat white balance adjustment alternating PICTURE setting at the minimum and maximum.

MEMO

A series of horizontal dotted lines for writing.

SECTION 4

SAFETY RELATED ADJUSTMENTS

4-1. SAFETY RELATED ADJUSTMENTS

When replacing the following components, make the HV REGULATOR adjustments (on the N board)

-HV block, IC803, IC805, D805, D807, C817, C818, C821, C836, C837, R824, R825, R827, R828, R834, R835, R836, R864, R865, R866, R902

When replacing the following components, make the HV HOLD DOWN adjustments (on the N board)

-HV block, IC803, IC804, Q804, D806, D808, C809, C819, C820, C822, C823, C850, R807, R826, R829, R832, R833, R837, R838, R839, R840, R841, R892, R893, R900, R901

When replacing the following components, make the BEAM CURRENT PROTECTOR adjustments (on the N board)

-① IC802, Q805, Q807, D811, D812, C810, C824, C825, C826, C827, C831, R810, R843, R844, R847, R848, R849, R850, R851, R852, R853, R854, R881
- ② IC804, Q804, Q808, D808, D809, C809, C828, C829, C830, C831, R807, R839, R840, R841, R847, R848, R849, R850, R851, R852, R855, R856, R857, R881

When replacing the following components, make the OVP CIRCUIT adjustments (on the G board)

-Q618, Q621, D628, C634, R639, R649, R652, R655, R656

— Checking with static voltmeter —

HV HOLD DOWN ADJUSTMENTS (R900, R901)

1. Verify that the power switch is off.
2. Connect the HV hold down adjustment resistance jig to the N20 connector on the N board.

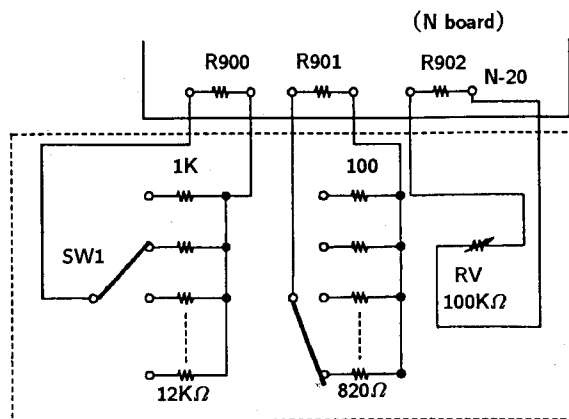

(Adjustment jig)

3. Connect an external variable resistor (RV) to R902 of the N board.
4. Remove the cap off from the unused terminal of the high voltage block. Connect a static voltmeter to the terminal.

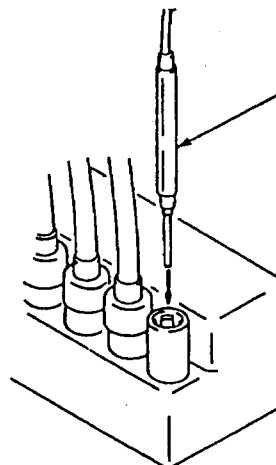

Remove high-voltage lead wire from the terminal and connect a static voltmeter there.

5. Receive 120 VAC power voltage and monoscope pattern signal. Maximize PICTURE and BRIGHTNESS.
6. Use the external variable resistor of the hold down adjustment jig to make the static voltmeter to read $33.50 \pm 0.50\text{kVDC}$.
7. Raise resistances with the jig until the HV hold down circuit is activated. Read the figures then, and mount resistance of the measured figures to R900 and R901.
R900 : Must be $1\text{k}\Omega$ to $12\text{k}\Omega$
R901 : Must be 100Ω to 820Ω
8. Turn on power again. Vary external variable resistance and confirm that the HV hold down circuit is activated at the reated value, $33.50 \pm 0.50\text{kV}$.

— Checking without static voltmeter —

HV HOLD DOWN ADJUSTMENT (R900, R901)

1. Receive all-white signal. Maximize PICTURE and BRIGHTNESS.
2. Remove R902 from the N board. Connect a variable resistor of $50k\Omega$ on each end, and minimize the resistance.
3. Remove R900 and R901 from the N board. Connect a variable resistor of $50k\Omega$ on each end, and minimize the resistance.
4. Connect a digital voltmeter between the D801 cathode and chassis ground of the N board.
5. Turn on the power switch. Adjust the variable resistors connected to the R902 of the N board to make the digital multimeter to read $145.0VDC$.
6. Adjust the variable resistors connected to R900 and R901 on the N board so as to activate the HV hold down circuit and turn off the display.
7. Read the variable resistors connected to R900 and R901 and mount fixed resistors of measured resistance to the terminals.

Note: Select fixed resistance from the following ranges.

R900: $1k\Omega$ to $12k\Omega$

R901: 100Ω to 820Ω

8. Maximize resistance of the variable resistor connected to R902 of the N board and turn on power.
9. Vary variable resistance at R902. Confirm that the HV hold down circuit is activated and the display is turned off when voltage reads $134 \pm 1.0V$.

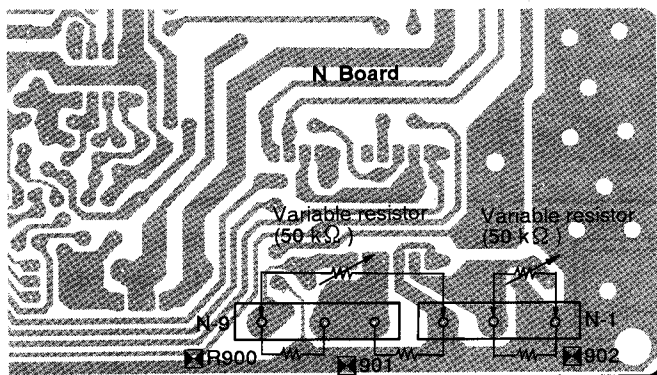

HV REGULATOR ADJUSTMENT (R902)

1. Receive all-white signal. Maximize PICTURE and BRIGHTNESS.
2. Connect a variable resistor of $50k\Omega$ on each end R902 of the N board. Maximize resistance.
3. Connect a digital voltmeter between the D80 cathode and the chassis of the N board.
4. Turn on power. Adjust the variable resistor so that the digital multimeter reads $135.0V \pm 1.0V$.
5. Read the variable resistance then.
6. Mount a fixed resistor of the measured resistance R902.

Note: R902: Must be $2.2k\Omega$ to $27k\Omega$

7. Turn on power again. Confirm that the digital multimeter reads $135.0V \pm 1.0V$.

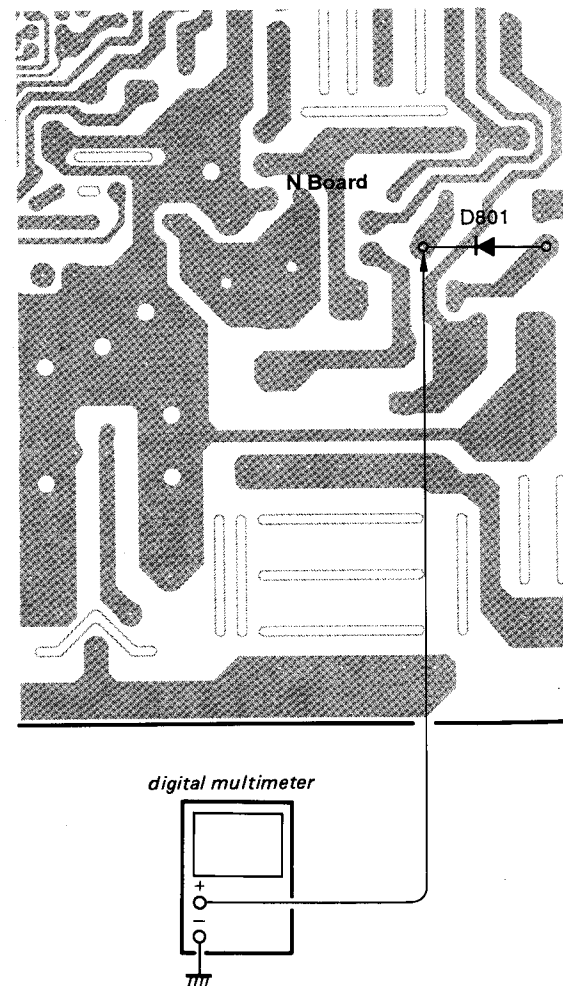

SECTION 5 CIRCUIT ADJUSTMENTS

5-1. ELECTRICAL ADJUSTMENT BY REMOTE COMMANDER

Use of Remote Commander (RM-Y114A) can be performed circuit adjustments about this model.

NOTE : Test Equipment Required.

1. METHOD OF SETTING THE SERVICE MODE

- 1) Press **POWER** button on the Remote Commander while pressing switch on the rear of the set.

1. Pattern Generator
2. Frequency counter
3. Digital multimeter
4. Audio OSC

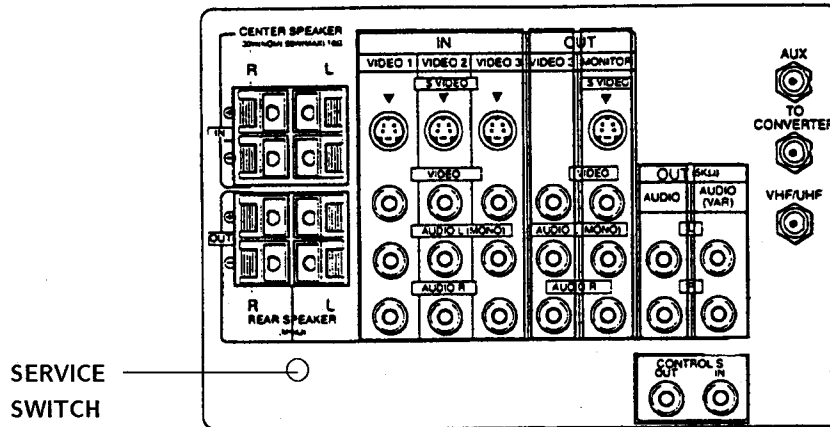

2. ADJUST BUTTONS AND INDICATOR

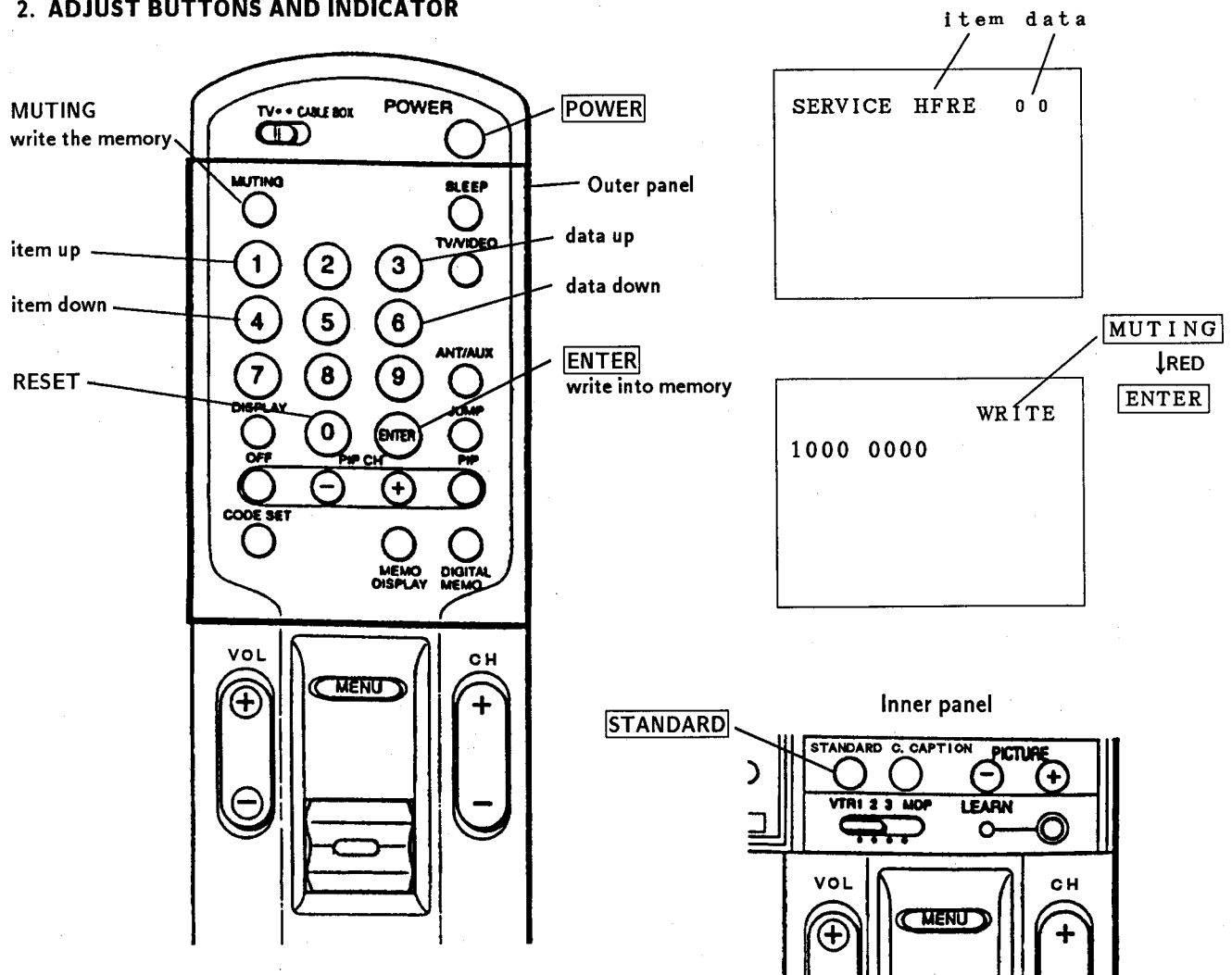

3. AN ITEM OF ADJUSTMENT

ITEM	REFERENCE DATA	NAME REGIST	
AFC	0	VP	AFC 1.0
HFRE	74	VP	H. FREQUENCE
VFRE	16	VP	V. FREQUENCE
HPOS	5	VP	H. PHASE
GAMP	25	VP	GREEN AMP.
BAMP	26	VP	BLUE AMP.
GCUT	9	VP	GREEN CUT OFF.
BCUT	6	VP	BLUE CUT OFF
SPIX	40	VP	PICTURE
SHUE	29	VP	HUE
SCOL	28	VP	COLOR
SBRT	11	VP	BRIGHT
RGBP	21	VP	RGB PICTURE
SHAR	13		SHARPNESS
DISP	21		OUTPUT
VSMO	0	VP	VSMO
REF	1	VP	REF 1.0
ROFF	1	VP	OFF NR
GOFF	1	VP	OFF NG
BOFF	1	VP	OFF NB
ABLM	1	VP	ABLM
DRGB	0	VP	D RGB
TEST	0	AP	T
MPX	7	AP	ATT
FILO	31	AP	I1
DEEM	7	AP	I2
STEV	31	AP	OSC 1
SAPV	31	AP	OSC 2
PILO	7	AP	PILOT
SEP	31	AP	WIDE BAND
VD	7	AP	SPECTRAL
LVOL	0	AP	VOLUME-L
RVOL	0	AP	VOLUME-R
BASS	10	AP	BASS
TRE	8	AP	TREBLE
PHPO	32	PI	READ DELAY H
PVPO	8	PI	READ DELAY V
PLEV	6	PI	PICTURE LEVEL
PFCO	7	PI	FRAME COLOR
NRLE	31		NR LEVEL
DSPP	43		
SHAD	1	PJ	SHADON
VMSW	1	PJ	RS HAD
SCUT	16	PJ	SHAD CUT OFF

4. METHOD OF CANCELLATION FROM SERVICE MODE

Set the standby condition (Press **POWER** button on the commander) in the next place, press **POWER** button again, hereupon it becomes TV mode.

5. METHOD OF WRITE FOR MEMORY

- 1) Set to Service Mode.
- 2) Press **1** (UP) and **4** (DOWN), select an item of adjustments.
- 3) Press **MUTING** button indicate WRITE (RED) on screen.
- 4) Press **ENTER** button to write for memory.

6. MEMORY WRITE CONFIRMATION METHOD

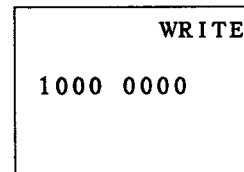

- 1) After adjustment, pull out the plug from AC outlet, and next place, plug in AC outlet again.
- 2) Turn the power switch ON and set to Service Mode.
- 3) Call the adjusted items again, confirm they were adjusted.

5-2. A BOARD ADJUSTMENTS

RF AGC ADJUSTMENT (IF BLOCK VR)

- 1) Input a color-bar signal.
- 2) Adjust AGC VR of TU 101 so that snow noise and cross-modulation disappear from the picture.
- 3) Confirm them at every channel.

H.FREQUENCY ADJUSTMENT (HFRE)

- 1) Set to Service Mode.
- 2) Input a color-bar signal.
- 3) Connect a frequency counter to pin ③ of A-10 connector.
- 4) Call the item of AFC, set to 3 level (free run).
- 5) Select HFRE with **[1]** and **[4]**.
- 6) Adjust **[3]** and **[6]** to the 15735 ± 60 Hz level.
- 7) Call the item of AFC again, adjust the level "01".
- 8) Write into the memory by pressing **[MUTING]** → then **[ENTER]**.

V.FREQUENCY ADJUSTMENT (VFRE)

- 1) Set the Service Mode.
- 2) Input an off-air signal (VIDEO IN → no signal).
- 3) Connect the frequency counter across connector ⑬ pin of E 1-1 connector and ground.
- 4) Select VFRE with **[1]** and **[4]**.
- 5) Adjust **[3]** and **[6]** to the 56 ± 0.5 Hz.
- 6) Write the memory by pressing **[MUTING]** → then **[ENTER]**.

SUB CONTRAST ADJUSTMENT (SPIX)

- 1) Set to Service Mode.
- 2) Input a color-bar signal. (75 IRE)
- 3) Set the conditions as follows.

PICTURE	MAX
COLOR	MIN
BRIGHTNESS	MIN
TRINITONE	LOW
R OFF	ON
G OFF	OFF
B OFF	OFF

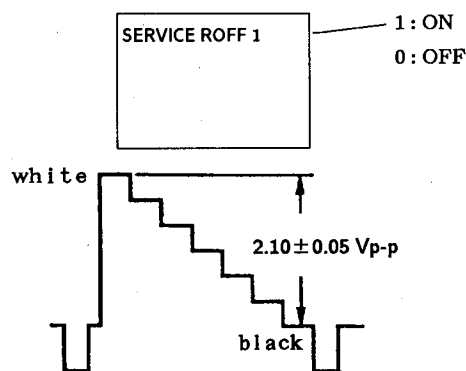

- 4) Connect an oscilloscope to ⑳ pin of E1-1 connector on A board and ground.
- 5) Adjust **[3]** and **[6]** to the 2.10 ± 0.05 Vp-p level by select-ing SPIX with **[1]** and **[4]**.
- 6) Write the memory by pressing **[MUTING]** → then **[ENTER]**.
- 7) Return the following back to normal after adjustment.

G OFF	ON
B OFF	ON
COLOR	CENTER
BRIGHTNESS	CENTER
TRINITONE	HIGH
PICTURE	80%

SUB HUE, SUB COLOR ADJUSTMENT (SHUE, SCOL)

- 1) Input a color-bar signal.
- 2) Press **STANDARD** to normal.
- 3) Set to Service Mode.
- 4) Connect an oscilloscope to pin ② of E1-1 connector on A board and ground.
- 5) Adjust ③ and ④ to the $V1=V4$ and $V2=V3$ by select to SHUE and SCOL with ① and ④. Lower the data 4 steps from this point.

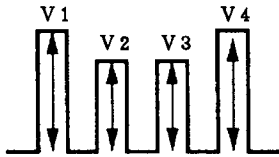

- 4) Make the data "00" by selecting FILO with ① and ④. And then, send up the data gradually by pressing ⑥. Set the data to D1 before SAT3 changing to 1 from 0.
- 5) Send up the data gradually. Set data D2 when SAT3 changes 0 from 1.
- 6) Adjust the data of FILO to $\frac{D1 + D2}{2}$.
- 7) Write into the memory by pressing **MUTING** → then **ENTER**.

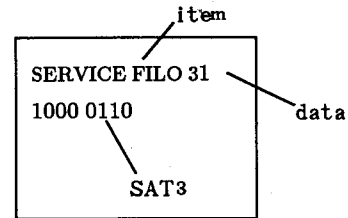

- 6) Write into the memory by pressing **MUTING** → then **ENTER**.

FILTER ADJUSTMENT (MPX, FILO)

- 1) Set to Service Mode.
- 2) Select to **TEST** with ① and ④, set the data to "1". Then select MPX and change data to "8".
- 3) Connect an audio oscillator to R224 using a capacitor (10μF/16V), set frequency to 62.936 kHz ± 0.1 kHz.

And then, through the 10kΩ resistor, feed 9.0V into the mute of TUVIF TU 101.

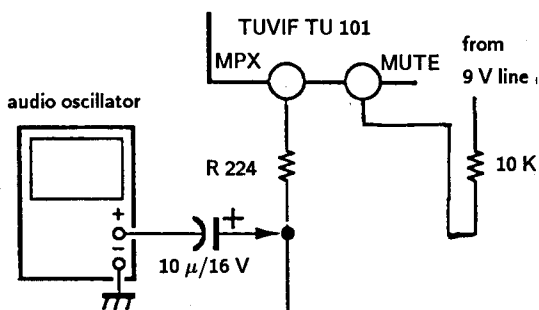

V4 fh : SINE-WAVE 62.936 KHz ± 0.1 KHz
LEVEL 3.0 Vp-p

ST VCO ADJUSTMENT (MPX, STEV)

- 1) Set to Service Mode.
- 2) Select **TEST** with ① and ④, set the data to "1". And then press **MTS** to MONO.
- 3) Select MPX, set the data "8".
- 4) Connect an audio oscillator to R224 using electrolytic capacitor (10μF/16V) and apply the frequency Vst. Then, apply DC voltage to mute of TUVIF TU 101 using 10kΩ connect to 9.0 V line.

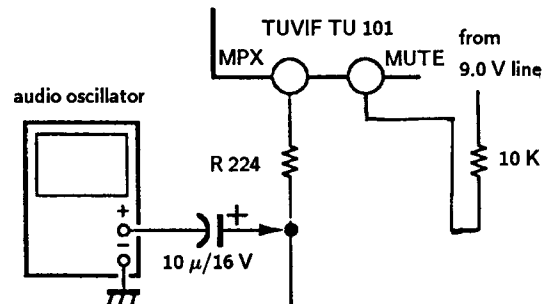

Vfh : SINE-WAVE 15.734 KHz ± 0.1 KHz
LEVEL 0.28 Vp-p

- 5) Select STEV with **1** and **4**, set the data to "00" with **6**. And then, send up the data gradually. Set the data to D1 before SAT2 changes from 0 to 1.
- 6) Send up data gradually, set the data to D2 when SAT2 changes 1 from 0.
- 7) Adjust the data of STEV to $(D1 + D2) / 2$.
- 8) Write into the memory by pressing **MUTING** → then **ENTER**.

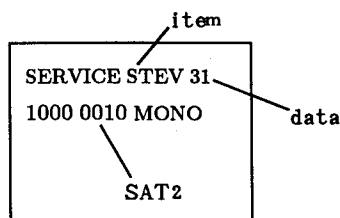

SEPARATION ADJUSTMENT (SEP)

- 1) Set to Service Mode.
- 2) Press **MTS** to MAIN and receive a monoral broadcast signal.

In the next step, receive a stereo broadcast signal.

- 3) Select SEP and VD with **1** and **4**, adjust **3** and **6** so that a clear stereo sound is effected.

MPX IN LEVEL ADJUSTMENT (MPX)

- 1) Set to Service Mode.
- 2) Select TEST with **1** and **4**, set the data to "00" with **6**. And then press **MTS** to MONO.
- 3) Select MPX with **1** and **4**, set the data to "8" with **3** and **6**.
- 4) Write into the memory by pressing **MUTING** → then **ENTER**.

PILOT CANCEL ADJUSTMENT (PILO)

- 1) Set to the Service Mode.
- 2) Select PILO with **1** and **4**, set the data to "8" with **3** and **6**.
- 3) Write into the memory by pressing **MUTING** → then **ENTER**.

SAP VCO f₀ ADJUSTMENT (SAPV)

- 1) Set to Service Mode.
- 2) Input a stereo broadcast signal with SAP.
- 3) Select TEST with **1** and **4**, set the data to "0" . And then, press **MTS** to MAIN.
- 4) Connect a digital multimeter to TP-1(DBX). This voltage reading will equal V 1.
- 5) Press MTS to SAP and this voltage will equal V 2.
- 6) Select SAPV with **1** and **4**, adjust **3** and **6** so that $V2 = V1 \pm 0.03$ VDC.
- 7) Write the memory by **MUTING** → **ENTER**.

5-3. DS BOARD ADJUSTMENTS

V. 3 WAVE ADJUSTMENT (RV983)

- 1) Input a color-bar signal.
- 2) Connect an oscilloscope IC1712 Pin⑦ of DS board ground.
- 3) Adjust RV983 as shown the following figure.

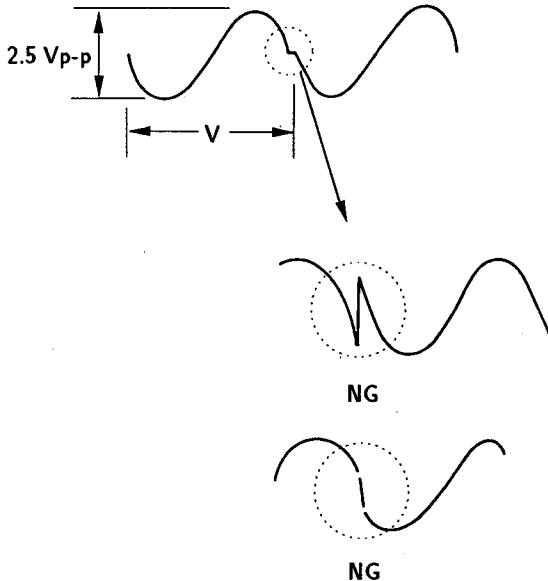

H. 3 WAVE ADJUSTMENT (RV984)

- 1) Input a color-bar signal.
- 2) Connect an oscilloscope IC1712 Pin① of DS board ground.
- 3) Adjust RV984 as shown the following figure.

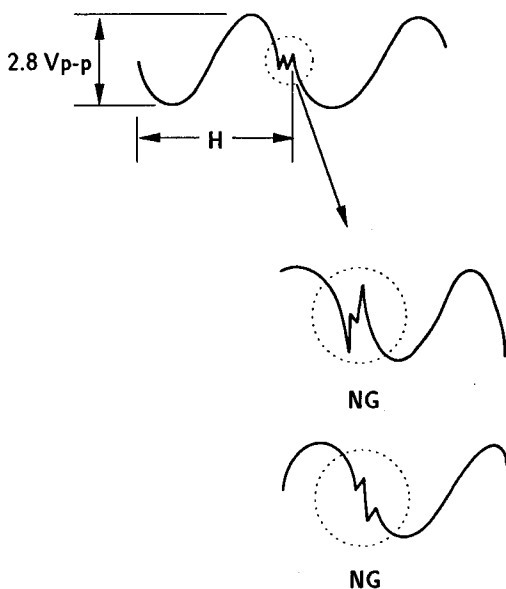

5-4. P2 BOARD ADJUSTMENTS

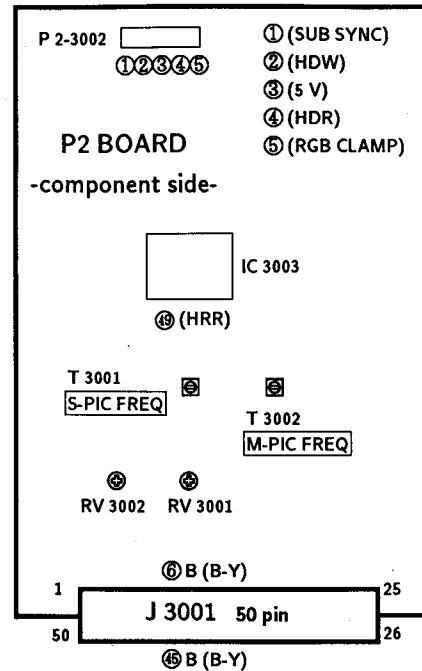

MAIN-PICTURE FREQUENCY (T 3002)

- 1) Set PIP mode.
- 2) Connect a frequency counter to Pin 11 (HDW) of J 3001.
- 3) Connect a frequency counter to Pin ④ or ⑤ (HRR) of IC 3003 or Pin 5 (RGB CLAMP) of P 2-3002.
- 4) Short the circuit between Pin 4 (HDR) of P 2-3002 and Pin 3 (5 V) of P 2-3002.
- 5) Turn T 3002 CLK (P) for the following frequency at Pin ④ or ⑤ (HRR) of IC 3003 or at Pin 5 (RGB CLAMP) of P 2-3002.

15.734 kHz ± 10 Hz

SUB-PICTURE FREQUENCY (T 3001)

- 1) Set PIP mode.
- 2) Connect a frequency counter to Pin 11 (HDW) of J 3001.
- 3) Connect a frequency counter to Pin ④ or ⑤ (HRR) of IC 3003 or Pin 5 (RGB CLAMP) of P 2-3002.
- 4) Short the circuit between Pin 1 (SUB SYNC) of P 2-3002 and Pin 3 (5 V) of P 2-3002.
- 5) Turn T 3001 CLK (C) for the following frequency at Pin 2 (HDW) of P 2-3002.

15.734 kHz ± 10 Hz

5-5. P3 BOARD ADJUSTMENTS

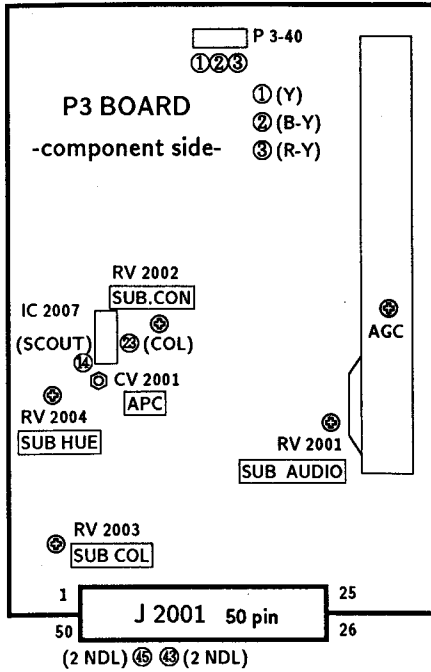

RF AGC ADJUSTMENT (IF BLOCK VR)

- 1) Input a color-bar signal.
- 2) Set to PICTURE IN PICTURE mode.
- 3) Adjust AGC VR of TU 2001 so that snow noise and cross-modulation disappear from the picture.
- 4) Confirm them at every channel.

SUB PICTURE SOUND VOLUME LEVEL (SUB AUDIO) ADJUSTMENT (RV2001)

- 1) Receive an audio signal of 400 Hz. (100% mod.)
- 2) Adjust RV 2001 for the following level at Pin 43 (2 NDR) or Pin 45 (2 NDL) of J 2001.

500 mVrms \pm 2 dB

SUB CONT ADJUSTMENT (RV2002)

- 1) Obtain the color bar signal on the sub-screen.
 - 2) Observe at Pin 1 (Y OUT) of P3-42 on an oscilloscope.
- Adjust RV2002 for the following level between the white level and pedestal one.

0.65 ± 0.05 Vp-p

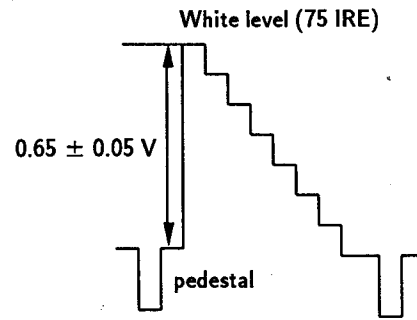

SUB COLOR ADJUSTMENT (RV 2003)

- 1) Obtain the color bar signal on the sub-screen in the mode of PIP size 1/4.
- 2) Reset color.
- 3) Adjust RV 2003 for the following level, observing an oscilloscope connected to Pin 2 (B-Y) of P3-40 (Fig. 1)

0.8 ± 0.05 Vp-p (B-Y)

- 4) Adjust RV 2003 for the following level, observing an oscilloscope connected to Pin 3 (R-Y) of P3-40 (Fig. 2)

0.75 ± 0.1 Vp-p (R-Y)

- 5) Adjust tracking between sub color and sub hue.

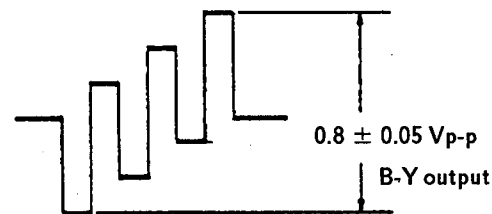

(Fig. 1)

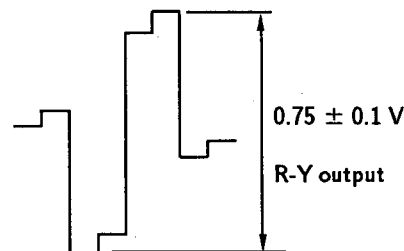

(Fig. 2)

SUB HUE ADJUSTMENT(RV 2004)

- 1) Obtain the color bar signal on the sub-screen in the mode of PIP size 1/4.
- 2) Reset hue.
- 3) Observe the signal at Pin 6 or Pin 45 of J 3001 on P 2 board on an oscilloscope and make adjustment to obtain the following level.

D : $X \pm 20 \text{ mV}$

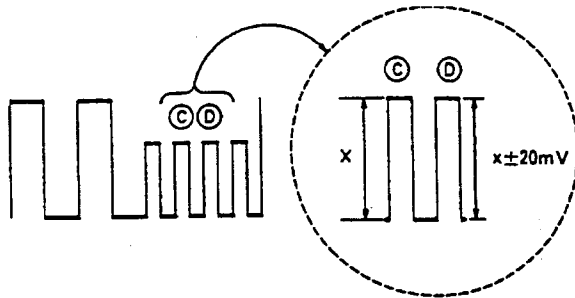

APC ADJUSTMENT(CV 2001)

Connect Pin ⑮ (COL) of IC 2007 to ground and connect a frequency counter to Pin ⑭ (SCOUT) to obtain the following level.

$3579545 \pm 40 \text{ Hz}$

A Board

IC		DIODE	
IC201	D-5	D201	G-4
IC204	D-6	D202	G-4
IC205	E-1	D203	G-9
IC206	B-6	D204	B-2
IC207	A-2	D205	E-4
IC506	G-9	D206	D-7
IC1401	C-5	D207	D-7
IC1601	F-9	D208	E-7
		D209	B-6
		D211	E-4
		D213	A-6
		D214	A-5
		D215	E-2
		D216	E-1
		D217	E-1
		D219	G-5
		D220	E-5
		D221	B-1
		D222	D-6
		D223	D-6
		D501	C-7
		D502	C-7
		D503	B-9
		D504	C-7
		D505	F-7
		D506	F-7
		D507	B-8
		D509	C-7
		D510	A-1
		D511	A-2
		D512	C-9
		D513	D-7
		D514	G-7
		D515	G-8
		D1401	A-3
		D1402	B-4
		D1403	C-7
		D1404	A-3
		D1405	A-3
		D1406	B-5
		D1407	A-4
		D1408	B-5
		D1409	A-4
		D1607	G-10
		D1608	G-10
TRANSISTOR			
Q201	C-4		
Q202	G-3		
Q203	G-9		
Q501	C-9		
Q502	B-9		
Q504	G-7		
Q505	C-9		
Q506	C-9		
Q507	D-10		
Q508	B-10		
Q509	G-8		
Q510	C-8		
Q511	A-2		
Q512	A-2		
Q1401	B-4		
Q1402	C-7		
Q1407	B-5		
Q1408	B-4		
Q1601	E-9		
Q1602	E-10		
Q1603	E-10		
Q1604	E-10		
Q1605	E-9		
Q1606	E-9		
Q1620	D-8		

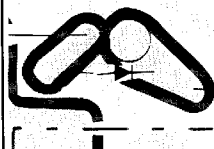

NOTE:

The circuit indicated as left contains high voltage of over 600 Vp-p. Care must be paid to prevent an electric shock in inspection or repairing.

E1 [Y/C JUNGLE]

- E1 Board -
<Component Side>

E1 Board

IC	
IC301	C-5
IC302	B-4, G-4
IC303	C-3

TRANSISTOR	
Q301	C-2
Q302	C-1
Q303	G-1
Q304	A-2
Q305	B-1
Q306	H-3
Q307	C-2
Q309	F-2
Q310	D-2
Q311	B-2
Q312	B-2
Q314	B-2
Q315	G-5
Q316	G-5
Q317	E-3
Q321	D-2
Q322	G-4
Q323	F-3
Q324	G-3
Q325	G-3
Q326	D-5
Q327	G-3
Q328	F-5
Q329	C-3
Q330	C-3
Q333	D-4
Q334	D-4
Q335	D-4
Q340	E-4
Q342	D-5
Q344	D-3

DIODE	
D301	F-1
D302	G-1
D303	G-1
D304	B-3
D305	F-3
D306	C-4
D307	G-4
D310	G-4
D312	G-4
D313	G-3
D314	G-3
D315	G-2
D316	G-3
D317	B-5
D318	F-5
D319	B-5
D320	G-5
D321	B-2

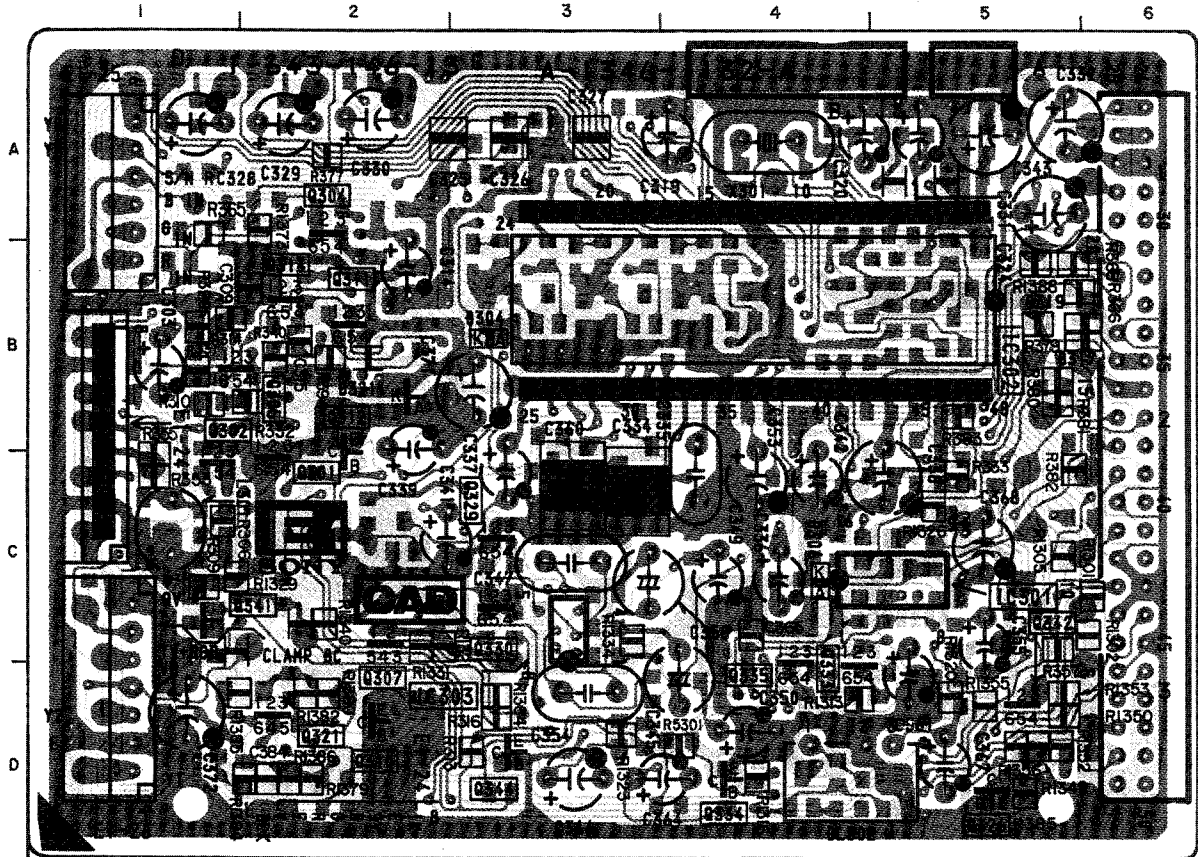

<Conductor Side>

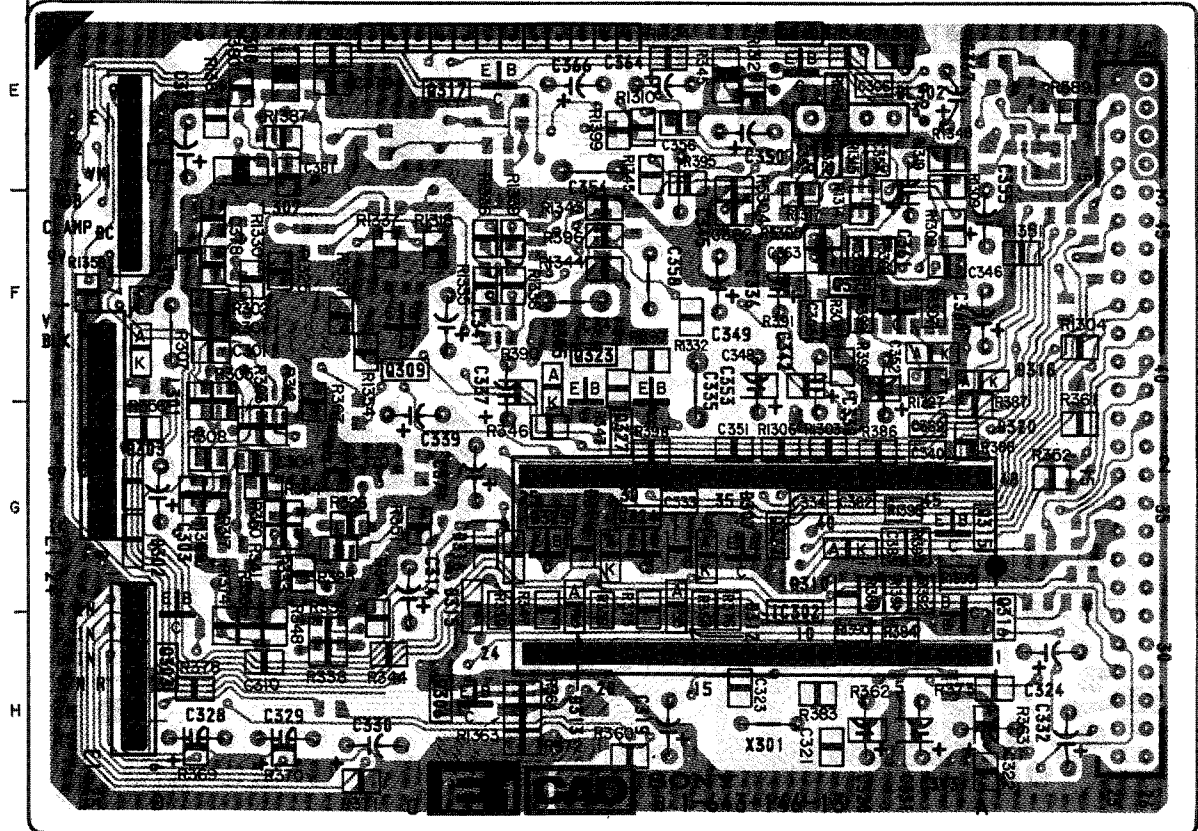

• [Pattern from the side which enables seeing]
• [Pattern of the rear side]

E2 SHARPNESS CONT.
CHARACTOR GENERATER

- E2 Board -
<Component Side>

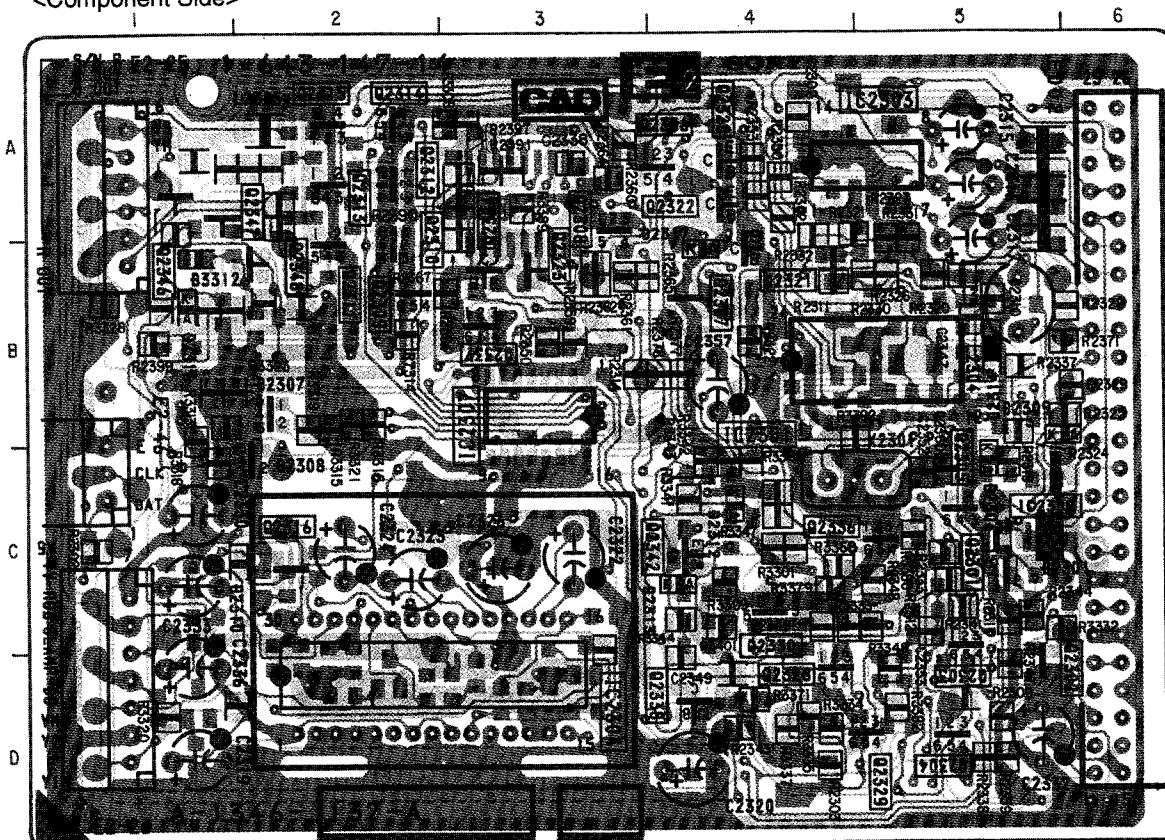

<Conductor Side>

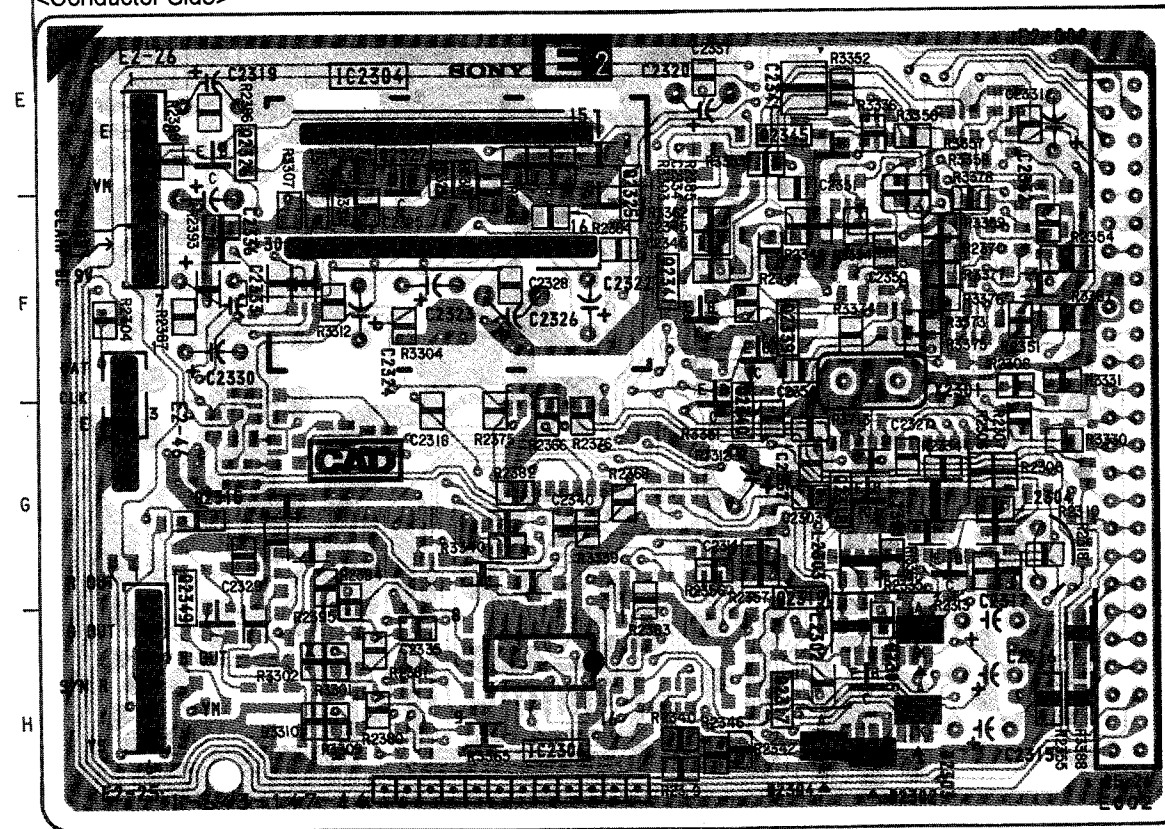

E2 Board

IC	
IC2301	B-4
IC2303	A-5
IC2304	D-3, E-2
IC2306	H-3
IC2307	B-3
TRANSISTOR	
Q2301	C-5
Q2303	C-5
Q2304	D-5
Q2305	C-5
Q2306	A-3
Q2307	B-4
Q2308	A-3
Q2309	B-2
Q2310	A-2
Q2311	A-2
Q2312	A-2
Q2313	A-2
Q2314	A-2
Q2315	A-2
Q2317	H-4
Q2318	G-4
Q2319	G-5
Q2320	A-4
Q2321	A-4
Q2322	A-4
Q2324	B-3
Q2326	E-1
Q2327	E-2
Q2330	C-4
Q2337	B-3
Q2338	D-4
Q2339	F-4
Q2340	F-4
Q2341	F-4
Q2342	C-4
Q2345	E-4
DIODE	
D2306	C-5
D2307	B-2
D2308	B-2
D2309	B-5
D2312	C-4
D2313	C-4
D2314	B-5
D2317	A-4

• : Pattern from the side which enables seeing.
• : Pattern of the rear side.

Y2

MTS DECORDER,
NVM,
AUDIO CONT.

- Y2 Board -
<Component Side>

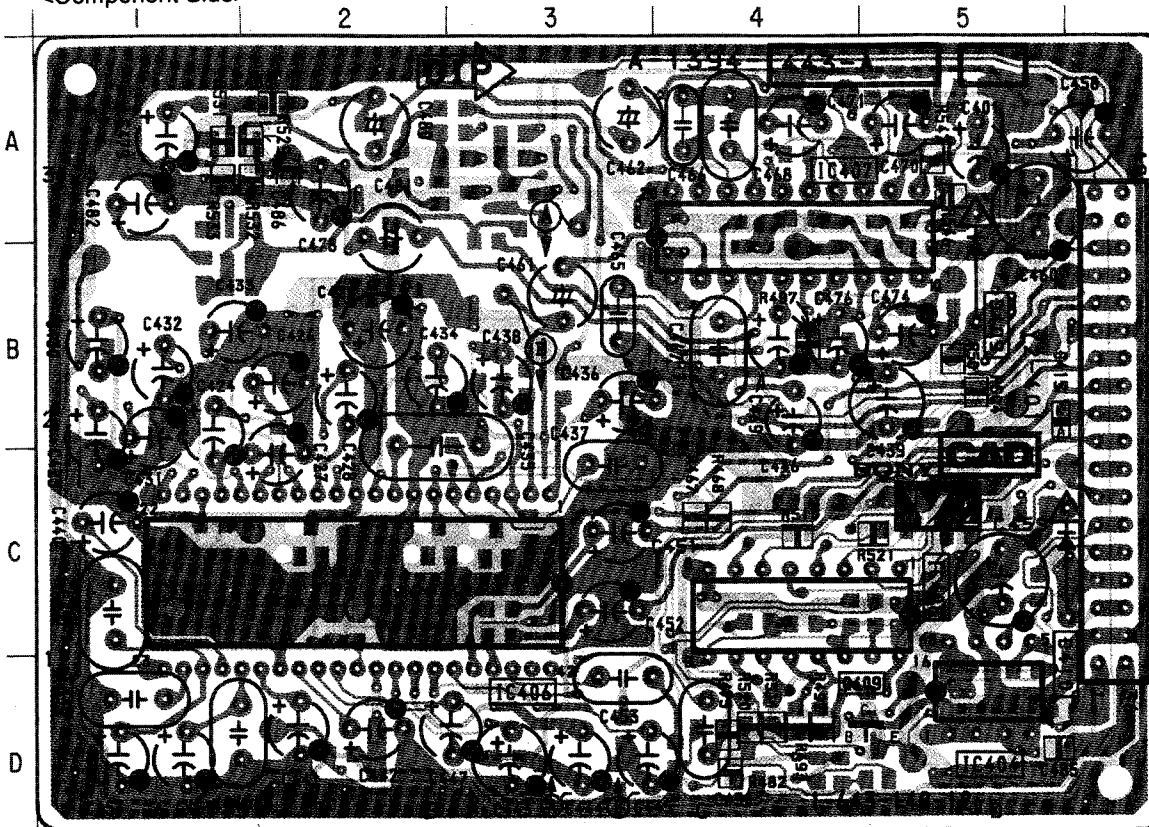

Y2 Board

IC	
IC403	H-1
IC404	D-5, E-5
IC406	C-2, F-2
IC407	A-4, G-4
IC408	C-4, F-4
TRANSISTOR	
Q404	H-3
Q405	H-3
Q409	D-5
Q410	E-5
DIODE	
D405	F-2
D406	F-2
D407	F-3
D408	E-4
D409	A-5
D410	C-5, F-5
D413	E-6
D414	F-4
D415	B-5

<Conductor Side>

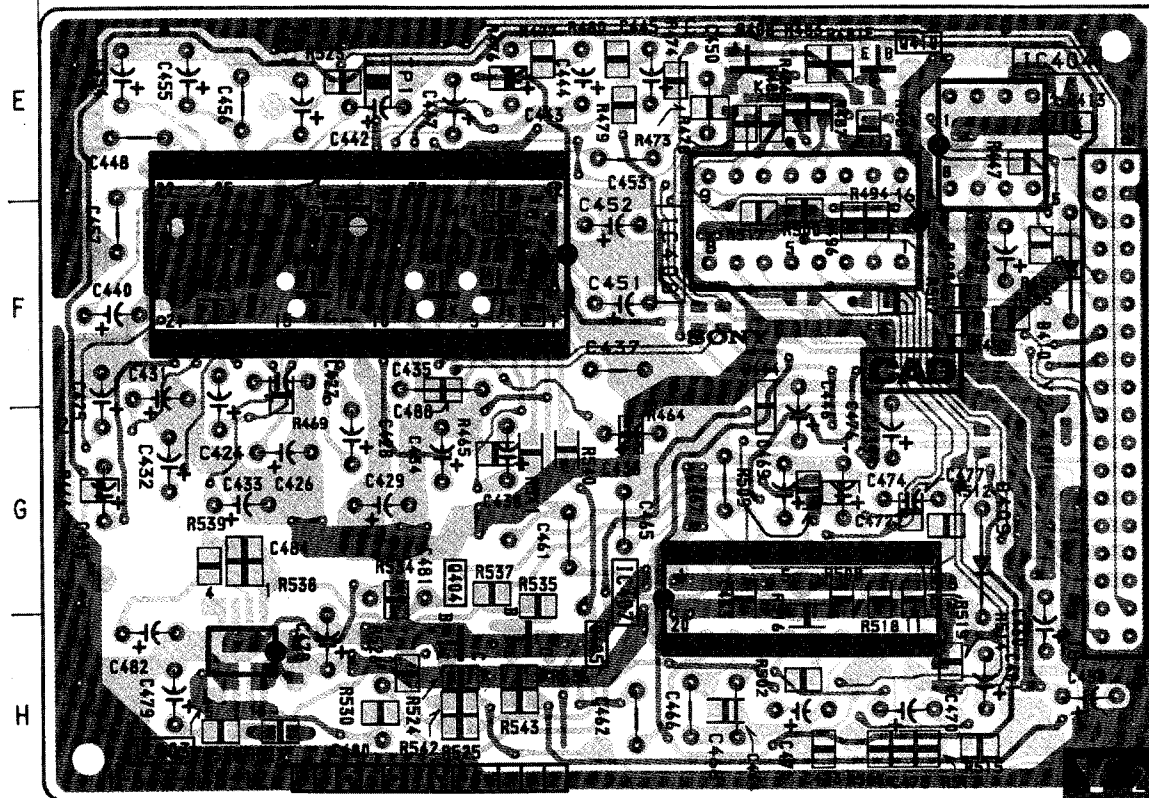

- : Pattern from the side which enables seeing.
- : Pattern of the rear side.

Schematic diagram

Schematic diagram

P4 [DIGITAL COMB FILTER]

— P4 Board —
<Component Side>

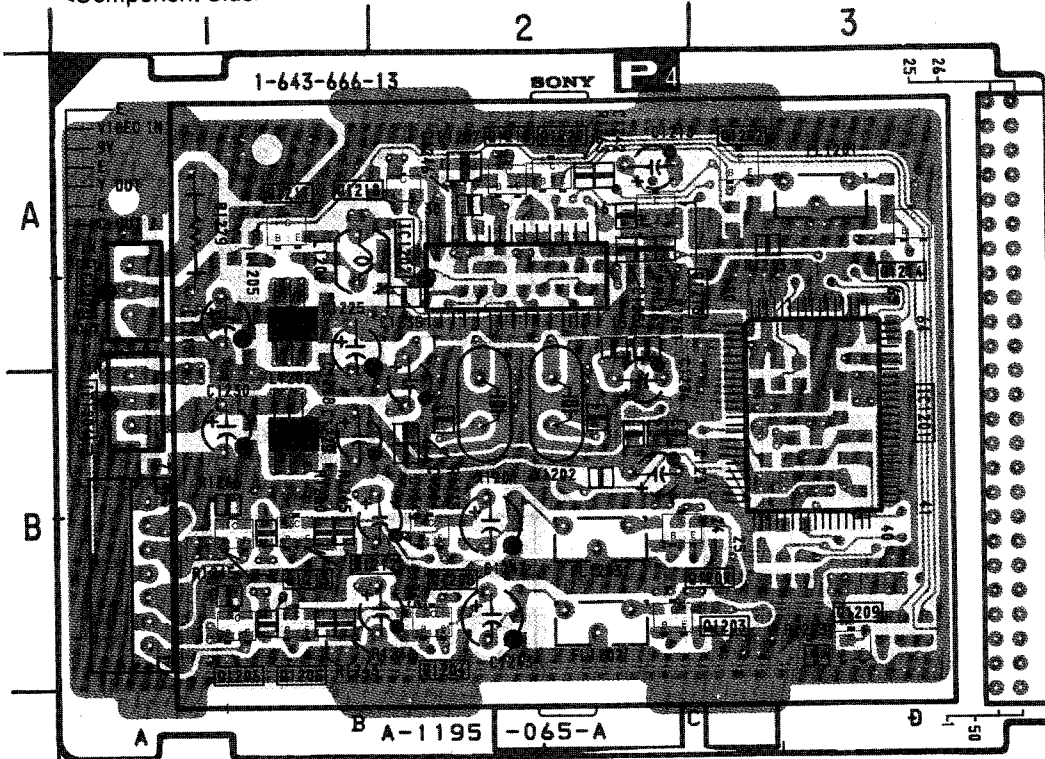

C <Conductor Side>

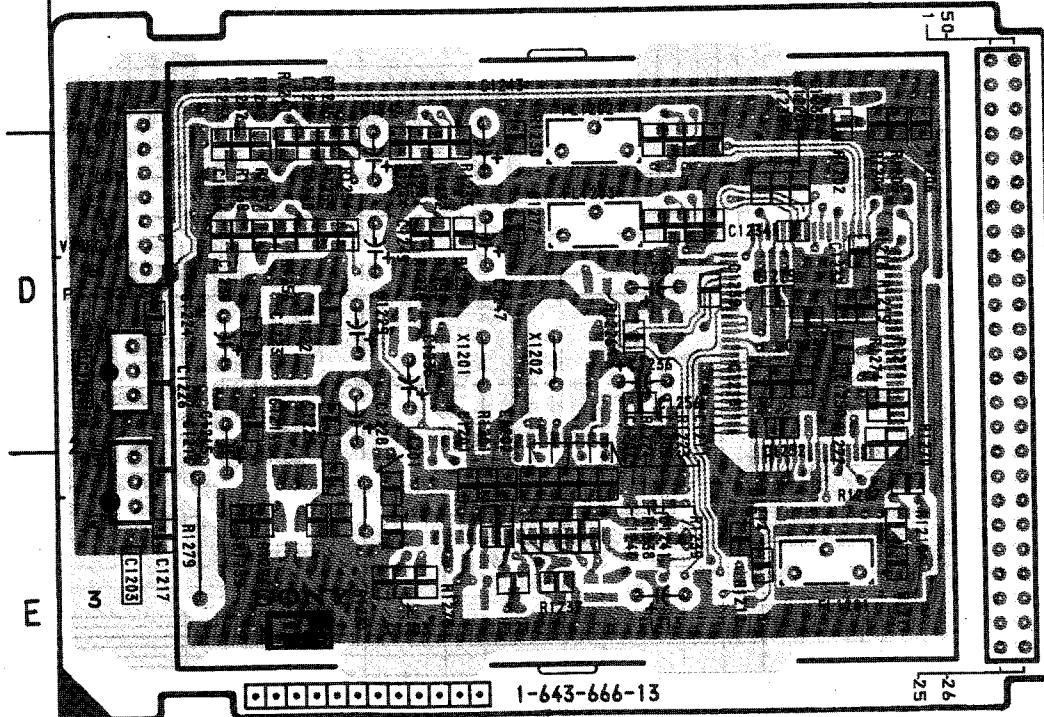

P4 Board

IC	
IC1201	B-3
IC1202	A-2
IC1203	A-1, E-1
IC1204	B-1, D-1
TRANSISTOR	
Q1202	A-3
Q1203	B-2
Q1204	B-2
Q1205	B-1
Q1206	B-1
Q1207	B-2
Q1208	B-2
Q1209	B-3
Q1211	A-1
Q1212	B-1
Q1213	A-2
Q1214	A-3
Q1215	B-1
Q1218	A-2
Q1220	A-2
CRYSTAL	
X1201	B-2, D-2
X1202	B-2, D-2

- : Pattern from the side which enables seeing.
- : Pattern of the rear side.

YG [POWER RECT]

- YG Board -

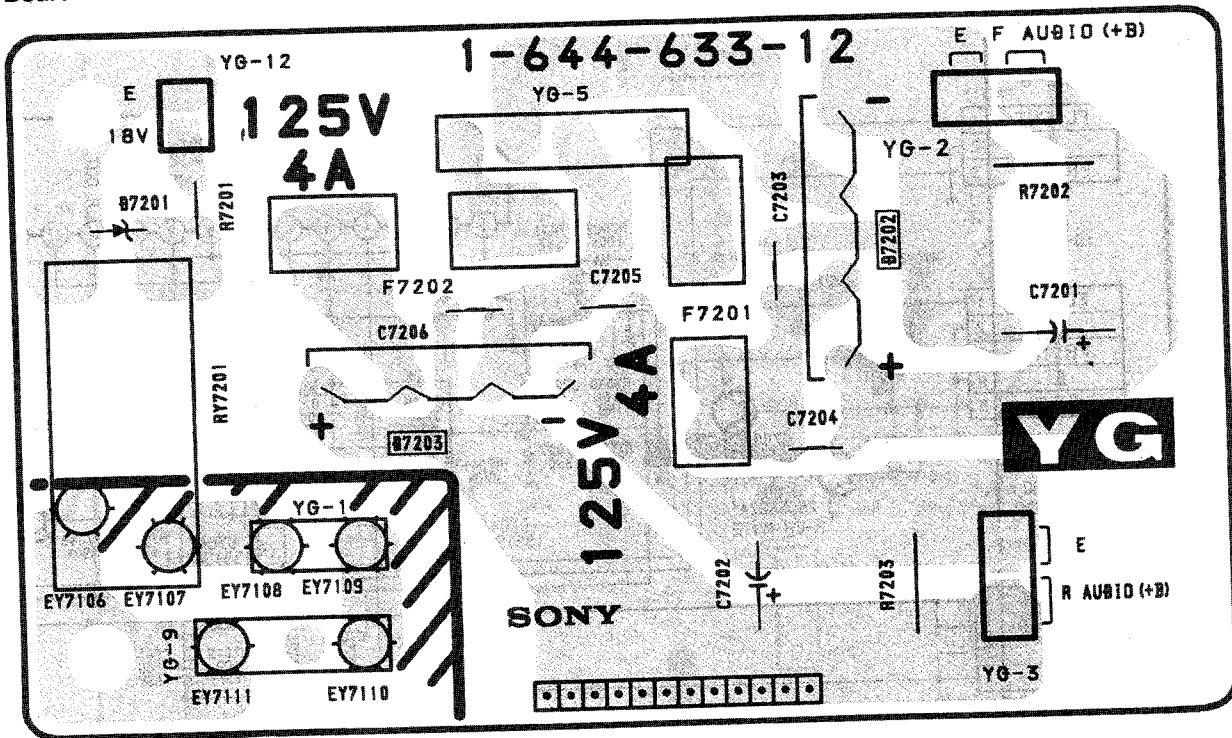

P2

[MPX PICTURE IN PICTURE CIRCUIT]

- P2 Board -
<Component Side>

<Conductor Side>

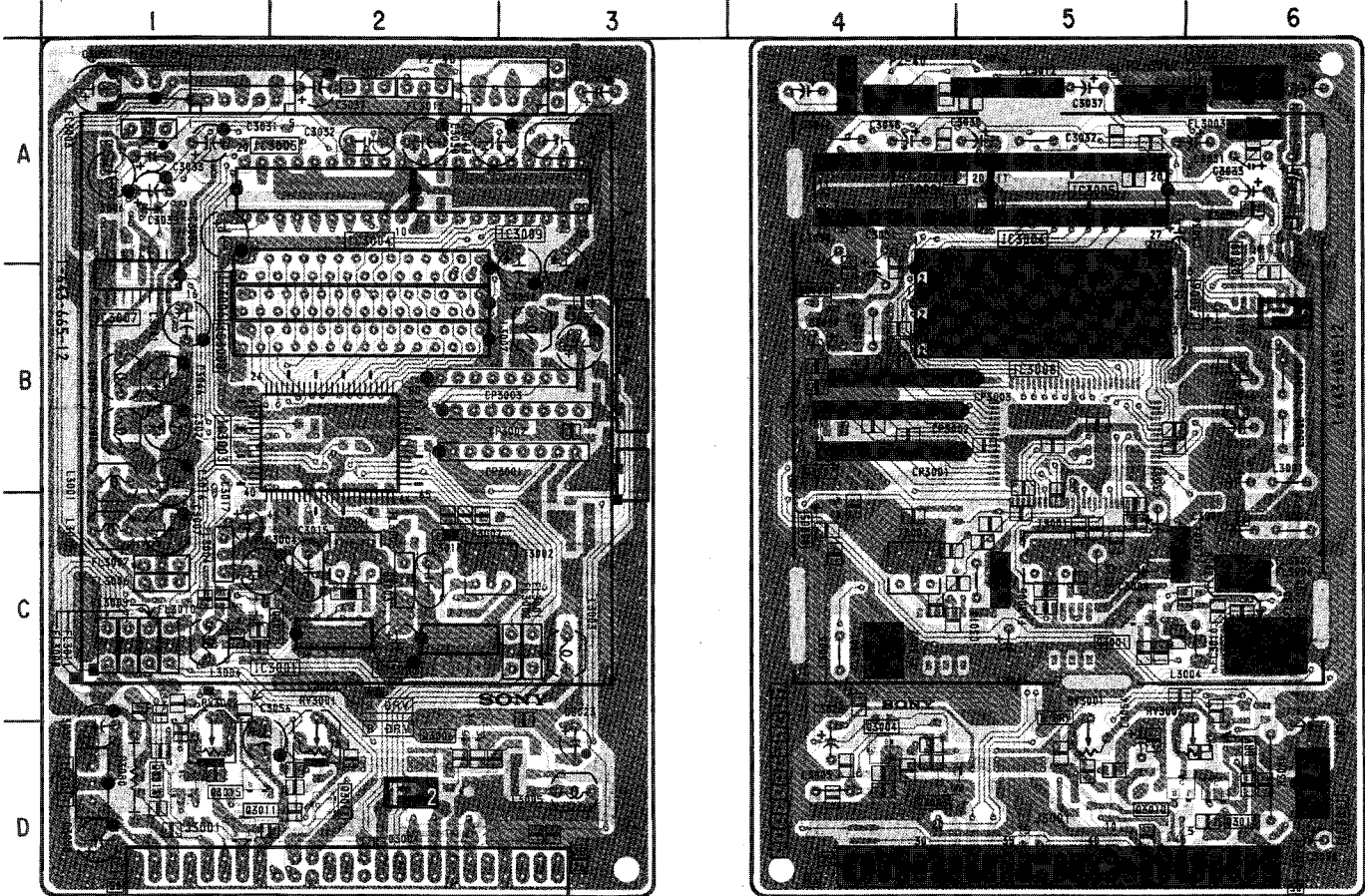

P2 Board

IC	TRANSISTOR	DIODE
IC3001 C-2	Q3001 C-5	D3002 C-2
IC3002 C-2	Q3002 C-2	D3003 C-2
IC3003 B-2	Q3003 D-4	D3004 D-2
IC3004 A-2, B-5	Q3004 D-4	
IC3005 A-2, A-5	Q3005 C-4	
IC3006 B-2, B-5	Q3006 D-2	
IC3007 B-1	Q3007 B-4	VARIABLE RESISTOR
IC3008 B-2, B-5	Q3008 B-4	
IC3009 A-2, A-4	Q3009 B-6	RV3001 D-2, D-5
IC3010 A-1, A-6	Q3010 D-5	RV3002 D-1, D-5
IC3011 D-1, D-6	Q3011 D-1	
	Q3012 D-2	
	Q3013 D-6	
	Q3014 D-1	
	Q3015 D-1	

- [Pattern] : Pattern from the side which enables seeing.
- [Pattern] : Pattern of the rear side.

CB [B OUT] **ZB** [DY I/F]

— CB Board —

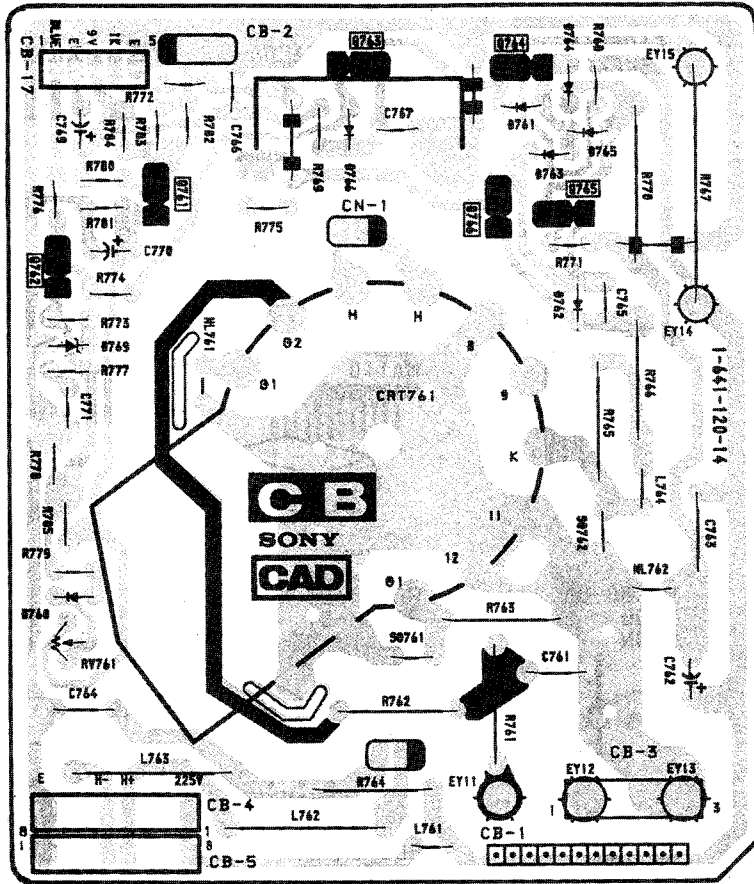

— ZB Board —

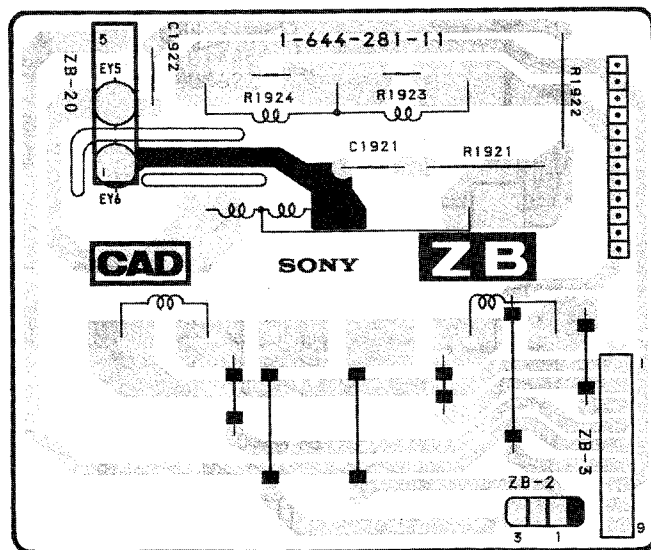

CG [G OUT] **ZG** [DY I/F]

— CG Board —

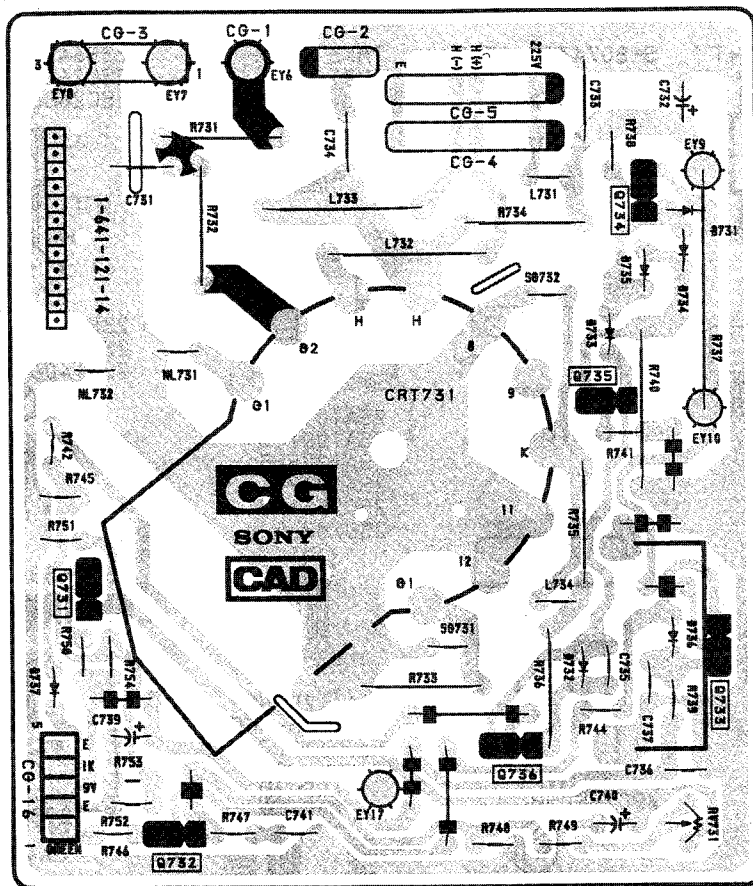

— ZG Board —

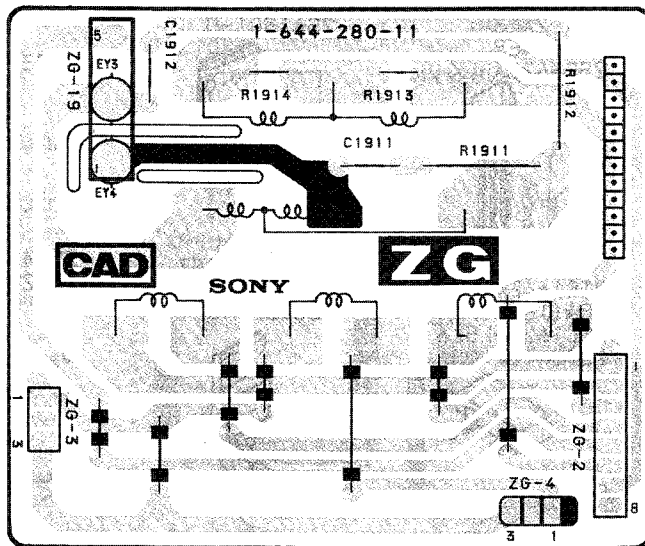

CR [R OUT] **ZR** [DY. I/F]

- CR Board -

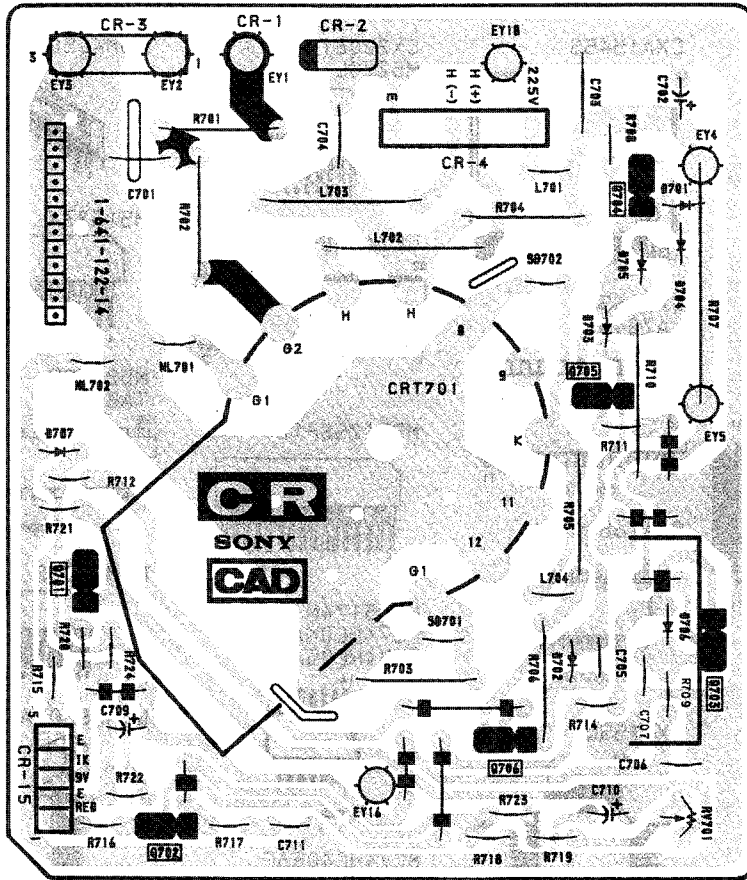

- ZR Board -

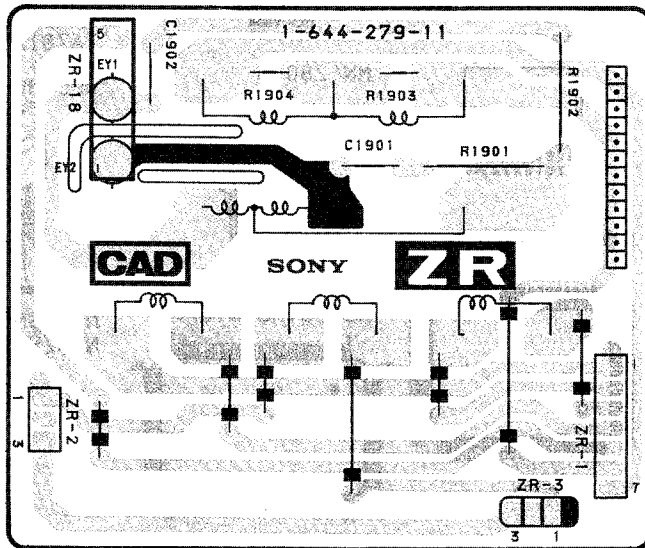

6-7. SEMICONDUCTORS

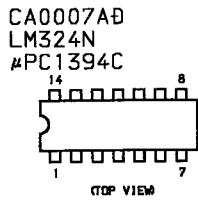

CXØ1160AQ
CXØ1220AQ
CXØ2023Q
CXØ2704Q
TMC73C247-10

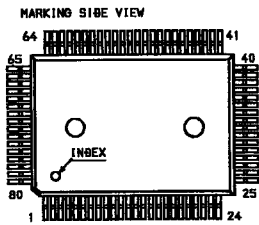

CXA1228S
CXA1268P

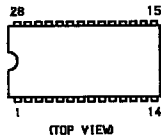

CXA1264AS
PA0036

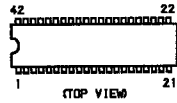

CXA1315M
CXA1315P
MC141053CP
#PØ4053BC

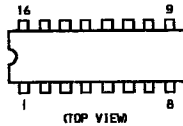

CXA1387S

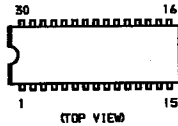

CXA1464AS

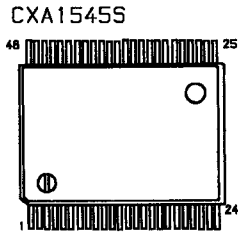
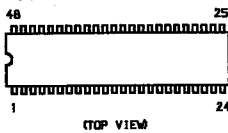

CXA1656S
LA7945

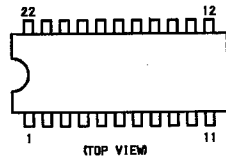

CXA1686M

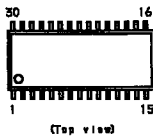

CXØ255Q

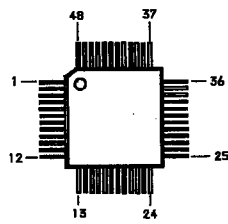

CXK1006L

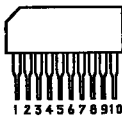

CXP5068H-205Q

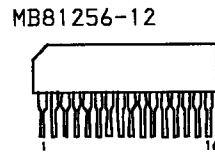
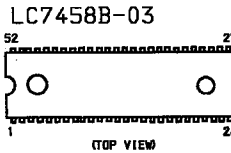
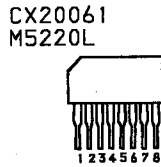
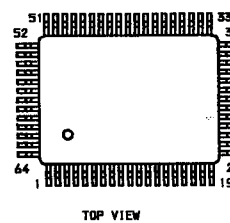

MC33174M
MC74HC04AF
SN74HC05ANS



MC74HC4053F

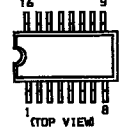

MN1280-5

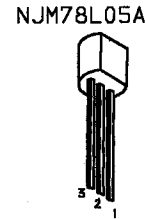
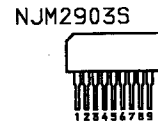
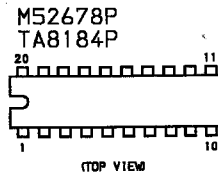
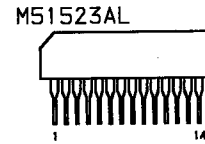
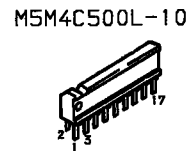
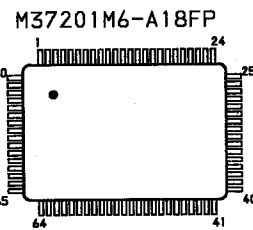

NJM78M05FA
TA7805S
TA7812S
#PC2415HF
#PC7893AH

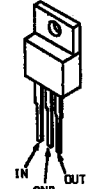

NJM79M05FA
NJM7915FA

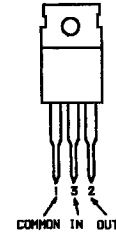

PCA8510T/012-T

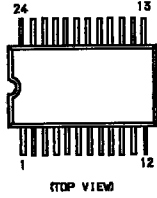

TOP VIEW

RBA-402



RC4558P
TL082CP
μPC393C
μPC4557C
24C04A1/P

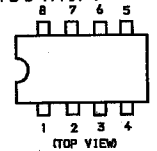

TOP VIEW

RC4558PS
μPC4558G2

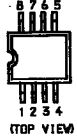

TOP VIEW

SI-3090CA

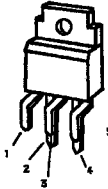

STK-4278L

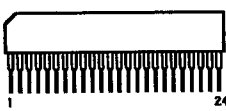

STK4412

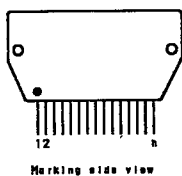

Marking side view

S-80743AL-A7-S

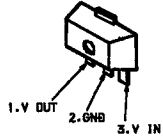

TAB200AH
TAB216H

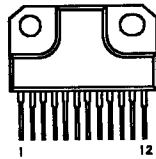

μPC1498H

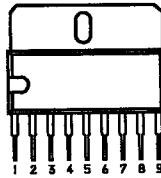

μPC78N05H



DTA124ES
DTC144ES
2SC3622A-LK

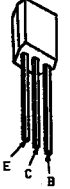

DTC144EK
2SA1162-G
2SC1623-L5L6
2SC2412K-QR

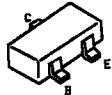

FMW1



IMX3
IMZ1



XN4401

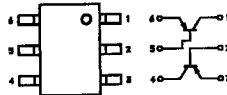

2SA1013-0
2SA1091-0
2SA1208-S
2SA1837
2SC2551-0
2SD788-5



2SA1175-HFE
2SC2785-HFE

Letter side

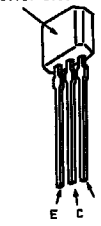

2SA1301-0



2SB4632-CB7
2SC4891-CA
2SD1887-CA

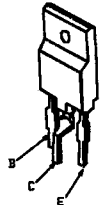

2SB649A-C
2SC2611
2SC2688-LK

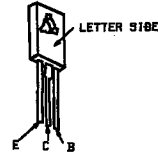

2SB861-C
2SB1094-LK
2SD1406-YGR



2SC2555-2



2SC3298B-Y



2SC3733



2SC4582-NP
2SD2012



25D874A-R

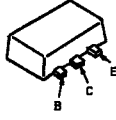

S8K108-C



ØØ50R

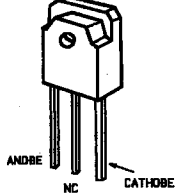

Ø1NS4
EGP10Ø
RB-100A
RØ13ES-B2
RØ18ES-B2
RØ2.0ES-B1
RØ24ES-B3
RØ3.3ES-B2
RØ3.9ES-B1
RØ33ES-B2
RØ39ES-B2
RØ4.7ES-B2
RØ5.1ES-B1
RØ5.1ES-B2
RØ5.6ES-B2
RØ7.5ES-B1
RØ9.1ES-L
1SS119
1SS198TA

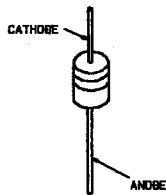

Ø10SC6M
Ø5KC40H



Ø10SC6MR

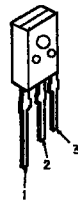

ERC38-06
V09G
V30N

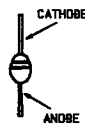

ERC06-15S
RU-1C

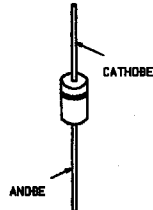

FMN1

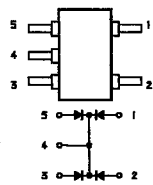

GP08Ø
ERØ28-Ø8S
RØ27FB2
SB140

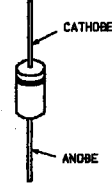

MA110
MA3130

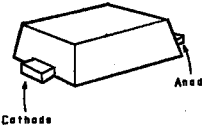

RØ15M-B1
RØ18M-B1
RØ5.1M-B3

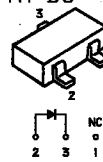

RØ3.3M-B1
RØ5.6S-B
RØ6.2S-B
RØ6.8M-B1

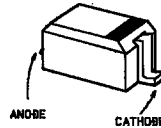

RØ9.1E-W



S1VB40

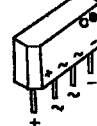

S3V10SB

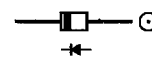

S5VB60

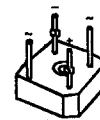

1T33

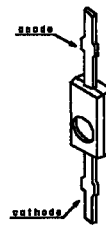

TLR124

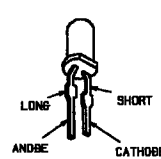

SECTION 7 EXPLODED VIEWS

NOTE:

- Items with no part number and no description are not stocked because they are seldom required for routine service.
- The construction parts of an assembled part are indicated with a collation number in the remark column.
- Items marked "★" are not stocked since they are seldom required for routine service. Some delay should be anticipated when ordering these items.

The components identified by shading and mark ▲ are critical for safety. Replace only with part number specified.

Les composants identifiés par une trame et une marque ▲ sont critiques pour la sécurité. Ne les remplacer que par une pièce portant le numéro spécifié.

**7-1-1. SCREEN FRAME AND CONTROL PANEL
(KP-46XBR35/53XBR35 (US/CND))**

- : BVTP3X12 7-685-648-79
- : BVTP4X16 7-685-663-79
- ▲ : BVTP4X12 7-685-661-79
- △ : KTP3X12 7-685-248-14
- : BVTP4X12 7-685-661-14

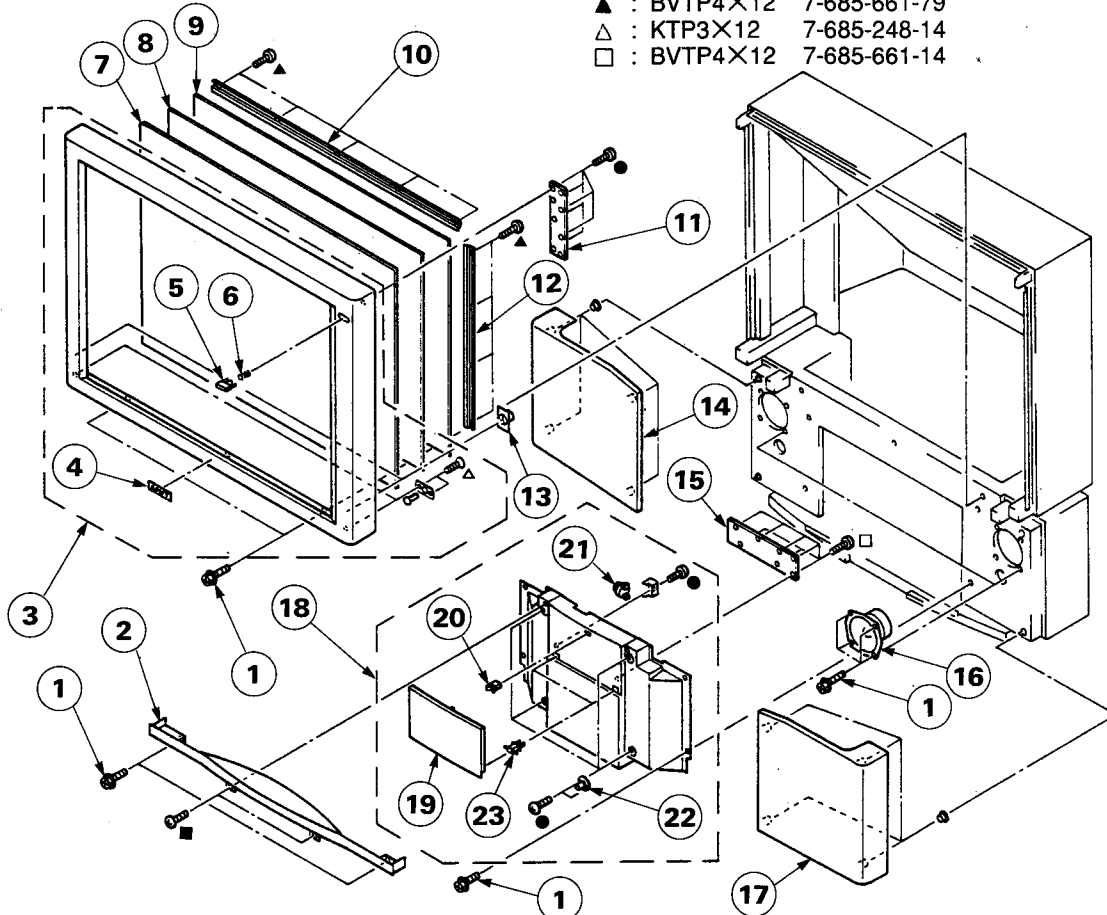

REF. NO.	PART NO.	DESCRIPTION	REMARK	REF. NO.	PART NO.	DESCRIPTION	REMARK
1	4-041-164-11	SCREW (4X20), TAPPING		11	*1-643-591-11	H1 BOARD	
2	4-036-470-01	ESCUTCHEON, FRONT		12	4-043-239-01	HOLDER (S), SCREEN	
3	X-4031-193-1	FRAME ASSY, SCREEN (KP-46XBR35)	4-6	13	1-544-580-21	SPEAKER (2.5CM)	
	X-4031-194-1	FRAME ASSY, SCREEN (KP-53XBR35(U/C))	4-6	14	X-4030-553-1	GRILLE (L) ASSY, SPEAKER	
4	4-381-079-01	EMBLEM (NO.10), SONY			X-4030-570-1	GRILLE (L) ASSY, SPEAKER (KP-46XBR35)	(KP-53XBR35(U/C))
5	4-036-523-01	BUTTON, POWER		15	*1-643-592-11	H2 BOARD	
6	3-566-903-00	SPRING		16	1-504-141-11	SPEAKER (13CM)	
7	4-043-235-01	FILTER (53), SCREEN (KP-53XBR35(U/C))		17	X-4030-552-1	GRILLE (R) ASSY, SPEAKER	
	4-043-238-01	FILTER (46), SCREEN (KP-46XBR35)			X-4030-569-1	GRILLE (R) ASSY, SPEAKER (KP-46XBR35)	(KP-53XBR35(U/C))
8	4-037-360-11	PLATE (L), DIFFUSION (KP-46XBR35)		18	X-4030-554-1	PANEL ASSY, CONTROL (KP-53XBR35(U/C))	
	4-036-466-01	PLATE (L), DIFFUSION (KP-53XBR35(U/C))			X-4030-571-1	PANEL ASSY, CONTROL (KP-46XBR35)	
9	4-037-359-11	PLATE (F), DIFFUSION (KP-46XBR35)		19	4-036-461-01	LID, CONTROL (KP-46XBR35)	
	4-036-469-11	PLATE (F), DIFFUSION (KP-53XBR35(U/C))			4-036-475-01	LID, CONTROL (KP-53XBR35(U/C))	
10	4-043-240-01	HOLDER (L), SCREEN (UNDER) (KP-46XBR35)		20	4-392-036-01	CATCHER, PUSH	
	4-043-240-11	HOLDER (L), SCREEN (UNDER) (KP-53XBR35(U/C))		21	3-721-204-01	DAMPER (KP-53XBR35(U/C))	
	4-043-240-21	HOLDER (L), SCREEN (TOP) (KP-46XBR35)			3-721-204-21	DAMPER (KP-46XBR35)	
	4-043-240-31	HOLDER (L), SCREEN (TOP) (KP-53XBR35(U/C))		22	4-843-806-00	STRIKE	
				23	3-703-035-12	SHAFT, LID	

7-1-2. SCREEN FRAME AND CONTROL PANEL (KP-61XBR38)

● : BVTP3X12 7-685-648-79

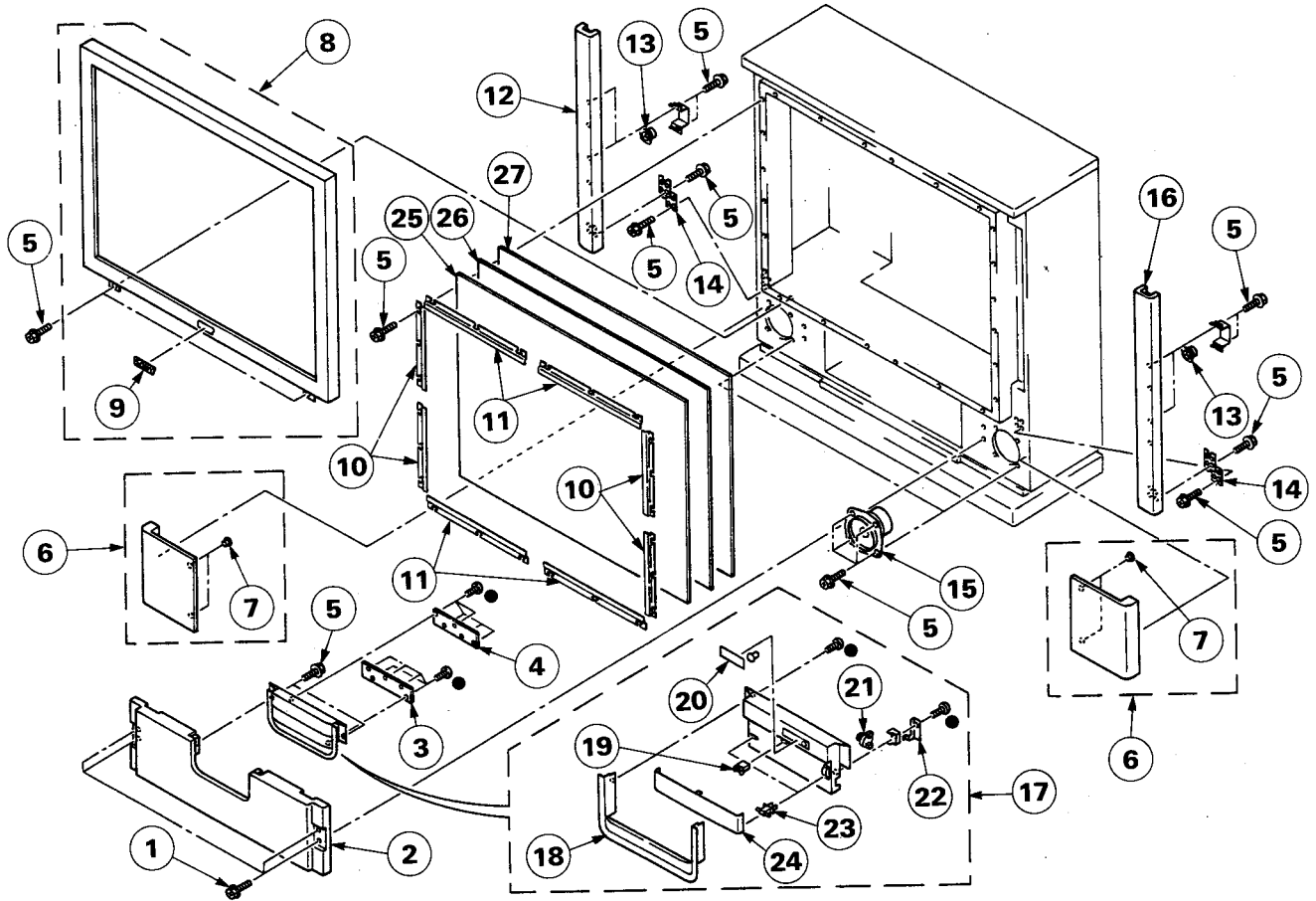

REF. NO.	PART NO.	DESCRIPTION	REMARK	REF. NO.	PART NO.	DESCRIPTION	REMARK
1	4-378-522-21	SCREW, TAPPING, HEXAGON HEAD		16	X-4031-173-1	GRILLE (T/R) ASSY, SPEAKER	
2	X-4031-228-1	PANEL ASSY, FRONT		17	X-4031-179-1	PANEL ASSY, CONTROL	
3	*1-643-592-11	H2 BOARD		18	4-040-584-01	COVER, EDGE	18-24
4	*1-643-591-11	H1 BOARD		19	4-392-036-01	CATCHER, PUSH	
5	4-041-164-11	SCREW (4X20), TAPPING		20	4-036-510-21	PANEL, INDICATOR	
6	X-4031-175-1	GRILLE (B) ASSY, SPEAKER	7	21	3-720-417-01	DAMPER, OIL	
7	4-838-438-00	LATCH		22	4-036-513-01	SPRING, LID	
8	X-4031-177-1	FRAME ASSY, SCREEN	9	23	3-703-035-12	SHAFT, LID	
9	4-381-079-01	EMBLEM (NO.10), SONY		24	4-036-511-21	LID, CONTROL	
10	*4-044-727-01	HOLDER (S), SCREEN		25	4-044-725-11	FILTER, SCREEN	
11	*4-044-726-01	HOLDER (L), SCREEN		26	4-040-124-11	PLATE (L), DIFFUSION	
12	X-4031-174-1	GRILLE (T/L) ASSY, SPEAKER		27	4-040-123-11	PLATE (F), DIFFUSION	
13	1-504-312-11	SPEAKER (SQUAWKER) (5CM)					
14	*4-040-600-01	BRACKET, SPEAKER GRILLE					
15	1-504-313-11	SPEAKER (16CM)					

7-2. CABINET

- : BVTP3X12 7-685-648-79
- : BVTP4X16 7-685-663-79
- ▲ : BVTP4X12 7-685-661-79

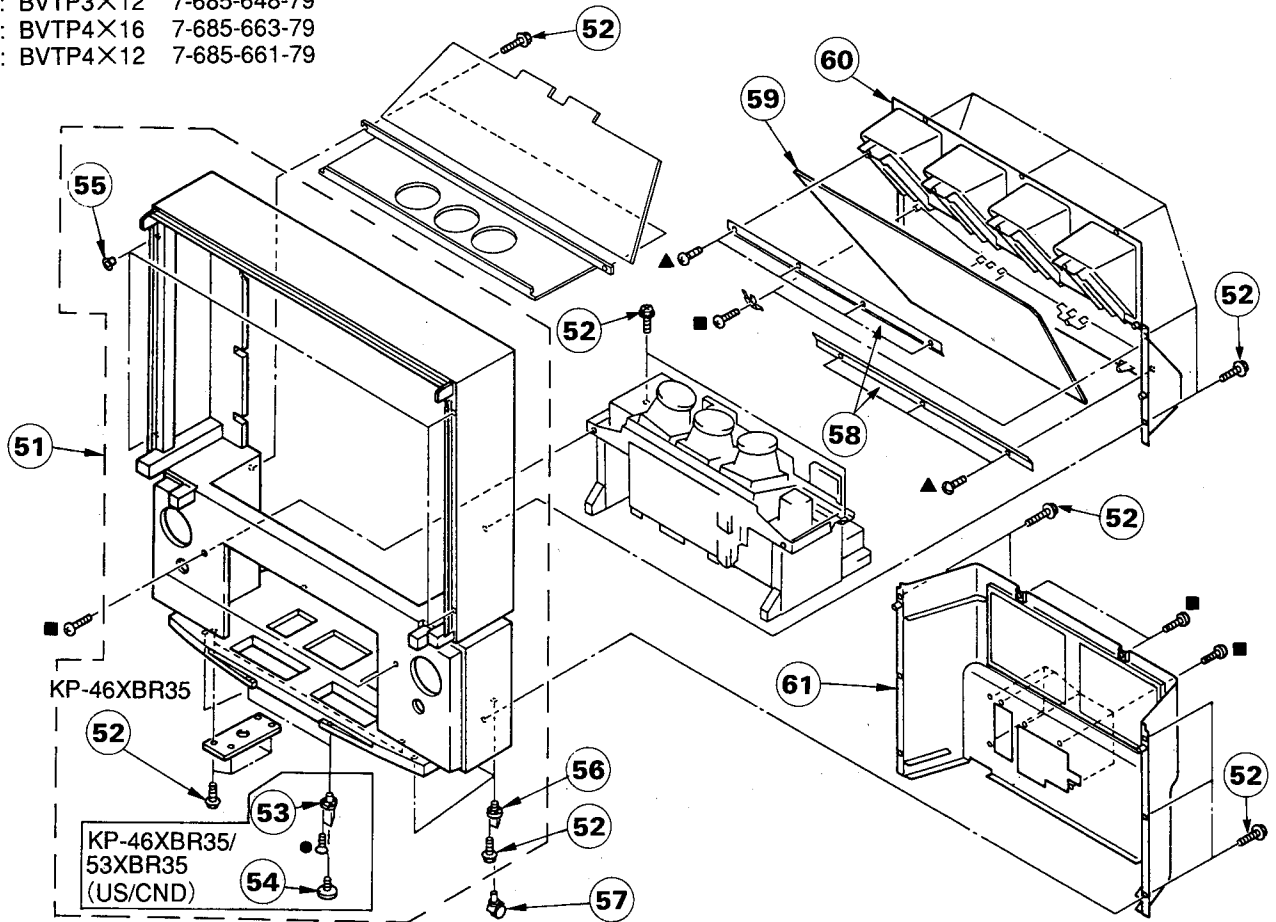

REF.NO.	PART NO.	DESCRIPTION	REMARK	REF.NO.	PART NO.	DESCRIPTION	REMARK
51	X-4031-084-1	CABINET ASSY (KP-46XBR35)	52-54, 56	58	*4-037-351-01	HOLDER, MIRROR	
	X-4031-198-1	CABINET ASSY (KP-53XBR35(U/C))	52-54, 56	59	4-037-349-01	MIRROR (53), REFLECTION (KP-53XBR35(U/C))	
	X-4031-887-1	CABINET ASSY (KP-61XBR38)	55, 56		4-037-534-01	MIRROR (46), REFLECTION (KP-46XBR35)	
52	4-378-522-11	SCREW, TAPPING, HEXAGON HEAD (KP-61XBR38)			4-040-713-01	MIRROR (61), REFLECTION (KP-61XBR38)	
	4-041-164-11	SCREW (M4X20), TAPPING (KP-46XBR35/53XBR35(U/C))		60	4-036-462-01	COVER (46"), MIRROR (KP-46XBR35)	
53	4-037-473-01	NUT, FITTING (KP-46XBR35/53XBR35(U/C))			4-036-474-01	COVER (53"), MIRROR (KP-53XBR35(U/C))/61XBR38)	
54	4-037-472-01	LEG, ADJUSTABLE (KP-46XBR35/53XBR35(U/C))		61	X-4030-549-1	COVER ASSY, BACK	
55	4-838-438-00	LATCH					
56	4-030-850-01	SOCKET, CASTER					
57	4-032-343-11	CASTER (KP-46XBR35/53XBR35(U/C))					
	4-040-508-11	CASTER (KP-61XBR38)					

Les composants identifiés par une trame et une marque Δ sont critiques pour la sécurité. Ne les remplacer que par une pièce portant le numéro spécifique.

The components identified by shading and mark Δ are critical for safety. Replace only with part number specified.

7-3. CHASSIS

- : BVTP3×12 7-685-648-79
- : BVTP4×16 7-685-663-79
- : PSW4×14 7-682-663-09
- : BVTP4×12 7-685-661-14

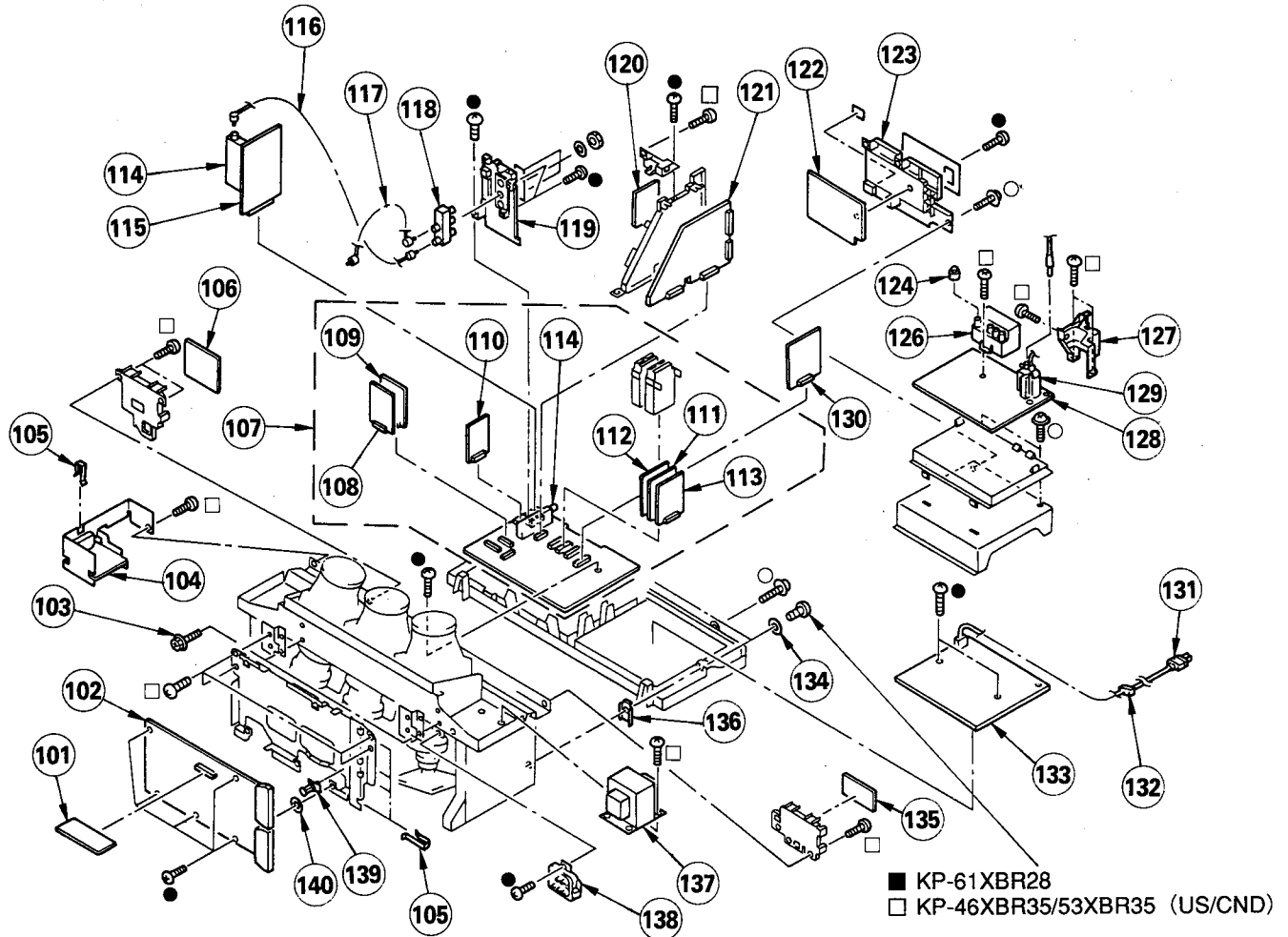

REF. NO.	PART NO.	DESCRIPTION	REMARK	REF. NO.	PART NO.	DESCRIPTION	REMARK
101	*1-650-883-11	DS BOARD		120	*A-1195-065-A	P4 BOARD, COMPLETE	
102	*A-1341-726-A	D BOARD, COMPLETE		121	*A-1394-429-A	U BOARD, COMPLETE	
103	4-041-164-11	SCREW (4X20), TAPPING		122	*A-1394-434-A	UT BOARD, COMPLETE	
104	*1-644-632-11	YA BOARD		123	4-036-138-11	PANEL, MAIN CONNECTOR	
105	*4-393-401-11	SPRING, TRANSISTOR		124	4-373-137-01	CAP (Z), RUBBER	
106	*A-1394-421-A	S BOARD, COMPLETE		126	Δ 1-453-108-11	DC BLOCK, HIGH-VOLTAGE	
107	*A-1297-104-A	A BOARD, COMPLETE (KP-53XBR35 (U/C))	108-114	127	4-034-482-01	COVER, FBT	
	*A-1297-105-A	A BOARD, COMPLETE (KP-46XBR35/61XBR38)	108-114	128	*A-1390-351-A	N BOARD, COMPLETE	
108	*A-1394-442-A	Y2 BOARD, COMPLETE		129	Δ 1-453-121-11	TRANSFORMER ASSY, FLYBACK (NX-2630B4)	
109	*A-1394-446-A	X3 BOARD, COMPLETE		130	*A-1342-214-A	V BOARD, COMPLETE	
110	*A-1195-067-A	P2 BOARD, COMPLETE		131	Δ 1-696-002-12	CORD, POWER (WITH NOISE FILTER) 7.0A/125V	
111	*A-1346-136-A	E2 BOARD, COMPLETE		132	Δ 4-388-328-12	GROMMET, AC CORD	
112	*A-1306-435-A	M BOARD, COMPLETE		133	*A-1316-178-A	G BOARD, COMPLETE	
113	*A-1346-138-A	E1 BOARD, COMPLETE		134	4-042-667-01	WASHER, WAVE	
114	Δ 1-693-102-21	TUNER (BTF-XA401)		135	*1-664-633-11	YG BOARD	
115	*A-1195-069-A	P3 BOARD, COMPLETE		136	*4-040-487-01	SPACER	
116	*1-557-056-31	CABLE, P-P		137	Δ 1-423-311-21	TRANSFORMER, POWER	
117	*1-555-400-00	CABLE, PIN		138	Δ 1-241-744-11	RESISTOR ASSY (HIGH-VOLTAGE)	
118	1-417-178-11	SELECTOR, ANTENNA (AS-2)		139	*3-670-570-21	SPACER, SUPPORT	
119	4-036-137-01	PANEL, SUB CONNECTOR		140	4-866-147-00	WASHER	

Les composants identifiés par une trame et une marque ▲ sont critiques pour la sécurité. Ne les remplacer que par une pièce portant le numéro spécifié.

The components identified by shading and mark ▲ are critical for safety. Replace only with part number specified.

7-4. PICTURE TUBE

▲ : BVTP4X12 7-685-661-79

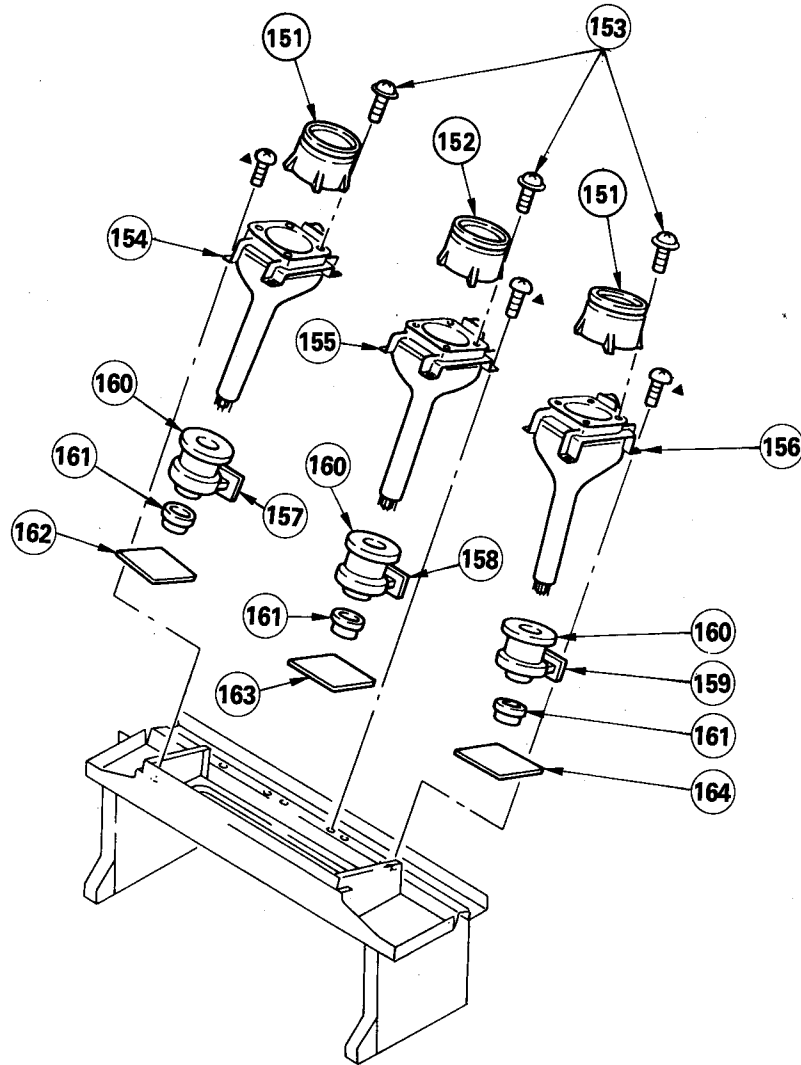

REF.NO.	PART NO.	DESCRIPTION	REMARK	REF.NO.	PART NO.	DESCRIPTION	REMARK
151	4-034-057-11	LENS (LINNIT) (KP-46XBR35/53XBR35(U/C))		156	▲8-736-635-05	PICTURE TUBE 07MK3(B) (KP-46XBR35/53XBR35(U/C))	
	4-040-131-01	LENS (LINNIT) (KP-61XBR38)			▲8-736-640-05	PICTURE TUBE 07MK2(B) (KP-61XBR38)	
152	4-034-057-01	LENS (LINNIT) (KP-46XBR35/53XBR35(U/C))		157	*A-1390-340-A	ZR BOARD, COMPLETE	
	4-040-131-11	LENS (LINNIT) (KP-61XBR38)		158	*A-1390-346-A	ZG BOARD, COMPLETE	
153	3-701-810-91	SCREW, TERMINAL		159	*A-1390-347-A	ZB BOARD, COMPLETE	
154	▲8-736-636-05	PICTURE TUBE 07MK3(R) (KP-46XBR35/53XBR35(U/C))		160	▲1-451-396-21	DEFLECTION YOKE (Y936PA)	
	▲8-736-641-05	PICTURE TUBE 07MK2(R) (KP-61XBR38)		161	▲1-452-443-13	NECK ASSY, PICTURE TUBE (NA367)	
155	▲8-736-634-05	PICTURE TUBE 07MK3(G)		162	*A-1331-259-A	CR BOARD, COMPLETE	
				163	*A-1331-260-A	CG BOARD, COMPLETE	
				164	*A-1331-261-A	CB BOARD, COMPLETE	

P4

ELECTRICAL PARTS LIST

NOTE:

The components identified by shading and mark Δ are critical for safety. Replace only with part number specified.

Les composants identifiés par une trame et une marque Δ sont critiques pour la sécurité. Ne les remplacer que par une pièce portant le numéro spécifique.

• Items marked " * " are not stocked since they are seldom required for routine service. Some delay should be anticipated when ordering these items.

• All variable and adjustable resistors have characteristic curve B, unless otherwise noted.

RESISTORS

• All resistors are in ohms
• F : nonflammable

When indicating parts by reference number, please include the board name.

CAPACITORS

COILS

• MF : μ F, PF : μ PF • MMH : mH, UH : μ H

• The components identified by \boxtimes in this manual have been carefully factory-selected for each set in order to satisfy regulations regarding X-ray radiation. Should replacement be required, replace only with the value originally used.

• * : Selected to yield optimum performance.

• There are some cases the reference number on one board overlaps on the other board. Therefore, when ordering parts by the reference number, please include the board name.

REF.NO.	PART NO.	DESCRIPTION	REMARK	REF.NO.	PART NO.	DESCRIPTION	REMARK
*A-1195-065-A	P4 BOARD, COMPLETE	*****					
<CAPACITOR>							
C1201	1-164-232-11	CERAMIC CHIP 0.01MF	10% 50V				
C1202	1-163-017-00	CERAMIC CHIP 0.0047MF	10% 50V				
C1203	1-163-105-00	CERAMIC CHIP 33PF	5% 50V				
C1204	1-163-809-11	CERAMIC CHIP 0.047MF	10% 25V				
C1205	1-163-141-00	CERAMIC CHIP 0.001MF	5% 50V				
C1206	1-163-093-00	CERAMIC CHIP 10PF	5% 50V				
C1207	1-164-232-11	CERAMIC CHIP 0.01MF	10% 50V				
C1208	1-163-237-11	CERAMIC CHIP 27PF	5% 50V				
C1210	1-163-017-00	CERAMIC CHIP 0.0047MF	10% 50V				
C1211	1-164-232-11	CERAMIC CHIP 0.01MF	10% 50V				
C1213	1-126-154-11	ELECT 47MF	20% 6.3V				
C1214	1-164-004-11	CERAMIC CHIP 0.1MF	10% 25V				
C1215	1-126-154-11	ELECT 47MF	20% 6.3V				
C1216	1-164-004-11	CERAMIC CHIP 0.1MF	10% 25V				
C1217	1-164-004-11	CERAMIC CHIP 0.1MF	10% 25V				
C1218	1-164-004-11	CERAMIC CHIP 0.1MF	10% 25V				
C1219	1-164-232-11	CERAMIC CHIP 0.01MF	10% 50V				
C1220	1-164-004-11	CERAMIC CHIP 0.1MF	10% 25V				
C1221	1-164-004-11	CERAMIC CHIP 0.1MF	10% 25V				
C1222	1-164-004-11	CERAMIC CHIP 0.1MF	10% 25V				
C1223	1-164-004-11	CERAMIC CHIP 0.1MF	10% 25V				
C1224	1-164-004-11	CERAMIC CHIP 0.1MF	10% 25V				
C1225	1-164-004-11	CERAMIC CHIP 0.1MF	10% 25V				
C1226	1-164-004-11	CERAMIC CHIP 0.1MF	10% 25V				
C1227	1-164-004-11	CERAMIC CHIP 0.1MF	10% 25V				
C1228	1-126-154-11	ELECT 47MF	20% 6.3V				
C1229	1-126-157-11	ELECT 10MF	20% 6.3V				
C1230	1-126-157-11	ELECT 10MF	20% 6.3V				
C1231	1-126-157-11	ELECT 10MF	20% 6.3V				
C1232	1-164-004-11	CERAMIC CHIP 0.1MF	10% 25V				
C1233	1-164-004-11	CERAMIC CHIP 0.1MF	10% 25V				
C1234	1-164-004-11	CERAMIC CHIP 0.1MF	10% 25V				
C1235	1-124-257-00	ELECT 2.2MF	20% 50V				
C1237	1-164-004-11	CERAMIC CHIP 0.1MF	10% 25V				
C1238	1-164-004-11	CERAMIC CHIP 0.1MF	10% 25V				
C1239	1-164-004-11	CERAMIC CHIP 0.1MF	10% 25V				
C1240	1-163-809-11	CERAMIC CHIP 0.047MF	10% 25V				
C1241	1-163-809-11	CERAMIC CHIP 0.047MF	10% 25V				
C1242	1-163-009-11	CERAMIC CHIP 0.001MF	10% 50V				
C1243	1-126-177-11	ELECT 100MF	20% 6.3V				
C1245	1-126-157-11	ELECT 10MF	20% 6.3V				
C1246	1-164-232-11	CERAMIC CHIP 0.01MF	10% 50V				
C1249	1-126-157-11	ELECT 10MF	20% 6.3V				
C1250	1-164-004-11	CERAMIC CHIP 0.1MF	10% 25V				
C1251	1-164-232-11	CERAMIC CHIP 0.01MF	10% 50V				
C1252	1-164-004-11	CERAMIC CHIP 0.1MF	10% 25V				
C1253	1-164-004-11	CERAMIC CHIP 0.1MF	10% 25V				
C1254	1-164-004-11	CERAMIC CHIP 0.1MF	10% 25V				
C1255	1-164-004-11	CERAMIC CHIP 0.1MF	10% 25V				
C1256	1-163-809-11	CERAMIC CHIP 0.047MF	10% 25V				
<FILTER>							
FL1201	1-239-550-11	FILTER, LOW PASS					
FL1202	1-239-550-11	FILTER, LOW PASS					
FL1203	1-239-550-11	FILTER, LOW PASS					
<IC>							
IC1201	8-752-352-20	IC CXD2023Q					
IC1202	8-752-062-80	IC CXA1686M					
IC1203	8-759-112-06	IC UPC78N05H					
IC1204	8-759-112-06	IC UPC78N05H					
<COIL>							
L1201	1-408-423-00	INDUCTOR 150UH					
L1202	1-414-042-21	INDUCTOR 18UH					
L1205	1-414-042-21	INDUCTOR 18UH					
<CONNECTOR>							
P4-32	*1-564-522-11	PLUG, CONNECTOR 7P					
<TRANSISTOR>							
Q1202	8-729-120-28	TRANSISTOR 2SC1623-L5L6					
Q1203	8-729-216-22	TRANSISTOR 2SA1162-G					
Q1204	8-729-120-28	TRANSISTOR 2SC1623-L5L6					
Q1205	8-729-120-28	TRANSISTOR 2SC1623-L5L6					
Q1206	8-729-120-28	TRANSISTOR 2SC1623-L5L6					
Q1207	8-729-216-22	TRANSISTOR 2SA1162-G					
Q1208	8-729-120-28	TRANSISTOR 2SC1623-L5L6					
Q1209	8-729-120-28	TRANSISTOR 2SC1623-L5L6					
Q1211	8-729-216-22	TRANSISTOR 2SA1162-G					
Q1212	8-729-120-28	TRANSISTOR 2SC1623-L5L6					
Q1213	8-729-120-28	TRANSISTOR 2SC1623-L5L6					
Q1214	8-729-216-22	TRANSISTOR 2SA1162-G					
Q1215	8-729-120-28	TRANSISTOR 2SC1623-L5L6					
Q1218	8-729-216-22	TRANSISTOR 2SA1162-G					
Q1220	8-729-901-01	TRANSISTOR DTC144EK					
<RESISTOR>							
R1201	1-216-049-00	METAL GLAZE 1K 5%	1/10W				
R1202	1-216-001-00	METAL GLAZE 10 5%	1/10W				
R1203	1-216-025-00	METAL GLAZE 100 5%	1/10W				
R1204	1-216-630-11	METAL CHIP 130 0.50%	1/10W				
R1205	1-216-639-11	METAL CHIP 330 0.50%	1/10W				

P4 P3

REF. NO.	PART NO.	DESCRIPTION	REMARK	REF. NO.	PART NO.	DESCRIPTION	REMARK
R1206	1-216-620-11	METAL CHIP	51 0.50% 1/10W	R1284	1-216-025-00	METAL GLAZE	100 5% 1/10W
R1207	1-216-025-00	METAL GLAZE	100 5% 1/10W			<CRYSTAL>	
R1208	1-216-025-00	METAL GLAZE	100 5% 1/10W	X1201	1-577-611-11	OSCILATOR, CERAMIC	
R1209	1-216-635-11	METAL CHIP	220 0.50% 1/10W	X1202	1-567-878-11	VIBRATOR, CRYSTAL	
R1210	1-216-049-00	METAL GLAZE	1K 5% 1/10W			*****	
R1211	1-216-043-00	METAL GLAZE	560 5% 1/10W			*A-1195-069-A P3 BOARD, COMPLETE	
R1212	1-216-067-00	METAL GLAZE	5.6K 5% 1/10W			*****	
R1213	1-216-001-00	METAL GLAZE	10 5% 1/10W			<CAPACITOR>	
R1214	1-216-049-00	METAL GLAZE	1K 5% 1/10W	C2001	1-124-910-11	ELECT	47MF 20% 50V
R1215	1-216-069-00	METAL GLAZE	6.8K 5% 1/10W	C2002	1-124-910-11	ELECT	47MF 20% 50V
R1216	1-216-041-00	METAL GLAZE	470 5% 1/10W	C2003	1-124-119-00	ELECT	330MF 20% 16V
R1217	1-216-077-00	METAL GLAZE	15K 5% 1/10W	C2004	1-164-232-11	CERAMIC CHIP	0.01MF 10% 50V
R1218	1-216-661-11	METAL CHIP	2.7K 0.50% 1/10W	C2005	1-124-261-00	ELECT	10MF 20% 50V
R1219	1-216-657-11	METAL CHIP	1.8K 0.50% 1/10W	C2006	1-164-232-11	CERAMIC CHIP	0.01MF 10% 50V
R1220	1-216-657-11	METAL CHIP	1.8K 0.50% 1/10W	C2007	1-126-157-11	ELECT	10MF 20% 16V
R1221	1-216-023-00	METAL GLAZE	82 5% 1/10W	C2008	1-163-031-11	CERAMIC CHIP	0.01MF 50V
R1222	1-216-103-91	METAL GLAZE	180K 5% 1/10W	C2009	1-136-157-00	FILM	0.022MF 5% 50V
R1223	1-216-089-91	METAL GLAZE	47K 5% 1/10W	C2010	1-164-161-11	CERAMIC CHIP	0.0022MF 50V
R1224	1-216-089-91	METAL GLAZE	47K 5% 1/10W	C2011	1-126-157-11	ELECT	10MF 20% 16V
R1225	1-216-653-11	METAL CHIP	1.2K 0.50% 1/10W	C2013	1-126-301-11	ELECT	1MF 20% 50V
R1226	1-216-666-11	METAL CHIP	4.3K 0.50% 1/10W	C2014	1-164-161-11	CERAMIC CHIP	0.0022MF 10% 50V
R1228	1-216-057-00	METAL GLAZE	2.2K 5% 1/10W	C2015	1-163-117-00	CERAMIC CHIP	100PF 5% 50V
R1229	1-216-043-00	METAL GLAZE	560 5% 1/10W	C2016	1-163-109-00	CERAMIC CHIP	47PF 5% 50V
R1230	1-216-075-00	METAL GLAZE	12K 5% 1/10W	C2017	1-163-109-00	CERAMIC CHIP	47PF 5% 50V
R1231	1-216-073-00	METAL GLAZE	10K 5% 1/10W	C2018	1-124-465-00	ELECT	0.47MF 20% 50V
R1232	1-216-689-11	METAL GLAZE	39K 5% 1/10W	C2019	1-126-103-11	ELECT	470MF 20% 16V
R1233	1-216-077-00	METAL GLAZE	15K 5% 1/10W	C2020	1-163-031-11	CERAMIC CHIP	0.01MF 50V
R1234	1-216-035-00	METAL GLAZE	270 5% 1/10W	C2021	1-126-157-11	ELECT	10MF 20% 16V
R1235	1-216-037-00	METAL GLAZE	330 5% 1/10W	C2022	1-164-232-11	CERAMIC CHIP	0.01MF 10% 50V
R1238	1-216-073-00	METAL GLAZE	10K 5% 1/10W	C2023	1-163-119-00	CERAMIC CHIP	120PF 5% 50V
R1239	1-216-073-00	METAL GLAZE	10K 5% 1/10W	C2024	1-124-465-00	ELECT	0.47MF 20% 50V
R1241	1-216-035-00	METAL GLAZE	270 5% 1/10W	C2025	1-126-157-11	ELECT	10MF 20% 16V
R1242	1-216-043-00	METAL GLAZE	560 5% 1/10W	C2026	1-163-101-00	CERAMIC CHIP	22PF 5% 50V
R1243	1-216-689-11	METAL GLAZE	39K 5% 1/10W	C2027	1-163-103-00	CERAMIC CHIP	27PF 5% 50V
R1244	1-216-025-00	METAL GLAZE	100 5% 1/10W	C2028	1-163-107-00	CERAMIC CHIP	39PF 5% 50V
R1245	1-216-001-00	METAL GLAZE	10 5% 1/10W	C2029	1-124-477-11	ELECT	47MF 20% 16V
R1246	1-216-077-00	METAL GLAZE	15K 5% 1/10W	C2031	1-124-910-11	ELECT	47MF 20% 50V
R1247	1-216-089-91	METAL GLAZE	47K 5% 1/10W	C2032	1-164-232-11	CERAMIC CHIP	0.01MF 10% 50V
R1248	1-216-635-11	METAL CHIP	220 0.50% 1/10W	C2034	1-126-157-11	ELECT	10MF 20% 16V
R1249	1-216-025-00	METAL GLAZE	100 5% 1/10W	C2035	1-126-157-11	ELECT	10MF 20% 16V
R1250	1-216-043-00	METAL GLAZE	560 5% 1/10W	C2036	1-163-025-11	CERAMIC CHIP	0.001MF 50V
R1251	1-216-057-00	METAL GLAZE	2.2K 5% 1/10W	C2037	1-124-477-11	ELECT	47MF 20% 16V
R1252	1-216-295-00	METAL GLAZE	0 5% 1/10W	C2038	1-164-161-11	CERAMIC CHIP	0.0022MF 10% 50V
R1253	1-216-067-00	METAL GLAZE	5.6K 5% 1/10W	C2039	1-124-477-11	ELECT	47MF 20% 16V
R1254	1-216-035-00	METAL GLAZE	270 5% 1/10W	C2040	1-124-903-11	ELECT	1MF 20% 50V
R1255	1-216-639-11	METAL CHIP	330 0.50% 1/10W	C2041	1-137-366-11	FILM	0.0022MF 5% 50V
R1256	1-216-035-00	METAL GLAZE	270 5% 1/10W	C2042	1-124-902-00	ELECT	0.47MF 20% 50V
R1257	1-216-645-11	METAL CHIP	560 0.50% 1/10W	C2043	1-136-161-00	FILM	0.047MF 5% 50V
R1258	1-216-073-00	METAL GLAZE	10K 5% 1/10W	C2044	1-163-031-11	CERAMIC CHIP	0.01MF 50V
R1259	1-216-644-11	METAL CHIP	510 0.50% 1/10W	C2045	1-126-157-11	ELECT	10MF 20% 16V
R1260	1-216-075-00	METAL GLAZE	12K 5% 1/10W	C2046	1-136-169-00	FILM	0.22MF 5% 50V
R1261	1-216-025-00	METAL GLAZE	100 5% 1/10W	C2047	1-124-463-00	ELECT	0.1MF 20% 50V
R1262	1-216-049-00	METAL GLAZE	1K 5% 1/10W	C2048	1-163-031-11	CERAMIC CHIP	0.01MF 50V
R1263	1-216-025-00	METAL GLAZE	100 5% 1/10W	C2049	1-136-165-00	FILM	0.1MF 5% 50V
R1264	1-216-025-00	METAL GLAZE	100 5% 1/10W	C2050	1-124-902-00	ELECT	0.47MF 20% 50V
R1265	1-216-061-00	METAL GLAZE	3.3K 5% 1/10W	C2051	1-126-157-11	ELECT	10MF 20% 16V
R1266	1-216-001-00	METAL GLAZE	10 5% 1/10W	C2052	1-163-129-00	CERAMIC CHIP	330PF 5% 50V
R1267	1-216-057-00	METAL GLAZE	2.2K 5% 1/10W	C2053	1-163-093-00	CERAMIC CHIP	10PF 5% 50V
R1268	1-216-089-91	METAL GLAZE	47K 5% 1/10W				
R1269	1-216-049-00	METAL GLAZE	1K 5% 1/10W				
R1270	1-216-295-00	METAL GLAZE	0 5% 1/10W				
R1273	1-216-049-00	METAL GLAZE	1K 5% 1/10W				
R1274	1-216-295-00	METAL GLAZE	0 5% 1/10W				
R1276	1-216-295-00	METAL GLAZE	0 5% 1/10W				

P3

Les composants identifiés par une trame et par une marque Δ sont d'une importance critique pour la sécurité. Ne les remplacer que par des pièces de numéro spécifié.

The components identified by shading and mark Δ are critical for safety. Replace only with part number specified.

REF. NO.	PART NO.	DESCRIPTION	REMARK	REF. NO.	PART NO.	DESCRIPTION	REMARK
C2054	1-163-093-00	CERAMIC CHIP 10PF	5%	50V	<CONNECTOR>		
C2055	1-163-117-00	CERAMIC CHIP 100PF	5%	50V			
C2056	1-136-161-00	FILM 0.047MF	5%	50V			
C2057	1-124-477-11	ELECT 47MF	20%	16V			
C2058	1-163-031-11	CERAMIC CHIP 0.01MF		50V	P3-39	*1-564-521-11	PLUG, CONNECTOR 6P
C2059	1-136-177-00	FILM 1MF	5%	50V	P3-40	*1-564-519-11	PLUG, CONNECTOR 4P
C2060	1-136-153-00	FILM 0.01MF	5%	50V	P3-41	*1-564-519-11	PLUG, CONNECTOR 4P
C2061	1-163-031-11	CERAMIC CHIP 0.01MF		50V	<TRANSISTOR>		
C2062	1-163-095-00	CERAMIC CHIP 12PF	5%	50V			
C2063	1-163-101-00	CERAMIC CHIP 22PF	5%	50V	Q2001	8-729-216-22	TRANSISTOR 2SA1162-G
C2064	1-164-161-11	CERAMIC CHIP 0.0022MF	10%	50V	Q2002	8-729-120-28	TRANSISTOR 2SC1623-L5L6
C2065	1-126-320-11	ELECT 10MF	20%	16V	Q2003	8-729-120-28	TRANSISTOR 2SC1623-L5L6
C2066	1-126-157-11	ELECT 10MF	20%	16V	Q2004	8-729-216-22	TRANSISTOR 2SA1162-G
C2067	1-126-157-11	ELECT 10MF	20%	16V	Q2005	8-729-120-28	TRANSISTOR 2SC1623-L5L6
C2068	1-124-916-11	ELECT 22MF	20%	50V	Q2006	8-729-120-28	TRANSISTOR 2SC1623-L5L6
C2070	1-163-257-11	CERAMIC CHIP 180PF	5%	50V	Q2007	8-729-216-22	TRANSISTOR 2SA1162-G
C2073	1-124-477-11	ELECT 47MF	20%	16V	Q2008	8-729-920-74	TRANSISTOR 2SC2412K-QR
C2075	1-163-117-00	CERAMIC CHIP 100PF	5%	50V	Q2009	8-729-216-22	TRANSISTOR 2SA1162-G
					Q2010	8-729-120-28	TRANSISTOR 2SC1623-L5L6
<NETWORK>					Q2011	8-729-216-22	TRANSISTOR 2SA1162-G
CP2001	1-236-472-11	NETWORK, RES, THICK FILM			Q2012	8-729-216-22	TRANSISTOR 2SA1162-G
<TRIMMER>					Q2015	8-729-216-22	TRANSISTOR 2SA1162-G
CV2001	1-141-245-00	CAP, TRIMMER			Q2016	8-729-120-28	TRANSISTOR 2SC1623-L5L6
<DIODE>					Q2017	8-729-120-28	TRANSISTOR 2SC1623-L5L6
D2003	8-719-106-16	DIODE RD6.8M-B1			Q2018	8-729-420-81	TRANSISTOR 2SD874A-R
D2004	8-719-404-46	DIODE MA110			Q2019	8-729-216-22	TRANSISTOR 2SA1162-G
D2005	8-719-404-46	DIODE MA110			Q2020	8-729-216-22	TRANSISTOR 2SA1162-G
D2006	8-719-105-45	DIODE RD3.3M-B1			Q2021	8-729-120-28	TRANSISTOR 2SC1623-L5L6
D2007	8-719-911-19	DIODE ISS119			Q2022	8-729-120-28	TRANSISTOR 2SC1623-L5L6
<FILTER>					Q2023	8-729-120-28	TRANSISTOR 2SC1623-L5L6
FL2001	1-235-941-11	YC MODULE			Q2024	8-729-120-28	TRANSISTOR 2SC1623-L5L6
<IC>					Q2025	8-729-216-22	TRANSISTOR 2SA1162-G
IC2001	8-759-231-58	IC TA7812S			Q2026	8-729-216-22	TRANSISTOR 2SA1162-G
IC2002	8-759-700-48	IC NJM2903S			Q2027	8-729-216-22	TRANSISTOR 2SA1162-G
IC2003	8-759-805-37	IC L78LR05D-MA			Q2028	8-729-216-22	TRANSISTOR 2SA1162-G
IC2004	8-759-066-51	IC MB88733-143			Q2029	8-729-216-22	TRANSISTOR 2SA1162-G
IC2005	8-759-803-25	IC CXK1006L			Q2030	8-729-216-22	TRANSISTOR 2SA1162-G
IC2006	8-752-006-12	IC CX20061			Q2031	8-729-216-22	TRANSISTOR 2SA1162-G
IC2007	8-752-033-32	IC CXA1228S			Q2032	8-729-120-28	TRANSISTOR 2SC1623-L5L6
<JACK>					Q2033	8-729-600-12	TRANSISTOR 2SK108-C
J2001	*1-573-962-11	CONNECTOR (MALE) 50P			Q2034	8-729-216-22	TRANSISTOR 2SA1162-G
<COIL>					Q2035	8-729-120-28	TRANSISTOR 2SC1623-L5L6
L2002	1-410-663-31	INDUCTOR 10UH			Q2036	8-729-120-28	TRANSISTOR 2SC1623-L5L6
L2003	1-410-667-31	INDUCTOR 22UH			<RESISTOR>		
L2004	1-410-663-31	INDUCTOR 10UH					
L2009	1-410-663-31	INDUCTOR 10UH			R2002	Δ 1-216-357-91	METAL OXIDE 4.7 5% 1W
L2010	1-410-677-31	INDUCTOR 180UH			R2003	1-216-061-00	METAL GLAZE 3.3K 5% 1/10W
L2011	1-410-677-31	INDUCTOR 180UH			R2004	1-216-049-00	METAL GLAZE 1K 5% 1/10W
					R2006	1-216-689-11	METAL GLAZE 39K 5% 1/10W
					R2007	1-216-063-00	METAL GLAZE 3.9K 5% 1/10W
					R2008	1-216-081-00	METAL GLAZE 22K 5% 1/10W
					R2009	1-216-081-00	METAL GLAZE 22K 5% 1/10W
					R2010	1-216-065-00	METAL GLAZE 4.7K 5% 1/10W
					R2011	1-216-079-00	METAL GLAZE 18K 5% 1/10W
					R2012	1-216-089-91	METAL GLAZE 47K 5% 1/10W
					R2013	1-216-079-00	METAL GLAZE 18K 5% 1/10W
					R2014	1-216-089-91	METAL GLAZE 47K 5% 1/10W
					R2015	1-216-033-00	METAL GLAZE 220 5% 1/10W
					R2016	1-216-295-00	METAL GLAZE 0 5% 1/10W
					R2017	1-216-047-00	METAL GLAZE 820 5% 1/10W
					R2018	1-216-049-00	METAL GLAZE 1K 5% 1/10W
					R2019	1-216-049-00	METAL GLAZE 1K 5% 1/10W
					R2020	1-216-037-00	METAL GLAZE 330 5% 1/10W
					R2021	1-216-095-00	METAL GLAZE 82K 5% 1/10W
					R2022	1-216-109-00	METAL GLAZE 330K 5% 1/10W

A

Les composants identifiés par une trame et par une marque Δ sont d'une importance critique pour la sécurité. Ne les remplacer que par des pièces de numéro spécifié.

The components identified by shading and mark Δ are critical for safety. Replace only with part number specified.

REF. NO.	PART NO.	DESCRIPTION	REMARK	REF. NO.	PART NO.	DESCRIPTION	REMARK
*****				C502	1-126-182-11	ELECT	0.47MF 20% 50V
*****				C503	1-130-487-00	MYLAR	0.022MF 5% 50V
*A-1297-104-A	A BOARD, COMPLETE (KP-53XBR35(U/C))			C504	1-136-153-00	FILM	0.01MF 5% 50V
*****				C507	1-106-383-00	MYLAR	0.047MF 200V
*A-1297-105-A	A BOARD, COMPLETE (KP-46XBR35/61XBR38)			C508	1-102-973-00	CERAMIC	100PF 5% 50V
*****				C509	1-102-030-00	CERAMIC	330PF 10% 500V
4-365-216-00	SPACER, MICA			C510	Δ 1-136-565-11	FILM	0.015MF 3% 1.4KV
4-382-854-11	SCREW (M3X10), P, SW (+)			C512	Δ 1-136-598-11	FILM	3MF 5% 200V
<CONNECTOR>				C513	1-136-153-00	FILM	0.01MF 5% 50V
A-1	*1-564-514-11	PLUG, CONNECTOR 11P		C514	1-124-477-11	ELECT	47MF 20% 16V
A-2	*1-564-512-11	PLUG, CONNECTOR 9P		C522	1-123-024-21	ELECT	33MF 160V
A-3	*1-564-507-11	PLUG, CONNECTOR 4P		C523	1-106-383-00	MYLAR	0.047MF 200V
A-4	*1-564-508-11	PLUG, CONNECTOR 5P		C528	1-124-662-11	ELECT	220MF 20% 50V
A-5	*1-564-511-51	PLUG, CONNECTOR 8P		C534	1-124-011-00	ELECT	220MF 20% 16V
A-7	*1-564-505-11	PLUG, CONNECTOR 2P		C535	1-124-011-00	ELECT	220MF 20% 16V
A-9	*1-564-505-11	PLUG, CONNECTOR 2P		C536	1-124-662-11	ELECT	220MF 20% 50V
A-10	*1-564-511-81	PLUG, CONNECTOR 8P		C537	1-124-662-11	ELECT	220MF 20% 50V
A-11	*1-564-511-71	PLUG, CONNECTOR 8P		C539	1-124-907-11	ELECT	10MF 20% 50V
A-12	1-573-979-21	CONNECTOR, BOARD TO BOARD 11P		C542	1-136-153-00	FILM	0.01MF 5% 50V
A-13	1-573-979-21	CONNECTOR, BOARD TO BOARD 11P		C543	1-136-153-00	FILM	0.01MF 5% 50V
A-14	*1-564-513-11	PLUG, CONNECTOR 10P		C544	1-136-153-00	FILM	0.01MF 5% 50V
A-15	*1-564-508-11	PLUG, CONNECTOR 5P		C545	1-136-153-00	FILM	0.01MF 5% 50V
A-16	*1-564-508-11	PLUG, CONNECTOR 5P		C569	1-126-355-11	ELECT	33MF 20% 160V
A-17	*1-564-508-11	PLUG, CONNECTOR 5P		C1401	1-124-910-11	ELECT	47MF 20% 50V
A-18	*1-691-291-11	PIN, CONNECTOR (PC BOARD) 5P		C1402	1-126-157-11	ELECT	10MF 20% 16V
A-19	*1-691-291-11	PIN, CONNECTOR (PC BOARD) 5P		C1405	1-124-910-11	ELECT	47MF 20% 50V
A-20	*1-691-291-11	PIN, CONNECTOR (PC BOARD) 5P		C1406	1-126-101-11	ELECT	100MF 20% 16V
A-21	1-508-786-00	PIN, CONNECTOR (5MM PITCH) 2P		C1407	1-126-057-11	ELECT	2200MF 20% 50V
A-22	1-573-979-21	CONNECTOR, BOARD TO BOARD 11P		C1408	1-136-165-00	FILM	0.1MF 5% 50V
A-25	*1-564-506-11	PLUG, CONNECTOR 3P		C1409	1-136-165-00	FILM	0.1MF 5% 50V
A-27	1-573-297-21	CONNECTOR, BOARD TO BOARD 18P		C1413	1-124-234-00	ELECT	22MF 20% 16V
A-28	*1-564-508-11	PLUG, CONNECTOR 5P		C1424	1-126-057-11	ELECT	2200MF 20% 50V
A-38	1-564-505-11	PLUG, CONNECTOR 2P		C1425	1-126-057-11	ELECT	2200MF 20% 50V
A-56	*1-564-508-11	PLUG, CONNECTOR 5P		C1426	1-126-157-11	ELECT	10MF 20% 16V
P3-1	*1-573-960-11	CONNECTOR (FEMALE) 50P		C1429	1-126-101-11	ELECT	100MF 20% 16V
<CAPACITOR>				C1430	1-126-101-11	ELECT	100MF 20% 16V
C201	1-124-910-11	ELECT	47MF 20% 50V	C1431	1-124-916-11	ELECT	22MF 20% 25V
C202	1-124-903-11	ELECT	1MF 20% 50V	C1440	1-126-336-11	ELECT	220MF 20% 25V
C203	1-130-495-00	MYLAR	0.1MF 5% 50V	C1601	1-130-483-00	MYLAR	0.01MF 5% 50V
C204	1-124-477-11	ELECT	47MF 20% 16V	C1603	1-136-153-00	FILM	0.01MF 5% 50V
C205	1-124-557-11	ELECT	1000MF 20% 25V	C1607	1-124-907-11	ELECT	10MF 20% 50V
C206	1-126-101-11	ELECT	100MF 20% 16V	C1608	1-136-153-00	FILM	0.01MF 5% 50V
C207	1-124-286-00	ELECT	33MF 20% 16V	C1609	1-136-153-00	FILM	0.01MF 5% 50V
C210	1-102-121-00	CERAMIC	0.0022MF 10% 50V	C1610	1-124-916-11	ELECT	22MF 20% 50V
C212	1-126-803-11	ELECT	47MF 20% 16V	<DIODE>			
C213	1-126-103-11	ELECT	470MF 20% 16V	D201	8-719-121-24	DIODE RD9.1ESL	
C214	1-126-101-11	ELECT	100MF 20% 16V	D202	8-719-121-24	DIODE RD9.1ESL	
C215	1-126-803-11	ELECT	47MF 20% 50V	D203	8-719-911-19	DIODE 1SS119	
C216	1-126-101-11	ELECT	100MF 20% 16V	D204	8-719-911-19	DIODE 1SS119	
C217	1-126-803-11	ELECT	47MF 20% 25V	D205	8-719-110-36	DIODE RD13ESB2	
C218	1-126-103-11	ELECT	470MF 20% 16V	D206	8-719-911-19	DIODE 1SS119	
C219	1-124-443-00	ELECT	100MF 20% 10V	D207	8-719-911-19	DIODE 1SS119	
C220	1-126-803-11	ELECT	47MF 20% 25V	D208	8-719-911-19	DIODE 1SS119	
C223	1-126-803-11	ELECT	47MF 20% 25V	D209	8-719-911-19	DIODE 1SS119	
C224	1-124-261-00	ELECT	10MF 20% 50V	D211	8-719-110-36	DIODE RD13ESB2	
C225	1-124-120-11	ELECT	220MF 20% 16V	D213	8-719-110-78	DIODE RD33ESB2	
C226	1-124-120-11	ELECT	220MF 20% 16V	D214	8-719-911-19	DIODE 1SS119	
C227	1-124-621-11	ELECT	3300MF 20% 6.3V	D215	8-719-911-19	DIODE 1SS119	
C299	1-126-101-11	ELECT	100MF 20% 16V	D216	8-719-911-19	DIODE 1SS119	
				D217	8-719-911-19	DIODE 1SS119	

The components identified by shading and mark Δ are critical for safety. Replace only with part number specified.

Les composants identifiés par une trame et par une marque Δ sont d'une importance critique pour la sécurité. Ne les remplacer que par des pièces de numéro spécifié.

A

REF. NO.	PART NO.	DESCRIPTION	REMARK	REF. NO.	PART NO.	DESCRIPTION	REMARK
D219	8-719-911-19	DIODE 1SS119		Q502	8-729-014-88	TRANSISTOR 2SC4891-CA	
D220	8-719-510-48	DIODE DIN20R			4-382-854-11	SCREW (M3X10), P, SW (+); Q502	
D221	8-719-911-19	DIODE 1SS119		Q504	8-729-119-78	TRANSISTOR 2SC2785-HFE	
D222	8-719-911-19	DIODE 1SS119		Q505	8-729-201-32	TRANSISTOR 2SA1013-0	
D223	8-719-911-19	DIODE 1SS119		Q506	8-729-201-32	TRANSISTOR 2SA1013-0	
D501	8-719-971-20	DIODE ERC38-06		Q507	8-729-304-92	TRANSISTOR 2SB649A-C	
D502	8-719-971-20	DIODE ERC38-06		Q508	8-729-204-16	TRANSISTOR 2SA1301-0	
D503	8-719-300-80	DIODE RU-1C			4-382-854-11	SCREW (M3X10), P, SW (+); Q508	
D504	8-719-109-88	DIODE RD5.6ESB1		Q509	8-729-119-78	TRANSISTOR 2SC2785-HFE	
D505	8-719-900-63	DIODE V06C (KP-46XBR35/61XBR38)		Q510	8-729-119-78	TRANSISTOR 2SC2785-HFE	
D506	8-719-900-63	DIODE V06C (KP-46XBR35/61XBR38)		Q511	8-729-119-76	TRANSISTOR 2SA1175-HFE	
D507	8-719-970-89	DIODE DD50R		Q512	8-729-119-78	TRANSISTOR 2SC2785-HFE	
D509	8-719-911-19	DIODE 1SS119		Q1401	8-729-119-78	TRANSISTOR 2SC2785-HFE	
D510	8-719-109-71	DIODE RD3.9ESB1		Q1402	8-729-900-63	TRANSISTOR DTA124ES	
D511	8-719-911-19	DIODE 1SS119		Q1407	8-729-119-78	TRANSISTOR 2SC2785-HFE	
D512	8-719-911-19	DIODE 1SS119		Q1408	8-729-119-78	TRANSISTOR 2SC2785-HFE	
D513	8-719-911-19	DIODE 1SS119		Q1601	8-729-119-78	TRANSISTOR 2SC2785-HFE	
D514	8-719-911-19	DIODE 1SS119		Q1602	8-729-119-76	TRANSISTOR 2SA1175-HFE	
D515	8-719-911-19	DIODE 1SS119		Q1603	8-729-119-76	TRANSISTOR 2SA1175-HFE	
D1401	8-719-911-19	DIODE 1SS119		Q1604	8-729-119-76	TRANSISTOR 2SA1175-HFE	
D1402	8-719-911-19	DIODE 1SS119		Q1605	8-729-119-78	TRANSISTOR 2SC2785-HFE	
D1403	8-719-911-19	DIODE 1SS119		Q1606	8-729-119-78	TRANSISTOR 2SC2785-HFE	
D1404	8-719-110-88	DIODE RD39ESB2		Q1620	8-729-119-76	TRANSISTOR 2SA1175-HFE	
D1405	8-719-110-88	DIODE RD39ESB2					
D1406	8-719-911-19	DIODE 1SS119					
D1407	8-719-110-88	DIODE RD39ESB2					
D1408	8-719-911-19	DIODE 1SS119					
D1409	8-719-110-88	DIODE RD39ESB2					
D1410	8-719-911-19	DIODE 1SS119					
D1607	8-719-911-19	DIODE 1SS119					
D1608	8-719-911-19	DIODE 1SS119					
		<IC>					
IC201	8-749-920-58	IC SI-3090CA					
IC204	8-759-231-53	IC TA7805S					
IC205	8-759-144-82	IC UPC2405HF					
IC206	8-759-231-58	IC TA7812S					
IC207	8-749-920-58	IC SI-3090CA					
IC506	8-752-057-18	IC CXA1315P					
IC1401	8-759-246-70	IC TA8216H					
IC1601	8-752-058-71	IC CXA1656S					
		<JACK>					
J202	1-507-562-00	JACK					
J203	1-507-562-00	JACK					
		<COIL>					
L201	1-408-429-00	INDUCTOR 470UH					
L205	1-410-645-31	INDUCTOR 100UH					
L206	1-408-416-00	INDUCTOR 39UH					
L212	1-410-312-11	INDUCTOR 0.22UH					
L501	Δ 1-460-196-11	COIL, HORIZONTAL LINEARITY					
L502	1-459-313-00	COIL WITH CORE (HWC)					
L515	1-410-645-31	INDUCTOR 100UH					
		<TRANSISTOR>					
Q201	8-729-119-78	TRANSISTOR 2SC2785-HFE					
Q202	8-729-119-78	TRANSISTOR 2SC2785-HFE					
Q203	8-729-119-76	TRANSISTOR 2SA1175-HFE					
Q501	8-729-119-80	TRANSISTOR 2SC2688-LK					
		<RESISTOR>					
R201	1-247-807-31	CARBON 100 5%	1/4W F				
R202	1-247-807-31	CARBON 100 5%	1/4W F				
R203	1-249-425-11	CARBON 4.7K 5%	1/4W				
R204	1-249-441-11	CARBON 100K 5%	1/4W				
R214	1-249-429-11	CARBON 10K 5%	1/4W				
R215	1-249-437-11	CARBON 47K 5%	1/4W				
R216	1-249-377-11	CARBON 0.47 5%	1/4W F				
R219	1-249-426-11	CARBON 5.6K 5%	1/4W				
R221	1-249-409-11	CARBON 220 5%	1/4W				
R222	1-249-436-11	CARBON 39K 5%	1/4W				
R223	1-249-434-11	CARBON 27K 5%	1/4W				
R224	1-249-409-11	CARBON 220 5%	1/4W				
R225	1-249-417-11	CARBON 1K 5%	1/4W				
R229	Δ 1-215-921-71	METAL OXIDE 4.7K 5%	3W F				
R230	Δ 1-215-921-71	METAL OXIDE 4.7K 5%	3W F				
R231	1-249-409-11	CARBON 220 5%	1/4W F				
R232	Δ 1-216-469-71	METAL OXIDE 12 5%	3W F				
R233	1-249-409-11	CARBON 220 5%	1/4W				
R234	1-249-409-11	CARBON 220 5%	1/4W				
R235	1-249-409-11	CARBON 220 5%	1/4W				
R236	1-249-409-11	CARBON 220 5%	1/4W				
R237	1-249-409-11	CARBON 220 5%	1/4W				
R238	1-249-409-11	CARBON 220 5%	1/4W				
R239	1-249-409-11	CARBON 220 5%	1/4W				
R240	Δ 1-216-469-71	METAL OXIDE 12 5%	3W F				
R241	1-249-401-11	CARBON 47 5%	1/4W				
R242	Δ 1-216-469-71	METAL OXIDE 12 5%	3W F				
R243	Δ 1-217-288-11	WIREWOUND 1.5 10%	5W F				
R244	Δ 1-217-296-11	WIREWOUND 6.8 10%	5W F				
R296	1-249-417-11	CARBON 1K 5%	1/4W				
R501	1-247-895-00	CARBON 470K 5%	1/4W				
R502	1-249-377-11	CARBON 0.47 5%	1/4W F				
R503	1-249-377-11	CARBON 0.47 5%	1/4W F				
R504	1-249-417-11	CARBON 1K 5%	1/4W				
R505	1-249-423-11	CARBON 3.3K 5%	1/4W				
R506	Δ 1-215-922-91	METAL OXIDE 6.8K 5%	3W F				
R507	1-249-429-11	CARBON 10K 5%	1/4W F				
R508	Δ 1-216-373-91	METAL OXIDE 2.2 5%	2W F				

A **E1**

Les composants identifiés par une trame et par une marque **A** sont d'une importance critique pour la sécurité. Ne les remplacer que par des pièces de numéro spécifié.

The components identified by shading and mark **A** are critical for safety. Replace only with part number specified.

REF. NO.	PART NO.	DESCRIPTION	REMARK
R509	A 1-216-478-91	METAL OXIDE	390 5% 3W F
R511	1-247-811-31	CARBON	150 5% 1/4W
R512	1-249-421-11	CARBON	2.2K 5% 1/4W F
R513	1-249-417-11	CARBON	1K 5% 1/4W
R514	A 1-216-441-91	METAL OXIDE	27K 5% 1W F
R515	1-249-432-11	CARBON	18K 5% 1/4W F
R516	1-249-417-11	CARBON	1K 5% 1/4W
R517	1-249-427-11	CARBON	6.8K 5% 1/4W F
R518	1-249-422-11	CARBON	2.7K 5% 1/4W F
R519	1-249-417-11	CARBON	1K 5% 1/4W F
R520	A 1-215-925-91	METAL OXIDE	22K 5% 3W F
R521	A 1-215-925-91	METAL OXIDE	22K 5% 3W F
R522	1-249-421-11	CARBON	2.2K 5% 1/4W
R523	1-249-434-11	CARBON	27K 5% 1/4W
R524	1-249-434-11	CARBON	27K 5% 1/4W
R525	A 1-215-922-91	METAL OXIDE	6.8K 5% 3W F
R526	1-249-417-11	CARBON	1K 5% 1/4W
R528	A 1-216-447-91	METAL OXIDE	27 5% 2W F
R529	A 1-216-447-91	METAL OXIDE	27 5% 2W F
R530	1-249-431-11	CARBON	15K 5% 1/4W
R531	1-249-431-11	CARBON	15K 5% 1/4W
R532	1-249-385-11	CARBON	2.2 5% 1/4W F
R533	1-247-807-31	CARBON	100 5% 1/4W
R534	1-247-807-31	CARBON	100 5% 1/4W
R535	1-247-807-31	CARBON	100 5% 1/4W
R536	A 1-217-316-11	WIREWOUND	330 10% 5W F (KP-46XBR35/61XBR38)
R537	A 1-217-316-11	WIREWOUND	330 10% 5W F (KP-46XBR35/61XBR38)
R550	1-249-385-11	CARBON	2.2 5% 1/4W F
R558	1-249-385-11	CARBON	2.2 5% 1/4W F
R559	1-249-409-11	CARBON	220 5% 1/4W
R560	1-249-409-11	CARBON	220 5% 1/4W
R563	1-249-429-11	CARBON	10K 5% 1/4W
R564	1-249-429-11	CARBON	10K 5% 1/4W
R565	1-249-427-11	CARBON	6.8K 5% 1/4W
R566	1-249-427-11	CARBON	6.8K 5% 1/4W
R567	1-249-427-11	CARBON	6.8K 5% 1/4W
R568	1-249-427-11	CARBON	6.8K 5% 1/4W
R569	1-249-426-11	CARBON	5.6K 5% 1/4W
R570	1-249-441-11	CARBON	100K 5% 1/4W
R571	1-249-429-11	CARBON	10K 5% 1/4W
R572	1-249-429-11	CARBON	10K 5% 1/4W
R574	1-249-417-11	CARBON	1K 5% 1/4W
R579	1-249-417-11	CARBON	1K 5% 1/4W
R1401	1-215-445-00	METAL	10K 1% 1/4W
R1402	1-215-445-00	METAL	10K 1% 1/4W
R1403	1-215-445-00	METAL	10K 1% 1/4W
R1404	1-215-445-00	METAL	10K 1% 1/4W
R1405	1-249-385-11	CARBON	2.2 5% 1/4W
R1406	1-249-385-11	CARBON	2.2 5% 1/4W
R1409	1-249-433-11	CARBON	22K 5% 1/4W
R1410	1-249-433-11	CARBON	22K 5% 1/4W
R1411	1-249-437-11	CARBON	47K 5% 1/4W
R1427	A 1-215-865-91	METAL OXIDE	220 5% 1W F
R1428	A 1-215-865-91	METAL OXIDE	220 5% 1W F
R1431	1-247-807-31	CARBON	100 5% 1/4W
R1433	1-249-425-11	CARBON	4.7K 5% 1/4W
R1434	1-249-423-11	CARBON	3.3K 5% 1/4W
R1439	1-247-883-00	CARBON	150K 5% 1/4W
R1440	1-249-417-11	CARBON	1K 5% 1/4W
R1442	1-249-398-11	CARBON	27 5% 1/4W
R1443	1-249-398-11	CARBON	27 5% 1/4W

REF. NO.	PART NO.	DESCRIPTION	REMARK
R1520	1-249-429-11	CARBON	10K 5% 1/4W
R1601	1-249-423-11	CARBON	3.3K 5% 1/4W
R1602	1-249-417-11	CARBON	1K 5% 1/4W
R1603	1-249-423-11	CARBON	3.3K 5% 1/4W
R1604	1-247-807-31	CARBON	100 5% 1/4W
R1605	1-247-807-31	CARBON	100 5% 1/4W
R1606	1-247-807-31	CARBON	100 5% 1/4W
R1607	1-249-415-11	CARBON	680 5% 1/4W
R1608	1-249-415-11	CARBON	680 5% 1/4W
R1609	1-249-415-11	CARBON	680 5% 1/4W
R1610	1-247-807-31	CARBON	100 5% 1/4W
R1611	1-247-807-31	CARBON	100 5% 1/4W
R1612	1-247-807-31	CARBON	100 5% 1/4W
R1613	1-249-423-11	CARBON	3.3K 5% 1/4W
R1614	1-249-411-11	CARBON	330 5% 1/4W
R1622	1-249-423-11	CARBON	3.3K 5% 1/4W
R1624	1-249-424-11	CARBON	3.9K 5% 1/4W
R1627	1-249-429-11	CARBON	10K 5% 1/4W
R1630	1-249-434-11	CARBON	27K 5% 1/4W
R1631	1-249-433-11	CARBON	22K 5% 1/4W
R1656	1-249-397-11	CARBON	22 5% 1/4W
R1657	1-249-397-11	CARBON	22 5% 1/4W
R1658	1-249-397-11	CARBON	22 5% 1/4W
<TRANSFORMER>			
T501	A 1-439-545-11	TRANSFORMER, FERRITE	
T502	A 1-437-078-11	TRANSFORMER, HORIZONTAL DRIVE	
<TUNER>			
TU101	A 1-693-102-21	TUNER (BTF-XA401)	

*A-1346-138-A E1 BOARD, COMPLETE			

<CAPACITOR>			
C301	1-163-010-11	CERAMIC CHIP	0.0012MF 10% 50V
C303	1-126-157-11	ELECT	10MF 20% 16V
C304	1-164-232-11	CERAMIC CHIP	0.01MF 10% 50V
C305	1-163-251-11	CERAMIC CHIP	100PF 5% 50V
C306	1-163-117-00	CERAMIC CHIP	100PF 5% 50V
C309	1-164-505-11	CERAMIC CHIP	2.2MF 16V
C310	1-163-109-00	CERAMIC CHIP	47PF 5% 50V
C314	1-124-667-11	ELECT	10MF 20% 16V
C315	1-164-505-11	CERAMIC CHIP	2.2MF 16V
C319	1-126-157-11	ELECT	10MF 20% 16V
C320	1-124-465-00	ELECT	0.47MF 20% 50V
C321	1-163-125-00	CERAMIC CHIP	220PF 5% 50V
C322	1-163-003-11	CERAMIC CHIP	330PF 10% 50V
C323	1-163-099-00	CERAMIC CHIP	18PF 5% 50V
C324	1-124-234-00	ELECT	22MF 20% 16V
C325	1-104-563-11	FILM CHIP	0.1MF 5% 16V
C326	1-104-563-11	FILM CHIP	0.1MF 5% 16V
C327	1-104-563-11	FILM CHIP	0.1MF 5% 16V
C328	1-126-157-11	ELECT	10MF 20% 16V
C329	1-126-157-11	ELECT	10MF 20% 16V
C330	1-126-157-11	ELECT	10MF 20% 16V
C331	1-126-301-11	ELECT	1MF 20% 50V
C332	1-124-584-00	ELECT	100MF 20% 10V
C333	1-163-037-11	CERAMIC CHIP	0.022MF 10% 25V
C334	1-137-491-11	FILM CHIP	0.1MF 5% 25V

E1

REF. NO.	PART NO.	DESCRIPTION	REMARK	REF. NO.	PART NO.	DESCRIPTION	REMARK
R312	1-216-043-00	METAL GLAZE	560 5% 1/10W	R391	1-216-049-00	METAL GLAZE	1K 5% 1/10W
R313	1-216-035-00	METAL GLAZE	270 5% 1/10W	R393	1-216-051-00	METAL GLAZE	1.2K 5% 1/10W
R314	1-216-061-00	METAL GLAZE	3.3K 5% 1/10W	R394	1-216-109-00	METAL GLAZE	330K 5% 1/10W
R316	1-216-035-00	METAL GLAZE	270 5% 1/10W	R395	1-216-071-00	METAL GLAZE	8.2K 5% 1/10W
R317	1-216-121-00	METAL GLAZE	1M 5% 1/10W	R397	1-216-081-00	METAL GLAZE	22K 5% 1/10W
R320	1-216-039-00	METAL GLAZE	390 5% 1/10W	R398	1-216-081-00	METAL GLAZE	22K 5% 1/10W
R325	1-216-033-00	METAL GLAZE	220 5% 1/10W	R399	1-216-077-00	METAL GLAZE	15K 5% 1/10W
R326	1-216-057-00	METAL GLAZE	2.2K 5% 1/10W	R1301	1-216-049-00	METAL GLAZE	1K 5% 1/10W
R331	1-216-017-00	METAL GLAZE	47 5% 1/10W	R1302	1-216-045-00	METAL GLAZE	680 5% 1/10W
R332	1-216-657-11	METAL CHIP	1.8K 0.50% 1/10W	R1303	1-216-085-00	METAL GLAZE	33K 5% 1/10W
R333	1-216-051-00	METAL GLAZE	1.2K 5% 1/10W	R1304	1-216-081-00	METAL GLAZE	22K 5% 1/10W
R336	1-216-047-00	METAL GLAZE	820 5% 1/10W	R1305	1-216-025-00	METAL GLAZE	100 5% 1/10W
R338	1-216-043-00	METAL GLAZE	560 5% 1/10W	R1306	1-216-057-00	METAL GLAZE	2.2K 5% 1/10W
R339	1-216-047-00	METAL GLAZE	820 5% 1/10W	R1307	1-216-073-00	METAL GLAZE	10K 5% 1/10W
R340	1-216-651-11	METAL CHIP	1K 0.50% 1/10W	R1308	1-216-065-00	METAL GLAZE	4.7K 5% 1/10W
R341	1-216-043-00	METAL GLAZE	560 5% 1/10W	R1309	1-216-025-00	METAL GLAZE	100 5% 1/10W
R343	1-216-077-00	METAL GLAZE	15K 5% 1/10W	R1310	1-216-045-00	METAL GLAZE	680 5% 1/10W
R344	1-216-081-00	METAL GLAZE	22K 5% 1/10W	R1311	1-216-049-00	METAL GLAZE	1K 5% 1/10W
R345	1-216-292-11	METAL GLAZE	8.2K 5% 1/8W	R1312	1-216-073-00	METAL GLAZE	10K 5% 1/10W
R346	1-216-081-00	METAL GLAZE	22K 5% 1/10W	R1313	1-216-081-00	METAL GLAZE	22K 5% 1/10W
R347	1-216-081-00	METAL GLAZE	22K 5% 1/10W	R1314	1-216-065-00	METAL GLAZE	4.7K 5% 1/10W
R348	1-216-049-00	METAL GLAZE	1K 5% 1/10W	R1315	1-216-049-00	METAL GLAZE	1K 5% 1/10W
R349	1-216-295-00	METAL GLAZE	0 5% 1/10W	R1316	1-216-081-00	METAL GLAZE	22K 5% 1/10W
R350	1-216-089-91	METAL GLAZE	47K 5% 1/10W	R1317	1-216-073-00	METAL GLAZE	10K 5% 1/10W
R351	1-216-674-11	METAL CHIP	9.1K 0.50% 1/10W	R1318	1-216-065-00	METAL GLAZE	4.7K 5% 1/10W
R352	1-216-011-00	METAL GLAZE	27 5% 1/10W	R1319	1-216-065-00	METAL GLAZE	4.7K 5% 1/10W
R353	1-216-001-00	METAL GLAZE	10 5% 1/10W	R1320	1-216-063-00	METAL GLAZE	3.9K 5% 1/10W
R354	1-216-049-00	METAL GLAZE	1K 5% 1/10W	R1321	1-216-081-00	METAL GLAZE	22K 5% 1/10W
R355	1-216-001-00	METAL GLAZE	10 5% 1/10W	R1322	1-216-061-00	METAL GLAZE	3.3K 5% 1/10W
R356	1-216-001-00	METAL GLAZE	10 5% 1/10W	R1323	1-216-089-91	METAL GLAZE	47K 5% 1/10W
R357	1-216-049-00	METAL GLAZE	1K 5% 1/10W	R1324	1-216-045-00	METAL GLAZE	680 5% 1/10W
R358	1-216-049-00	METAL GLAZE	1K 5% 1/10W	R1325	1-216-025-00	METAL GLAZE	100 5% 1/10W
R359	1-216-049-00	METAL GLAZE	1K 5% 1/10W	R1326	1-216-073-00	METAL GLAZE	10K 5% 1/10W
R360	1-216-119-00	METAL GLAZE	820K 5% 1/10W	R1327	1-216-033-00	METAL GLAZE	220 5% 1/10W
R361	1-216-025-00	METAL GLAZE	100 5% 1/10W	R1328	1-216-033-00	METAL GLAZE	220 5% 1/10W
R362	1-216-079-00	METAL GLAZE	18K 5% 1/10W	R1329	1-216-077-00	METAL GLAZE	15K 5% 1/10W
R363	1-216-295-00	METAL GLAZE	0 5% 1/10W	R1330	1-216-081-00	METAL GLAZE	22K 5% 1/10W
R364	1-216-045-00	METAL GLAZE	680 5% 1/10W	R1331	1-216-081-00	METAL GLAZE	22K 5% 1/10W
R365	1-216-017-00	METAL GLAZE	47 5% 1/10W	R1333	1-216-129-00	METAL GLAZE	2.2M 5% 1/10W
R366	1-216-001-00	METAL GLAZE	10 5% 1/10W	R1342	1-216-033-00	METAL GLAZE	220 5% 1/10W
R367	1-216-045-00	METAL GLAZE	680 5% 1/10W	R1346	1-216-049-00	METAL GLAZE	1K 5% 1/10W
R368	1-216-001-00	METAL GLAZE	10 5% 1/10W	R1347	1-216-049-00	METAL GLAZE	1K 5% 1/10W
R369	1-216-033-00	METAL GLAZE	220 5% 1/10W	R1348	1-216-049-00	METAL GLAZE	1K 5% 1/10W
R370	1-216-033-00	METAL GLAZE	220 5% 1/10W	R1349	1-216-073-00	METAL GLAZE	10K 5% 1/10W
R371	1-216-033-00	METAL GLAZE	220 5% 1/10W	R1350	1-216-091-00	METAL GLAZE	56K 5% 1/10W
R372	1-216-031-00	METAL GLAZE	180 5% 1/10W	R1352	1-216-039-00	METAL GLAZE	390 5% 1/10W
R373	1-216-671-11	METAL CHIP	6.8K 0.50% 1/10W	R1353	1-216-053-00	METAL GLAZE	1.5K 5% 1/10W
R374	1-216-037-00	METAL GLAZE	330 5% 1/10W	R1354	1-216-081-00	METAL GLAZE	22K 5% 1/10W
R375	1-216-037-00	METAL GLAZE	330 5% 1/10W	R1355	1-216-017-00	METAL GLAZE	47 5% 1/10W
R376	1-216-037-00	METAL GLAZE	330 5% 1/10W	R1356	1-216-057-00	METAL GLAZE	2.2K 5% 1/10W
R377	1-216-033-00	METAL GLAZE	220 5% 1/10W	R1357	1-216-081-00	METAL GLAZE	22K 5% 1/10W
R378	1-216-033-00	METAL GLAZE	220 5% 1/10W	R1358	1-216-033-00	METAL GLAZE	220 5% 1/10W
R379	1-216-033-00	METAL GLAZE	220 5% 1/10W	R1362	1-216-105-00	METAL GLAZE	220K 5% 1/10W
R380	1-216-033-00	METAL GLAZE	220 5% 1/10W	R1363	1-216-041-00	METAL GLAZE	470 5% 1/10W
R381	1-216-033-00	METAL GLAZE	220 5% 1/10W	R1364	1-216-053-00	METAL GLAZE	1.5K 5% 1/10W
R382	1-216-033-00	METAL GLAZE	220 5% 1/10W	R1373	1-216-049-00	METAL GLAZE	1K 5% 1/10W
R383	1-216-653-11	METAL CHIP	1.2K 0.50% 1/10W	R1374	1-216-025-00	METAL GLAZE	100 5% 1/10W
R384	1-216-041-00	METAL GLAZE	470 5% 1/10W	R1379	1-216-079-00	METAL GLAZE	18K 5% 1/10W
R385	1-216-081-00	METAL GLAZE	22K 5% 1/10W	R1380	1-216-075-00	METAL GLAZE	12K 5% 1/10W
R386	1-216-687-11	METAL CHIP	33K 0.50% 1/10W	R1381	1-216-041-00	METAL GLAZE	470 5% 1/10W
R387	1-216-033-00	METAL GLAZE	220 5% 1/10W	R1382	1-216-079-00	METAL GLAZE	18K 5% 1/10W
R388	1-216-033-00	METAL GLAZE	220 5% 1/10W	R1383	1-216-077-00	METAL GLAZE	15K 5% 1/10W
R389	1-216-081-00	METAL GLAZE	22K 5% 1/10W	R1384	1-216-049-00	METAL GLAZE	1K 5% 1/10W
R390	1-216-033-00	METAL GLAZE	220 5% 1/10W				

E1 E2

REF. NO.	PART NO.	DESCRIPTION	REMARK	REF. NO.	PART NO.	DESCRIPTION	REMARK
R1385	1-216-037-00	METAL GLAZE 330 5%	1/10W	C2353	1-164-232-11	CERAMIC CHIP 0.01MF	10% 50V
R1386	1-216-037-00	METAL GLAZE 330 5%	1/10W	C2354	1-164-232-11	CERAMIC CHIP 0.01MF	10% 50V
R1387	1-216-045-00	METAL GLAZE 680 5%	1/10W	C2357	1-126-301-11	ELECT 1MF	20% 50V
R1388	1-216-001-00	METAL GLAZE 10 5%	1/10W	C2360	1-163-109-00	CERAMIC CHIP 47PF	5% 50V
R1389	1-216-097-00	METAL GLAZE 100K 5%	1/10W			<DIODE>	
R1390	1-216-097-00	METAL GLAZE 100K 5%	1/10W	D2306	8-719-404-46	DIODE MA110	
R1391	1-216-097-00	METAL GLAZE 100K 5%	1/10W	D2307	8-719-948-98	DIODE FMN1	
R1392	1-216-081-00	METAL GLAZE 22K 5%	1/10W	D2308	8-719-948-98	DIODE FMN1	
R1394	1-216-081-00	METAL GLAZE 22K 5%	1/10W	D2309	8-719-404-46	DIODE MA110	
R1395	1-216-081-00	METAL GLAZE 22K 5%	1/10W	D2312	8-719-404-46	DIODE MA110	
R1396	1-216-125-00	METAL GLAZE 1.5M 5%	1/10W	D2313	8-719-404-46	DIODE MA110	
R1399	1-216-065-00	METAL GLAZE 4.7K 5%	1/10W	D2314	8-713-300-57	DIODE 1T33	
R5301	1-216-057-00	METAL GLAZE 2.2K 5%	1/10W	D2317	8-719-404-46	DIODE MA110	
R5302	1-216-073-00	METAL GLAZE 10K 5%	1/10W			<CONNECTOR>	
R5303	1-216-073-00	METAL GLAZE 10K 5%	1/10W	E2-25	*1-564-521-11	PLUG, CONNECTOR 6P	
R5304	1-216-085-00	METAL GLAZE 33K 5%	1/10W	E2-26	*1-564-522-11	PLUG, CONNECTOR 7P	
R5305	1-216-085-00	METAL GLAZE 33K 5%	1/10W	E2-46	*1-564-518-11	PLUG, CONNECTOR 3P	
		<CRYSTAL>		E2-002	*1-573-965-21	PIN, CONNECTOR (PC BOARD) 50P	
X301	1-567-505-11	OSCILLATOR, CRYSTAL				<IC>	

	*A-1346-136-A	E2 BOARD, COMPLETE		IC2301	8-759-066-52	IC PCA8510T/012-T	
		*****		IC2303	8-759-925-75	IC SN74HC05ANS	
		<CAPACITOR>		IC2304	8-752-037-15	IC CXA1387S	
C2302	1-163-009-11	CERAMIC CHIP 0.001MF	10% 50V	IC2306	8-759-011-65	IC MC74HC4053F	
C2303	1-164-232-11	CERAMIC CHIP 0.01MF	10% 50V	IC2307	8-752-058-68	IC CXA1315M	
C2310	1-163-105-00	CERAMIC CHIP 33PF	5% 50V			<COIL>	
C2313	1-163-133-00	CERAMIC CHIP 470PF	5% 50V	L2304	1-408-414-00	INDUCTOR 27UH	
C2314	1-164-232-11	CERAMIC CHIP 0.01MF	10% 50V			<TRANSISTOR>	
C2315	1-126-157-11	ELECT 10MF	20% 16V	Q2301	8-729-903-10	TRANSISTOR FMW1	
C2316	1-126-157-11	ELECT 10MF	20% 16V	Q2303	8-729-403-27	TRANSISTOR XN4401	
C2317	1-126-157-11	ELECT 10MF	20% 16V	Q2304	8-729-925-79	TRANSISTOR IMX3	
C2318	1-164-232-11	CERAMIC CHIP 0.01MF	10% 50V	Q2305	8-729-903-10	TRANSISTOR FMW1	
C2320	1-124-589-11	ELECT 47MF	20% 16V	Q2306	8-729-403-27	TRANSISTOR XN4401	
C2321	1-163-017-00	CERAMIC CHIP 0.0047MF	10% 50V	Q2307	8-729-403-27	TRANSISTOR XN4401	
C2322	1-124-234-00	ELECT 22MF	20% 16V	Q2308	8-729-403-27	TRANSISTOR XN4401	
C2323	1-124-234-00	ELECT 22MF	20% 16V	Q2309	8-729-903-10	TRANSISTOR FMW1	
C2324	1-124-234-00	ELECT 22MF	20% 16V	Q2310	8-729-403-27	TRANSISTOR XN4401	
C2325	1-164-232-11	CERAMIC CHIP 0.01MF	10% 50V	Q2311	8-729-903-10	TRANSISTOR FMW1	
C2326	1-124-589-11	ELECT 47MF	20% 16V	Q2312	8-729-403-27	TRANSISTOR XN4401	
C2327	1-164-505-11	CERAMIC CHIP 2.2MF	10% 50V	Q2313	8-729-903-10	TRANSISTOR FMW1	
C2328	1-164-232-11	CERAMIC CHIP 0.01MF	10% 50V	Q2314	8-729-403-27	TRANSISTOR XN4401	
C2329	1-164-232-11	CERAMIC CHIP 0.01MF	10% 50V	Q2315	8-729-903-10	TRANSISTOR FMW1	
C2331	1-164-232-11	CERAMIC CHIP 0.01MF	10% 50V	Q2317	8-729-216-22	TRANSISTOR 2SA1162-G	
C2332	1-124-234-00	ELECT 22MF	20% 16V	Q2318	8-729-216-22	TRANSISTOR 2SA1162-G	
C2333	1-124-234-00	ELECT 22MF	20% 16V	Q2319	8-729-216-22	TRANSISTOR 2SA1162-G	
C2334	1-164-232-11	CERAMIC CHIP 0.01MF	10% 50V	Q2320	8-729-120-28	TRANSISTOR 2SC1623-L5L6	
C2335	1-164-232-11	CERAMIC CHIP 0.01MF	10% 50V	Q2321	8-729-120-28	TRANSISTOR 2SC1623-L5L6	
C2336	1-126-163-11	ELECT 4.7MF	20% 16V	Q2322	8-729-120-28	TRANSISTOR 2SC1623-L5L6	
C2337	1-164-232-11	CERAMIC CHIP 0.01MF	10% 50V	Q2324	8-729-216-22	TRANSISTOR 2SA1162-G	
C2338	1-163-038-00	CERAMIC CHIP 0.1MF	25V	Q2326	8-729-120-28	TRANSISTOR 2SC1623-L5L6	
C2340	1-163-251-11	CERAMIC CHIP 100PF	5% 50V	Q2327	8-729-120-28	TRANSISTOR 2SC1623-L5L6	
C2345	1-164-505-11	CERAMIC CHIP 2.2MF	16V	Q2330	8-729-903-10	TRANSISTOR FMW1	
C2346	1-164-232-11	CERAMIC CHIP 0.01MF	10% 50V	Q2337	8-729-925-79	TRANSISTOR IMX3	
C2347	1-163-367-11	CERAMIC CHIP 39PF	5% 50V	Q2338	8-729-120-28	TRANSISTOR 2SC1623-L5L6	
C2349	1-164-505-11	CERAMIC CHIP 2.2MF	16V	Q2339	8-729-120-28	TRANSISTOR 2SC1623-L5L6	
C2350	1-164-232-11	CERAMIC CHIP 0.01MF	10% 50V	Q2340	8-729-120-28	TRANSISTOR 2SC1623-L5L6	
C2351	1-164-505-11	CERAMIC CHIP 2.2MF	16V				
C2352	1-164-505-11	CERAMIC CHIP 2.2MF	16V				

E2

REF. NO.	PART NO.	DESCRIPTION	REMARK	REF. NO.	PART NO.	DESCRIPTION	REMARK
Q2341	8-729-120-28	TRANSISTOR 2SC1623-L5L6		R2365	1-216-053-00	METAL GLAZE 1.5K 5%	1/10W
Q2342	8-729-120-28	TRANSISTOR 2SC1623-L5L6		R2366	1-216-081-00	METAL GLAZE 22K 5%	1/10W
Q2345	8-729-120-28	TRANSISTOR 2SC1623-L5L6					
<RESISTOR>							
R2302	1-216-049-00	METAL GLAZE 1K 5%	1/10W	R2367	1-216-043-00	METAL GLAZE 560 5%	1/10W
R2303	1-216-049-00	METAL GLAZE 1K 5%	1/10W	R2368	1-216-081-00	METAL GLAZE 22K 5%	1/10W
R2304	1-216-049-00	METAL GLAZE 1K 5%	1/10W	R2371	1-216-033-00	METAL GLAZE 220 5%	1/10W
R2305	1-216-033-00	METAL GLAZE 220 5%	1/10W	R2374	1-216-067-00	METAL GLAZE 5.6K 5%	1/10W
R2306	1-216-045-00	METAL GLAZE 680 5%	1/10W	R2375	1-216-081-00	METAL GLAZE 22K 5%	1/10W
R2307	1-216-045-00	METAL GLAZE 680 5%	1/10W	R2376	1-216-081-00	METAL GLAZE 22K 5%	1/10W
R2308	1-216-045-00	METAL GLAZE 680 5%	1/10W	R2377	1-216-025-00	METAL GLAZE 100 5%	1/10W
R2309	1-216-041-00	METAL GLAZE 470 5%	1/10W	R2378	1-216-025-00	METAL GLAZE 100 5%	1/10W
R2310	1-216-055-00	METAL GLAZE 1.8K 5%	1/10W	R2379	1-216-043-00	METAL GLAZE 560 5%	1/10W
R2311	1-216-025-00	METAL GLAZE 100 5%	1/10W	R2380	1-216-043-00	METAL GLAZE 560 5%	1/10W
R2312	1-216-043-00	METAL GLAZE 560 5%	1/10W	R2381	1-216-043-00	METAL GLAZE 560 5%	1/10W
R2313	1-216-055-00	METAL GLAZE 1.8K 5%	1/10W	R2382	1-216-073-00	METAL GLAZE 10K 5%	1/10W
R2314	1-216-061-00	METAL GLAZE 3.3K 5%	1/10W	R2384	1-216-081-00	METAL GLAZE 22K 5%	1/10W
R2315	1-216-081-00	METAL GLAZE 22K 5%	1/10W	R2385	1-216-075-00	METAL GLAZE 12K 5%	1/10W
R2317	1-216-041-00	METAL GLAZE 470 5%	1/10W	R2386	1-216-049-00	METAL GLAZE 1K 5%	1/10W
R2318	1-216-055-00	METAL GLAZE 1.8K 5%	1/10W	R2387	1-216-025-00	METAL GLAZE 100 5%	1/10W
R2319	1-216-079-00	METAL GLAZE 18K 5%	1/10W	R2388	1-216-017-00	METAL GLAZE 47 5%	1/10W
R2320	1-216-061-00	METAL GLAZE 3.3K 5%	1/10W	R2390	1-216-043-00	METAL GLAZE 560 5%	1/10W
R2321	1-216-063-00	METAL GLAZE 3.9K 5%	1/10W	R2393	1-216-017-00	METAL GLAZE 47 5%	1/10W
R2322	1-216-049-00	METAL GLAZE 1K 5%	1/10W	R2394	1-216-049-00	METAL GLAZE 1K 5%	1/10W
R2323	1-216-067-00	METAL GLAZE 5.6K 5%	1/10W	R2395	1-216-001-00	METAL GLAZE 10 5%	1/10W
R2324	1-216-049-00	METAL GLAZE 1K 5%	1/10W	R2397	1-216-043-00	METAL GLAZE 560 5%	1/10W
R2325	1-216-049-00	METAL GLAZE 1K 5%	1/10W	R2399	1-216-001-00	METAL GLAZE 10 5%	1/10W
R2326	1-216-061-00	METAL GLAZE 3.3K 5%	1/10W	R3301	1-216-049-00	METAL GLAZE 1K 5%	1/10W
R2327	1-216-063-00	METAL GLAZE 3.9K 5%	1/10W	R3302	1-216-001-00	METAL GLAZE 10 5%	1/10W
R2328	1-216-025-00	METAL GLAZE 100 5%	1/10W	R3303	1-216-069-00	METAL GLAZE 6.8K 5%	1/10W
R2329	1-216-025-00	METAL GLAZE 100 5%	1/10W	R3304	1-216-091-00	METAL GLAZE 56K 5%	1/10W
R2330	1-216-061-00	METAL GLAZE 3.3K 5%	1/10W	R3306	1-216-089-91	METAL GLAZE 47K 5%	1/10W
R2331	1-216-063-00	METAL GLAZE 3.9K 5%	1/10W	R3307	1-216-085-00	METAL GLAZE 33K 5%	1/10W
R2332	1-216-025-00	METAL GLAZE 100 5%	1/10W	R3308	1-216-043-00	METAL GLAZE 560 5%	1/10W
R2333	1-216-067-00	METAL GLAZE 5.6K 5%	1/10W	R3309	1-216-049-00	METAL GLAZE 1K 5%	1/10W
R2334	1-216-295-00	METAL GLAZE 0 5%	1/10W	R3310	1-216-001-00	METAL GLAZE 10 5%	1/10W
R2335	1-216-295-00	METAL GLAZE 0 5%	1/10W	R3311	1-216-081-00	METAL GLAZE 22K 5%	1/10W
R2336	1-216-295-00	METAL GLAZE 0 5%	1/10W	R3312	1-216-049-00	METAL GLAZE 1K 5%	1/10W
R2337	1-216-033-00	METAL GLAZE 220 5%	1/10W	R3313	1-216-083-00	METAL GLAZE 27K 5%	1/10W
R2338	1-216-081-00	METAL GLAZE 22K 5%	1/10W	R3314	1-216-689-11	METAL GLAZE 39K 5%	1/10W
R2340	1-216-049-00	METAL GLAZE 1K 5%	1/10W	R3315	1-216-077-00	METAL GLAZE 15K 5%	1/10W
R2341	1-216-041-00	METAL GLAZE 470 5%	1/10W	R3316	1-216-077-00	METAL GLAZE 15K 5%	1/10W
R2342	1-216-049-00	METAL GLAZE 1K 5%	1/10W	R3318	1-216-091-00	METAL GLAZE 56K 5%	1/10W
R2343	1-216-049-00	METAL GLAZE 1K 5%	1/10W	R3319	1-216-081-00	METAL GLAZE 22K 5%	1/10W
R2344	1-216-033-00	METAL GLAZE 220 5%	1/10W	R3320	1-216-017-00	METAL GLAZE 47 5%	1/10W
R2345	1-216-077-00	METAL GLAZE 15K 5%	1/10W	R3321	1-216-079-00	METAL GLAZE 18K 5%	1/10W
R2346	1-216-049-00	METAL GLAZE 1K 5%	1/10W	R3323	1-216-091-00	METAL GLAZE 56K 5%	1/10W
R2347	1-216-083-00	METAL GLAZE 27K 5%	1/10W	R3324	1-216-049-00	METAL GLAZE 1K 5%	1/10W
R2350	1-216-073-00	METAL GLAZE 10K 5%	1/10W	R3325	1-216-025-00	METAL GLAZE 100 5%	1/10W
R2351	1-216-033-00	METAL GLAZE 220 5%	1/10W	R3328	1-216-001-00	METAL GLAZE 10 5%	1/10W
R2352	1-216-073-00	METAL GLAZE 10K 5%	1/10W	R3330	1-216-033-00	METAL GLAZE 220 5%	1/10W
R2353	1-216-073-00	METAL GLAZE 10K 5%	1/10W	R3331	1-216-033-00	METAL GLAZE 220 5%	1/10W
R2354	1-216-210-00	METAL GLAZE 3.3K 5%	1/8W	R3332	1-216-081-00	METAL GLAZE 22K 5%	1/10W
R2355	1-216-178-00	METAL GLAZE 150 5%	1/8W	R3339	1-216-081-00	METAL GLAZE 22K 5%	1/10W
R2356	1-216-677-11	METAL CHIP 12K 0.50%	1/10W	R3340	1-216-073-00	METAL GLAZE 10K 5%	1/10W
R2357	1-216-670-11	METAL CHIP 6.2K 0.50%	1/10W	R3341	1-216-677-11	METAL CHIP 12K 0.50%	1/10W
R2359	1-216-053-00	METAL GLAZE 1.5K 5%	1/10W	R3342	1-216-670-11	METAL CHIP 6.2K 0.50%	1/10W
R2360	1-216-053-00	METAL GLAZE 1.5K 5%	1/10W	R3343	1-216-073-00	METAL GLAZE 10K 5%	1/10W
R2361	1-216-053-00	METAL GLAZE 1.5K 5%	1/10W	R3344	1-216-073-00	METAL GLAZE 10K 5%	1/10W
R2362	1-216-053-00	METAL GLAZE 1.5K 5%	1/10W	R3349	1-216-073-00	METAL GLAZE 10K 5%	1/10W
R2363	1-216-041-00	METAL GLAZE 470 5%	1/10W	R3350	1-216-065-00	METAL GLAZE 4.7K 5%	1/10W
R2364	1-216-053-00	METAL GLAZE 1.5K 5%	1/10W	R3351	1-216-065-00	METAL GLAZE 4.7K 5%	1/10W
				R3353	1-216-059-00	METAL GLAZE 2.7K 5%	1/10W
				R3354	1-216-059-00	METAL GLAZE 2.7K 5%	1/10W
				R3361	1-216-049-00	METAL GLAZE 1K 5%	1/10W

E2

M

REF. NO.	PART NO.	DESCRIPTION	REMARK	REF. NO.	PART NO.	DESCRIPTION	REMARK
R3362	1-216-073-00	METAL GLAZE 10K 5%	1/10W				
R3364	1-216-295-00	METAL GLAZE 0 5%	1/10W				
R3365	1-216-097-00	METAL GLAZE 100K 5%	1/10W				
R3367	1-216-077-00	METAL GLAZE 15K 5%	1/10W				
R3368	1-216-083-00	METAL GLAZE 27K 5%	1/10W				
R3369	1-216-001-00	METAL GLAZE 10 5%	1/10W				
R3370	1-216-001-00	METAL GLAZE 10 5%	1/10W				
R3371	1-216-001-00	METAL GLAZE 10 5%	1/10W				
R3374	1-216-059-00	METAL GLAZE 2.7K 5%	1/10W				
R3392	1-216-089-91	METAL GLAZE 47K 5%	1/10W				
R3401	1-216-057-00	METAL GLAZE 2.2K 5%	1/10W				
R7312	1-216-049-00	METAL GLAZE 1K 5%	1/10W				
R7313	1-216-047-00	METAL GLAZE 820 5%	1/10W				
R7314	1-216-057-00	METAL GLAZE 2.2K 5%	1/10W				
<CRYSTAL>							
X2301	1-577-071-11	VIBRATOR, CERAMIC					

	*A-1306-435-A	M BOARD, COMPLETE					

<CAPACITOR>							
C001	1-124-261-00	ELECT 10MF	20%	50V			
C002	1-163-125-00	CERAMIC CHIP 220PF	5%	50V			
C003	1-136-161-00	FILM 0.047MF	5%	50V			
C004	1-126-301-11	ELECT 1MF	20%	50V			
C005	1-163-125-00	CERAMIC CHIP 220PF	5%	50V			
C014	1-124-910-11	ELECT 47MF	20%	50V			
C015	1-124-464-11	ELECT 0.22MF	20%	50V			
C017	1-124-589-11	ELECT 47MF	20%	16V			
C018	1-163-141-00	CERAMIC CHIP 0.001MF	5%	50V			
C019	1-164-695-11	CERAMIC CHIP 0.0022MF	5%	50V			
C020	1-163-241-11	CERAMIC CHIP 39PF	5%	50V			
C021	1-163-239-11	CERAMIC CHIP 33PF	5%	50V			
C029	1-163-249-11	CERAMIC CHIP 82PF	5%	50V			
C030	1-163-249-11	CERAMIC CHIP 82PF	5%	50V			
C034	1-163-125-00	CERAMIC CHIP 220PF	5%	50V			
C035	1-163-125-00	CERAMIC CHIP 220PF	5%	50V			
C036	1-163-125-00	CERAMIC CHIP 220PF	5%	50V			
C041	1-163-117-00	CERAMIC CHIP 100PF	5%	50V			
C042	1-163-117-00	CERAMIC CHIP 100PF	5%	50V			
C045	1-163-125-00	CERAMIC CHIP 220PF	5%	50V			
C047	1-124-261-00	ELECT 10MF	20%	50V			
C048	1-124-261-00	ELECT 10MF	20%	50V			
C049	1-124-261-00	ELECT 10MF	20%	50V			
C055	1-163-809-11	CERAMIC CHIP 0.047MF	10%	25V			
C064	1-163-121-00	CERAMIC CHIP 150PF	5%	50V			
C065	1-124-257-00	ELECT 2.2MF	20%	50V			
<DIODE>							
D001	8-719-404-46	DIODE MA110					
D002	8-719-404-46	DIODE MA110					
D003	8-719-404-46	DIODE MA110					
D004	8-719-404-46	DIODE MA110					
D005	8-719-404-46	DIODE MA110					
D006	8-719-404-46	DIODE MA110					
D007	8-719-404-46	DIODE MA110					
D008	8-719-404-46	DIODE MA110					
D009	8-719-404-46	DIODE MA110					
D010	8-713-300-57	DIODE 1T33					
D011	8-719-404-46	DIODE MA110					
D012	8-719-404-46	DIODE MA110					
D014	8-719-404-46	DIODE MA110					
D015	8-719-404-46	DIODE MA110					
<IC>							
IC001	8-759-194-83	IC TMC73C247-11					
IC002	8-759-403-44	IC MN1280-S					
<COIL>							
L001	1-408-409-00	INDUCTOR 10UH					
L002	1-410-476-11	INDUCTOR 33UH					
<CONNECTOR>							
M-39	*1-564-521-11	PLUG, CONNECTOR 6P					
M-45	1-564-523-11	PLUG, CONNECTOR 8P					
M-001	1-573-965-21	PIN, CONNECTOR (PC BOARD) 50P					
<TRANSISTOR>							
Q001	8-729-216-22	TRANSISTOR 2SA1162-G					
Q002	8-729-216-22	TRANSISTOR 2SA1162-G					
Q003	8-729-216-22	TRANSISTOR 2SA1162-G					
Q004	8-729-120-28	TRANSISTOR 2SC1623-L5L6					
Q005	8-729-120-28	TRANSISTOR 2SC1623-L5L6					
Q006	8-729-216-22	TRANSISTOR 2SA1162-G					
Q007	8-729-216-22	TRANSISTOR 2SA1162-G					
Q008	8-729-120-28	TRANSISTOR 2SC1623-L5L6					
Q009	8-729-120-28	TRANSISTOR 2SC1623-L5L6					
Q010	8-729-120-28	TRANSISTOR 2SC1623-L5L6					
Q011	8-729-120-28	TRANSISTOR 2SC1623-L5L6					
Q012	8-729-120-28	TRANSISTOR 2SC1623-L5L6					
Q013	8-729-216-22	TRANSISTOR 2SA1162-G					
Q014	8-729-120-28	TRANSISTOR 2SC1623-L5L6					
<RESISTOR>							
R001	1-216-045-00	METAL GLAZE 680 5%	1/10W				
R002	1-216-097-00	METAL GLAZE 100K 5%	1/10W				
R003	1-216-121-00	METAL GLAZE 1M 5%	1/10W				
R004	1-216-073-00	METAL GLAZE 10K 5%	1/10W				
R005	1-216-073-00	METAL GLAZE 10K 5%	1/10W				
R006	1-216-065-00	METAL GLAZE 4.7K 5%	1/10W				
R007	1-216-027-00	METAL GLAZE 120 5%	1/10W				
R008	1-216-041-00	METAL GLAZE 470 5%	1/10W				
R009	1-216-027-00	METAL GLAZE 120 5%	1/10W				
R011	1-216-033-00	METAL GLAZE 220 5%	1/10W				
R012	1-216-033-00	METAL GLAZE 220 5%	1/10W				
R013	1-216-067-00	METAL GLAZE 5.6K 5%	1/10W				
R014	1-216-057-00	METAL GLAZE 2.2K 5%	1/10W				
R015	1-216-089-91	METAL GLAZE 47K 5%	1/10W				
R016	1-216-067-00	METAL GLAZE 5.6K 5%	1/10W				
R017	1-216-067-00	METAL GLAZE 5.6K 5%	1/10W				
R018	1-216-065-00	METAL GLAZE 4.7K 5%	1/10W				
R019	1-216-073-00	METAL GLAZE 10K 5%	1/10W				
R020	1-216-065-00	METAL GLAZE 4.7K 5%	1/10W				
R021	1-216-097-00	METAL GLAZE 100K 5%	1/10W				
R022	1-216-089-91	METAL GLAZE 47K 5%	1/10W				
R023	1-216-093-00	METAL GLAZE 68K 5%	1/10W				
R024	1-216-065-00	METAL GLAZE 4.7K 5%	1/10W				
R025	1-216-073-00	METAL GLAZE 10K 5%	1/10W				

REF. NO.	PART NO.	DESCRIPTION	REMARK	REF. NO.	PART NO.	DESCRIPTION	REMARK
C3040	1-164-232-11	CERAMIC CHIP 0.01MF	10%				
C3041	1-124-034-51	ELECT 33MF	20%				
C3042	1-130-491-00	MYLAR 0.047MF	5%				
C3043	1-124-465-00	ELECT 0.47MF	20%				
C3044	1-164-232-11	CERAMIC CHIP 0.01MF	10%				
C3045	1-164-232-11	CERAMIC CHIP 0.01MF	10%				
C3046	1-126-177-11	ELECT 100MF	20%				
C3047	1-164-232-11	CERAMIC CHIP 0.01MF	10%				
C3049	1-164-232-11	CERAMIC CHIP 0.01MF	10%				
C3050	1-164-232-11	CERAMIC CHIP 0.01MF	10%				
C3051	1-124-034-51	ELECT 33MF	20%				
C3052	1-126-101-11	ELECT 100MF	20%				
C3054	1-124-261-00	ELECT 10MF	20%				
C3057	1-124-478-11	ELECT 100MF	20%				
C3058	1-124-478-11	ELECT 100MF	20%				
<NETWORK>							
CP3001	1-236-176-11	NETWORK, RES, THICK FILM					
CP3002	1-236-176-11	NETWORK, RES, THICK FILM					
CP3003	1-236-176-11	NETWORK, RES, THICK FILM					
<DIODE>							
D3002	8-713-300-57	DIODE 1T33					
D3003	8-713-300-57	DIODE 1T33					
D3004	8-719-404-46	DIODE MA110					
<FILTER>							
FL3001	1-236-129-11	ENCAPSULATED COMPONENT					
FL3002	1-236-129-11	ENCAPSULATED COMPONENT					
FL3003	1-236-129-11	ENCAPSULATED COMPONENT					
FL3004	1-236-071-11	ENCAPSULATED COMPONENT					
FL3005	1-236-071-11	ENCAPSULATED COMPONENT					
FL3006	1-236-129-11	ENCAPSULATED COMPONENT					
FL3007	1-236-164-11	ENCAPSULATED COMPONENT					
FL3008	1-236-163-11	ENCAPSULATED COMPONENT					
FL3009	1-236-164-11	ENCAPSULATED COMPONENT					
FL3010	1-236-129-11	ENCAPSULATED COMPONENT					
FL3011	1-236-163-11	ENCAPSULATED COMPONENT					
FL3012	1-236-163-11	ENCAPSULATED COMPONENT					
FL3013	1-236-163-11	ENCAPSULATED COMPONENT					
FL3014	1-236-129-11	ENCAPSULATED COMPONENT					
<IC>							
IC3001	8-759-032-11	IC MC74HC04AF					
IC3002	8-759-032-11	IC MC74HC04AF					
IC3003	8-752-332-83	IC CXD1220AQ					
IC3004	8-759-605-15	IC M5M4C500L-10					
IC3005	8-759-605-14	IC M52678P					
IC3006	8-759-605-15	IC M5M4C500L-10					
IC3007	8-759-011-65	IC MC74HC4053F					
IC3008	8-759-605-15	IC M5M4C500L-10					
IC3009	8-759-605-14	IC M52678P					
IC3010	8-759-112-06	IC UPC78N05H					
IC3011	8-759-049-49	IC UPC7893AHF					
<JACK>							
J3001	1-573-965-21	PIN, CONNECTOR (PC BOARD) 50P					
<COIL>							
L3001	1-410-470-11	INDUCTOR	10UH				
L3002	1-410-470-11	INDUCTOR	10UH				
L3003	1-410-470-11	INDUCTOR	10UH				
L3004	1-410-470-11	INDUCTOR	10UH				
L3005	1-408-420-00	INDUCTOR	82UH				
L3006	1-408-421-00	INDUCTOR	100UH				
L3007	1-410-434-21	INDUCTOR	180UH				
L3008	1-408-427-00	INDUCTOR	330UH				
<CONNECTOR>							
P2-40	*1-564-519-11	PLUG, CONNECTOR 4P					
<TRANSISTOR>							
Q3001	8-729-120-28	TRANSISTOR 2SC1623-L5L6					
Q3002	8-729-120-28	TRANSISTOR 2SC1623-L5L6					
Q3003	8-729-216-22	TRANSISTOR 2SA1162-G					
Q3004	8-729-120-28	TRANSISTOR 2SC1623-L5L6					
Q3005	8-729-216-22	TRANSISTOR 2SA1162-G					
Q3006	8-729-216-22	TRANSISTOR 2SA1162-G					
Q3007	8-729-216-22	TRANSISTOR 2SA1162-G					
Q3008	8-729-216-22	TRANSISTOR 2SA1162-G					
Q3009	8-729-120-28	TRANSISTOR 2SC1623-L5L6					
Q3010	8-729-120-28	TRANSISTOR 2SC1623-L5L6					
Q3011	8-729-120-28	TRANSISTOR 2SC1623-L5L6					
Q3012	8-729-120-28	TRANSISTOR 2SC1623-L5L6					
Q3013	8-729-120-28	TRANSISTOR 2SC1623-L5L6					
Q3014	8-729-120-28	TRANSISTOR 2SC1623-L5L6					
Q3015	8-729-120-28	TRANSISTOR 2SC1623-L5L6					
<RESISTOR>							
R3001	1-216-073-00	METAL GLAZE	10K 5%	1/10W			
R3002	1-216-097-00	METAL GLAZE	100K 5%	1/10W			
R3003	1-216-073-00	METAL GLAZE	10K 5%	1/10W			
R3005	1-216-057-00	METAL GLAZE	2.2K 5%	1/10W			
R3006	1-216-049-00	METAL GLAZE	1K 5%	1/10W			
R3007	1-216-049-00	METAL GLAZE	1K 5%	1/10W			
R3008	1-216-049-00	METAL GLAZE	1K 5%	1/10W			
R3009	1-216-049-00	METAL GLAZE	1K 5%	1/10W			
R3010	1-216-049-00	METAL GLAZE	1K 5%	1/10W			
R3011	1-216-049-00	METAL GLAZE	1K 5%	1/10W			
R3012	1-216-093-00	METAL GLAZE	68K 5%	1/10W			
R3013	1-216-097-00	METAL GLAZE	100K 5%	1/10W			
R3014	1-216-091-00	METAL GLAZE	56K 5%	1/10W			
R3015	1-216-097-00	METAL GLAZE	100K 5%	1/10W			
R3016	1-216-093-00	METAL GLAZE	68K 5%	1/10W			
R3017	1-216-077-00	METAL GLAZE	15K 5%	1/10W			
R3018	1-216-091-00	METAL GLAZE	56K 5%	1/10W			
R3019	1-216-049-00	METAL GLAZE	1K 5%	1/10W			
R3020	1-216-017-00	METAL GLAZE	47 5%	1/10W			
R3021	1-216-057-00	METAL GLAZE	2.2K 5%	1/10W			
R3022	1-216-049-00	METAL GLAZE	1K 5%	1/10W			
R3024	1-216-049-00	METAL GLAZE	1K 5%	1/10W			
R3025	1-216-033-00	METAL GLAZE	220 5%	1/10W			
R3026	1-216-049-00	METAL GLAZE	1K 5%	1/10W			
R3027	1-216-053-00	METAL GLAZE	1.5K 5%	1/10W			
R3028	1-216-033-00	METAL GLAZE	220 5%	1/10W			
R3029	1-216-033-00	METAL GLAZE	220 5%	1/10W			
R3030	1-216-043-00	METAL GLAZE	560 5%	1/10W			
R3031	1-216-043-00	METAL GLAZE	560 5%	1/10W			
R3032	1-216-077-00	METAL GLAZE	15K 5%	1/10W			

P2

X3

Les composants identifiés par une trame et par une marque Δ sont d'une importance critique pour la sécurité. Ne les remplacer que par des pièces de numéro spécifié.

The components identified by shading and mark Δ are critical for safety. Replace only with part number specified.

REF. NO.	PART NO.	DESCRIPTION	REMARK	REF. NO.	PART NO.	DESCRIPTION	REMARK
R3033	1-216-053-00	METAL GLAZE	1.5K 5% 1/10W				
R3034	1-216-033-00	METAL GLAZE	220 5% 1/10W				
R3035	1-216-061-00	METAL GLAZE	3.3K 5% 1/10W				
R3036	1-216-049-00	METAL GLAZE	1K 5% 1/10W				
R3037	1-216-047-00	METAL GLAZE	820 5% 1/10W				
R3038	1-216-049-00	METAL GLAZE	1K 5% 1/10W				
R3039	1-216-055-00	METAL GLAZE	1.8K 5% 1/10W				
R3040	1-216-049-00	METAL GLAZE	1K 5% 1/10W				
R3041	1-216-033-00	METAL GLAZE	220 5% 1/10W				
R3042	1-216-077-00	METAL GLAZE	15K 5% 1/10W				
R3043	1-216-061-00	METAL GLAZE	3.3K 5% 1/10W				
R3044	1-216-049-00	METAL GLAZE	1K 5% 1/10W				
R3045	1-216-077-00	METAL GLAZE	15K 5% 1/10W				
R3046	1-216-061-00	METAL GLAZE	3.3K 5% 1/10W				
R3047	1-216-049-00	METAL GLAZE	1K 5% 1/10W				
R3048	1-216-049-00	METAL GLAZE	1K 5% 1/10W				
R3049	1-216-662-11	METAL CHIP	3K 0.50% 1/10W				
R3050	1-216-069-00	METAL GLAZE	6.8K 5% 1/10W				
R3051	1-216-089-91	METAL GLAZE	47K 5% 1/10W				
R3052	1-216-295-00	METAL GLAZE	0 5% 1/10W				
R3054	1-216-059-00	METAL GLAZE	2.7K 5% 1/10W				
R3055	1-216-053-00	METAL GLAZE	1.5K 5% 1/10W				
R3056	1-216-059-00	METAL GLAZE	2.7K 5% 1/10W				
R3057	1-216-063-00	METAL GLAZE	3.9K 5% 1/10W				
R3058	1-216-049-00	METAL GLAZE	1K 5% 1/10W				
R3059	1-216-689-11	METAL GLAZE	39K 5% 1/10W				
R3060	1-216-063-00	METAL GLAZE	3.9K 5% 1/10W				
R3061	1-216-055-00	METAL GLAZE	1.8K 5% 1/10W				
R3062	1-216-059-00	METAL GLAZE	2.7K 5% 1/10W				
R3063	1-216-061-00	METAL GLAZE	3.3K 5% 1/10W				
R3064	1-216-059-00	METAL GLAZE	2.7K 5% 1/10W				
R3065	1-216-057-00	METAL GLAZE	2.2K 5% 1/10W				
R3066	1-216-057-00	METAL GLAZE	2.2K 5% 1/10W				
R3067	1-216-053-00	METAL GLAZE	1.5K 5% 1/10W				
R3068	1-216-071-00	METAL GLAZE	8.2K 5% 1/10W				
R3069	1-216-063-00	METAL GLAZE	3.9K 5% 1/10W				
R3070	1-216-047-00	METAL GLAZE	820 5% 1/10W				
R3071	1-216-055-00	METAL GLAZE	1.8K 5% 1/10W				
R3072	1-216-059-00	METAL GLAZE	2.7K 5% 1/10W				
R3073	1-216-069-00	METAL GLAZE	6.8K 5% 1/10W				
R3074	1-216-049-00	METAL GLAZE	1K 5% 1/10W				
R3080	1-216-358-91	METAL OXIDE	5.6 5% 1W				
<VARIABLE RESISTOR>							
RV3001	1-238-012-11	RES, ADJ, CARBON 1K					
RV3002	1-238-012-11	RES, ADJ, CARBON 1K					
<TRANSFORMER>							
T3001	1-404-607-11	COIL					
T3002	1-404-607-11	COIL					

*A-1394-446-A X3 BOARD, COMPLETE							

<CAPACITOR>							
C2501	1-124-477-11	ELECT	47MF 20% 16V				
C2502	1-124-477-11	ELECT	47MF 20% 16V				
C2505	1-124-638-11	ELECT	22MF 20% 6.3V				
C2506	1-126-177-11	ELECT	100MF 20% 10V				
C2507	1-126-163-11	ELECT	4.7MF 20% 16V				
<DIODE>							
D2501	8-719-404-46	DIODE MA110					
C2508	1-163-109-00	CERAMIC CHIP	47PF 5% 50V				
C2509	1-126-163-11	ELECT	4.7MF 20% 50V				
C2512	1-163-031-11	CERAMIC CHIP	0.01MF 50V				
C2513	1-163-109-00	CERAMIC CHIP	47PF 5% 50V				
C2514	1-126-163-11	ELECT	4.7MF 20% 16V				
C2516	1-126-163-11	ELECT	4.7MF 20% 50V				
C2517	1-163-031-11	CERAMIC CHIP	0.01MF 50V				
C2518	1-163-031-11	CERAMIC CHIP	0.01MF 50V				
C2519	1-163-031-11	CERAMIC CHIP	0.01MF 50V				
C2520	1-163-031-11	CERAMIC CHIP	0.01MF 50V				
C2521	1-163-088-00	CERAMIC CHIP	5PF 0.25PF 50V				
C2522	1-163-009-11	CERAMIC CHIP	0.001MF 10% 50V				
C2523	1-163-100-00	CERAMIC CHIP	20PF 5% 50V				
C2524	1-163-031-11	CERAMIC CHIP	0.01MF 50V				
C2525	1-163-031-11	CERAMIC CHIP	0.01MF 50V				
C2526	1-163-031-11	CERAMIC CHIP	0.01MF 50V				
C2527	1-163-031-11	CERAMIC CHIP	0.01MF 50V				
C2528	1-163-031-11	CERAMIC CHIP	0.01MF 50V				
C2529	1-163-031-11	CERAMIC CHIP	0.01MF 50V				
C2532	1-126-163-11	ELECT	4.7MF 20% 16V				
C2536	1-124-589-11	ELECT	47MF 20% 16V				
C2537	1-163-031-11	CERAMIC CHIP	0.01MF 50V				
C2540	1-126-163-11	ELECT	4.7MF 20% 16V				
C2544	1-163-031-11	CERAMIC CHIP	0.01MF 50V				
C2545	1-163-031-11	CERAMIC CHIP	0.01MF 50V				
C2546	1-163-031-11	CERAMIC CHIP	0.01MF 50V				
C2547	1-163-031-11	CERAMIC CHIP	0.01MF 50V				
C2548	1-163-031-11	CERAMIC CHIP	0.01MF 50V				
C2549	1-163-031-11	CERAMIC CHIP	0.01MF 50V				
C2550	1-163-031-11	CERAMIC CHIP	0.01MF 50V				
C2551	1-163-031-11	CERAMIC CHIP	0.01MF 50V				
C2552	1-163-031-11	CERAMIC CHIP	0.01MF 50V				
C2553	1-126-177-11	ELECT	100MF 20% 50V				
C2554	1-163-033-00	CERAMIC CHIP	0.022MF 50V				
C2557	1-163-031-11	CERAMIC CHIP	0.01MF 50V				
C2558	1-163-031-11	CERAMIC CHIP	0.01MF 50V				
C2560	1-126-163-11	ELECT	4.7MF 20% 16V				
C2561	1-163-263-11	CERAMIC CHIP	330PF 5% 50V				
C2562	1-163-018-00	CERAMIC CHIP	0.0056MF 10% 50V				
C2563	1-164-695-11	CERAMIC CHIP	0.0022MF 5% 50V				
C2566	1-126-163-11	ELECT	4.7MF 20% 16V				
C2569	1-164-695-11	CERAMIC CHIP	0.0022MF 5% 50V				
C2570	1-163-018-00	CERAMIC CHIP	0.0056MF 10% 50V				
C2571	1-163-263-11	CERAMIC CHIP	330PF 5% 50V				
C2572	1-164-695-11	CERAMIC CHIP	0.0022MF 5% 50V				
C2573	1-163-263-11	CERAMIC CHIP	330PF 5% 50V				
C2574	1-163-018-00	CERAMIC CHIP	0.0056MF 10% 50V				
C2575	1-163-031-11	CERAMIC CHIP	0.01MF 50V				
C2577	1-124-465-00	ELECT	0.47MF 20% 50V				
C2578	1-124-465-00	ELECT	0.47MF 20% 50V				
C2579	1-163-018-00	CERAMIC CHIP	0.0056MF 10% 50V				
C2580	1-163-263-11	CERAMIC CHIP	330PF 5% 50V				
C2581	1-164-695-11	CERAMIC CHIP	0.0022MF 5% 50V				
C2582	1-124-234-00	ELECT	22MF 20% 16V				
C2583	1-124-589-11	ELECT	47MF 20% 16V				
C2590	1-135-179-21	TANTAL. CHIP	2.2MF 20% 16V				
C2591	1-135-179-21	TANTAL. CHIP	2.2MF 20% 16V				
C2592	1-135-179-21	TANTAL. CHIP	2.2MF 20% 16V				
C2593	1-135-179-21	TANTAL. CHIP	2.2MF 20% 16V				

X3

REF. NO.	PART NO.	DESCRIPTION	REMARK	REF. NO.	PART NO.	DESCRIPTION	REMARK
<FERRITE BEAD>				R2511	1-216-667-11	METAL CHIP	4.7K 0.50% 1/10W
FB2502	1-410-397-21	FERRITE BEAD INDUCTOR 1.1UH		R2512	1-216-667-11	METAL CHIP	4.7K 0.50% 1/10W
FB2504	1-410-397-21	FERRITE BEAD INDUCTOR 1.1UH		R2513	1-216-025-00	METAL GLAZE	100 5% 1/10W
<FILTER>				R2518	1-216-025-00	METAL GLAZE	100 5% 1/10W
FL2501	1-236-164-11	ENCAPSULATED COMPONENT		R2519	1-216-025-00	METAL GLAZE	100 5% 1/10W
FL2503	1-236-164-11	ENCAPSULATED COMPONENT		R2520	1-216-025-00	METAL GLAZE	100 5% 1/10W
FL2505	1-236-164-11	ENCAPSULATED COMPONENT		R2521	1-216-025-00	METAL GLAZE	100 5% 1/10W
FL2506	1-236-129-11	ENCAPSULATED COMPONENT		R2522	1-216-025-00	METAL GLAZE	100 5% 1/10W
FL2507	1-236-129-11	ENCAPSULATED COMPONENT		R2531	1-216-049-00	METAL GLAZE	1K 5% 1/10W
FL2508	1-236-129-11	ENCAPSULATED COMPONENT		R2532	1-216-049-00	METAL GLAZE	1K 5% 1/10W
FL2509	1-236-129-11	ENCAPSULATED COMPONENT		R2533	1-216-681-11	METAL CHIP	18K 0.50% 1/10W
<IC>				R2534	1-216-675-11	METAL CHIP	10K 0.50% 1/10W
IC2501	8-759-052-52	IC L78M05T-FA		R2535	1-216-677-11	METAL CHIP	12K 0.50% 1/10W
IC2502	8-759-031-31	IC MC33174M		R2536	1-216-687-11	METAL CHIP	33K 0.50% 1/10W
IC2503	8-752-344-45	IC CXD2555Q		R2537	1-216-685-11	METAL CHIP	27K 0.50% 1/10W
IC2504	8-752-343-18	IC CXD2704Q		R2538	1-216-681-11	METAL CHIP	18K 0.50% 1/10W
IC2506	8-759-031-31	IC MC33174M		R2539	1-216-049-00	METAL GLAZE	1K 5% 1/10W
IC2507	8-752-344-45	IC CXD2555Q		R2540	1-216-049-00	METAL GLAZE	1K 5% 1/10W
IC2508	8-752-844-48	IC CXP5068H-205Q		R2541	1-216-049-00	METAL GLAZE	1K 5% 1/10W
IC2509	8-759-042-02	IC S-80743AL-A7-S		R2542	1-216-049-00	METAL GLAZE	1K 5% 1/10W
IC2510	8-752-332-80	IC CXD1160AQ		R2543	1-216-681-11	METAL CHIP	18K 0.50% 1/10W
IC2511	8-759-932-21	IC MB81256-12PSZ		R2544	1-216-675-11	METAL CHIP	10K 0.50% 1/10W
IC2512	8-759-069-14	IC M51132L		R2545	1-216-687-11	METAL CHIP	33K 0.50% 1/10W
IC2513	8-759-100-96	IC UPC4558G2		R2546	1-216-677-11	METAL CHIP	12K 0.50% 1/10W
<JACK>				R2547	1-216-685-11	METAL CHIP	27K 0.50% 1/10W
J2501	1-573-966-11	PIN, CONNECTOR (PC BOARD) 36P		R2548	1-216-681-11	METAL CHIP	18K 0.50% 1/10W
<COIL>				R2549	1-216-049-00	METAL GLAZE	1K 5% 1/10W
L2501	1-410-204-31	INDUCTOR CHIP 10UH		R2550	1-216-049-00	METAL GLAZE	1K 5% 1/10W
L2504	1-410-204-31	INDUCTOR CHIP 10UH		R2551	1-216-049-00	METAL GLAZE	1K 5% 1/10W
L2505	1-410-196-11	INDUCTOR CHIP 2.2UH		R2552	1-216-025-00	METAL GLAZE	100 5% 1/10W
L2510	1-410-204-31	INDUCTOR CHIP 10UH		R2557	1-216-025-00	METAL GLAZE	100 5% 1/10W
L2511	1-410-204-31	INDUCTOR CHIP 10UH		R2559	1-216-025-00	METAL GLAZE	100 5% 1/10W
L2512	1-410-204-31	INDUCTOR CHIP 10UH		R2560	1-216-025-00	METAL GLAZE	100 5% 1/10W
L2513	1-410-204-31	INDUCTOR CHIP 10UH		R2561	1-216-073-00	METAL GLAZE	10K 5% 1/10W
L2514	1-410-204-31	INDUCTOR CHIP 10UH		R2562	1-216-073-00	METAL GLAZE	10K 5% 1/10W
L2515	1-410-204-31	INDUCTOR CHIP 10UH		R2563	1-216-025-00	METAL GLAZE	100 5% 1/10W
L2516	1-410-204-31	INDUCTOR CHIP 10UH		R2564	1-216-025-00	METAL GLAZE	100 5% 1/10W
L2517	1-410-204-31	INDUCTOR CHIP 10UH		R2565	1-216-089-91	METAL GLAZE	47K 5% 1/10W
<TRANSISTOR>				R2566	1-216-073-00	METAL GLAZE	10K 5% 1/10W
Q2501	8-729-120-28	TRANSISTOR 2SC1623-L5L6		R2567	1-216-073-00	METAL GLAZE	10K 5% 1/10W
<RESISTOR>				R2568	1-216-073-00	METAL GLAZE	10K 5% 1/10W
R2501	1-216-097-00	METAL GLAZE	100K 5% 1/10W	R2569	1-216-073-00	METAL GLAZE	10K 5% 1/10W
R2502	1-216-699-11	METAL CHIP	100K 0.50% 1/10W	R2570	1-216-049-00	METAL GLAZE	1K 5% 1/10W
R2505	1-216-667-11	METAL CHIP	4.7K 0.50% 1/10W	R2571	1-216-025-00	METAL GLAZE	100 5% 1/10W
R2506	1-216-667-11	METAL CHIP	4.7K 0.50% 1/10W	R2572	1-216-025-00	METAL GLAZE	100 5% 1/10W
R2507	1-216-097-00	METAL GLAZE	100K 5% 1/10W	R2573	1-216-025-00	METAL GLAZE	100 5% 1/10W
R2508	1-216-699-11	METAL CHIP	100K 0.50% 1/10W	R2574	1-216-025-00	METAL GLAZE	100 5% 1/10W
R2509	1-216-097-00	METAL GLAZE	100K 5% 1/10W	R2575	1-216-025-00	METAL GLAZE	100 5% 1/10W
R2510	1-216-097-00	METAL GLAZE	100K 5% 1/10W	R2576	1-216-025-00	METAL GLAZE	100 5% 1/10W
				R2577	1-216-025-00	METAL GLAZE	100 5% 1/10W
				R2578	1-216-025-00	METAL GLAZE	100 5% 1/10W
				R2579	1-216-025-00	METAL GLAZE	100 5% 1/10W
				R2583	1-216-025-00	METAL GLAZE	100 5% 1/10W
				R2584	1-216-025-00	METAL GLAZE	100 5% 1/10W
				R2585	1-216-025-00	METAL GLAZE	100 5% 1/10W
				R2590	1-216-631-11	METAL CHIP	150 0.50% 1/10W
				R2591	1-216-631-11	METAL CHIP	150 0.50% 1/10W
				R2592	1-216-665-11	METAL CHIP	3.9K 0.50% 1/10W
				R2593	1-216-665-11	METAL CHIP	3.9K 0.50% 1/10W
				R2594	1-216-665-11	METAL CHIP	3.9K 0.50% 1/10W
				R2595	1-216-665-11	METAL CHIP	3.9K 0.50% 1/10W
				R2596	1-216-665-11	METAL CHIP	3.9K 0.50% 1/10W
				R2597	1-216-665-11	METAL CHIP	3.9K 0.50% 1/10W

X3 Y2

REF. NO.	PART NO.	DESCRIPTION	REMARK	REF. NO.	PART NO.	DESCRIPTION	REMARK
R2598	1-216-665-11	METAL CHIP	3.9K 0.50% 1/10W	C462	1-124-499-11	ELECT 1MF	20% 50V
R2599	1-216-665-11	METAL CHIP	3.9K 0.50% 1/10W	C465	1-130-485-00	MYLAR 0.015MF	5% 50V
R2600	1-216-665-11	METAL CHIP	3.9K 0.50% 1/10W	C466	1-130-485-00	MYLAR 0.015MF	5% 50V
R2601	1-216-665-11	METAL CHIP	3.9K 0.50% 1/10W	C467	1-136-169-00	FILM 0.22MF	5% 50V
R2602	1-216-665-11	METAL CHIP	3.9K 0.50% 1/10W	C468	1-136-169-00	FILM 0.22MF	5% 50V
R2603	1-216-665-11	METAL CHIP	3.9K 0.50% 1/10W	C469	1-126-157-11	ELECT 10MF	20% 16V
R2605	1-216-679-11	METAL CHIP	15K 0.50% 1/10W	C470	1-126-157-11	ELECT 10MF	20% 16V
R2606	1-216-679-11	METAL CHIP	15K 0.50% 1/10W	C471	1-124-589-11	ELECT 47MF	20% 16V
R2607	1-216-679-11	METAL CHIP	15K 0.50% 1/10W	C472	1-164-232-11	CERAMIC CHIP 0.01MF	10% 50V
R2608	1-216-679-11	METAL CHIP	15K 0.50% 1/10W	C473	1-164-232-11	CERAMIC CHIP 0.01MF	10% 50V
R2609	1-216-025-00	METAL GLAZE	100 5% 1/10W	C474	1-124-234-00	ELECT 22MF	20% 16V
R2610	1-216-025-00	METAL GLAZE	100 5% 1/10W	C475	1-164-232-11	CERAMIC CHIP 0.01MF	10% 50V
R2611	1-216-025-00	METAL GLAZE	100 5% 1/10W	C476	1-124-234-00	ELECT 22MF	20% 16V
R2612	1-216-025-00	METAL GLAZE	100 5% 1/10W	C477	1-164-232-11	CERAMIC CHIP 0.01MF	10% 50V
<CRYSTAL>				C478	1-124-478-11	ELECT 100MF	20% 25V
X2501	1-579-692-31	VIBRATOR, CRYSTAL		C479	1-126-163-11	ELECT 4.7MF	20% 50V
*****				C480	1-124-768-11	ELECT 4.7MF	20% 50V
*A-1394-442-A	Y2 BOARD, COMPLETE			C481	1-124-768-11	ELECT 4.7MF	20% 50V
*****				C482	1-126-163-11	ELECT 4.7MF	20% 50V
<CAPACITOR>				C483	1-163-113-00	CERAMIC CHIP 68PF	5% 50V
C401	1-124-234-00	ELECT	22MF 20% 16V	C484	1-163-113-00	CERAMIC CHIP 68PF	5% 50V
C424	1-126-301-11	ELECT	1MF 20% 50V	C485	1-163-038-00	CERAMIC CHIP 0.1MF	25V
C425	1-126-301-11	ELECT	1MF 20% 50V	C487	1-164-232-11	CERAMIC CHIP 0.01MF	10% 50V
C426	1-126-301-11	ELECT	1MF 20% 50V	C488	1-164-232-11	CERAMIC CHIP 0.01MF	10% 50V
C427	1-124-465-00	ELECT	0.47MF 20% 50V	<DIODE>			
C428	1-126-163-11	ELECT	4.7MF 20% 50V	D405	8-719-107-13	DIODE RD18M-B1	
C429	1-124-478-11	ELECT	100MF 20% 25V	D406	8-719-107-13	DIODE RD18M-B1	
C430	1-124-261-00	ELECT	10MF 20% 50V	D407	8-719-107-13	DIODE RD18M-B1	
C431	1-126-301-11	ELECT	1MF 20% 50V	D408	8-719-105-83	DIODE RD5.1M-B3	
C432	1-126-301-11	ELECT	1MF 20% 50V	D409	8-719-981-50	DIODE RB-100A	
C433	1-131-347-00	TANTALUM	1MF 20% 16V	D410	8-719-981-50	DIODE RB-100A	
C434	1-126-301-11	ELECT	1MF 20% 50V	D413	8-719-158-19	DIODE RD6.2SB	
C435	1-130-994-11	FILM	0.033MF 5% 50V	D414	8-719-158-55	DIODE RD15SB	
C436	1-126-301-11	ELECT	1MF 20% 50V	D415	8-719-158-55	DIODE RD15SB	
C437	1-137-372-11	FILM	0.022MF 5% 50V	<IC>			
C438	1-126-301-11	ELECT	1MF 20% 50V	IC403	8-759-996-43	IC RC4558PS	
C439	1-124-034-51	ELECT	33MF 20% 16V	IC404	8-759-067-24	IC 24C04A1/P	
C440	1-126-301-11	ELECT	1MF 20% 50V	IC406	8-752-037-24	IC CXA1264AS	
C441	1-126-301-11	ELECT	1MF 20% 50V	IC407	8-759-245-75	IC TA8184P	
C442	1-124-261-00	ELECT	10MF 20% 50V	IC408	8-752-057-18	IC CXA1315P	
C443	1-124-589-11	ELECT	47MF 20% 16V	<TRANSISTOR>			
C444	1-126-163-11	ELECT	4.7MF 20% 50V	Q404	8-729-216-22	TRANSISTOR 2SA1162-G	
C445	1-126-163-11	ELECT	4.7MF 20% 50V	Q405	8-729-216-22	TRANSISTOR 2SA1162-G	
C446	1-124-234-00	ELECT	22MF 20% 16V	Q409	8-729-120-28	TRANSISTOR 2SC1623-L5L6	
C447	1-126-301-11	ELECT	1MF 20% 50V	Q410	8-729-120-28	TRANSISTOR 2SC1623-L5L6	
C448	1-136-170-00	FILM	0.27MF 5% 50V	<RESISTOR>			
C449	1-163-009-11	CERAMIC CHIP	0.001MF 10% 50V	R447	1-216-033-00	METAL GLAZE 220 5% 1/10W	
C450	1-137-366-11	FILM	0.0022MF 5% 50V	R453	1-216-033-00	METAL GLAZE 220 5% 1/10W	
C451	1-124-261-00	ELECT	10MF 20% 50V	R464	1-216-081-00	METAL GLAZE 22K 5% 1/10W	
C452	1-124-261-00	ELECT	10MF 20% 50V	R465	1-216-081-00	METAL GLAZE 22K 5% 1/10W	
C453	1-137-366-11	FILM	0.0022MF 5% 50V	R466	1-216-025-00	METAL GLAZE 100 5% 1/10W	
C454	1-131-368-00	TANTALUM	3.3MF 10% 16V	R467	1-216-033-00	METAL GLAZE 220 5% 1/10W	
C455	1-131-347-00	TANTALUM	1MF 20% 16V	R468	1-216-033-00	METAL GLAZE 220 5% 1/10W	
C456	1-136-171-00	FILM	0.33MF 5% 50V	R469	1-216-055-00	METAL GLAZE 1.8K 5% 1/10W	
C457	1-136-175-00	FILM	0.68MF 5% 50V	R470	1-216-033-00	METAL GLAZE 220 5% 1/10W	
C458	1-126-101-11	ELECT	100MF 20% 16V	R471	1-216-033-00	METAL GLAZE 220 5% 1/10W	
C459	1-126-101-11	ELECT	100MF 20% 16V				
C460	1-126-101-11	ELECT	100MF 20% 16V				
C461	1-124-499-11	ELECT	1MF 20% 50V				

The components identified by shading and mark Δ are critical for safety. Replace only with part number specified.

Les composants identifiés par une trame et par une marque Δ sont d'une importance critique pour la sécurité. Ne les remplacer que par des pièces de numéro spécifié.

Y2

G

REF. NO.	PART NO.	DESCRIPTION	REMARK	REF. NO.	PART NO.	DESCRIPTION	REMARK
R472	1-216-686-11	METAL CHIP 30K 0.50% 1/10W					
R473	1-216-295-00	METAL GLAZE 0 5% 1/10W					
R474	1-216-295-00	METAL GLAZE 0 5% 1/10W					
R475	1-216-055-00	METAL GLAZE 1.8K 5% 1/10W					
R476	1-216-673-11	METAL CHIP 8.2K 0.50% 1/10W					
R477	1-216-676-11	METAL CHIP 11K 0.50% 1/10W					
R478	1-216-089-91	METAL GLAZE 47K 5% 1/10W					
R479	1-216-673-11	METAL CHIP 8.2K 0.50% 1/10W					
R480	1-216-676-11	METAL CHIP 11K 0.50% 1/10W					
R481	1-216-089-91	METAL GLAZE 47K 5% 1/10W					
R482	1-216-089-91	METAL GLAZE 47K 5% 1/10W					
R483	1-216-089-91	METAL GLAZE 47K 5% 1/10W					
R485	1-216-073-00	METAL GLAZE 10K 5% 1/10W					
R486	1-216-073-00	METAL GLAZE 10K 5% 1/10W					
R488	1-216-295-00	METAL GLAZE 0 5% 1/10W					
R494	1-216-025-00	METAL GLAZE 100 5% 1/10W					
R495	1-216-025-00	METAL GLAZE 100 5% 1/10W					
R496	1-216-025-00	METAL GLAZE 100 5% 1/10W					
R497	1-216-033-00	METAL GLAZE 220 5% 1/10W					
R498	1-216-025-00	METAL GLAZE 100 5% 1/10W					
R499	1-216-025-00	METAL GLAZE 100 5% 1/10W					
R500	1-216-081-00	METAL GLAZE 22K 5% 1/10W					
R501	1-216-669-11	METAL CHIP 5.6K 0.50% 1/10W					
R502	1-216-033-00	METAL GLAZE 220 5% 1/10W					
R503	1-216-663-11	METAL CHIP 3.3K 0.50% 1/10W					
R504	1-216-669-11	METAL CHIP 5.6K 0.50% 1/10W					
R507	1-216-295-00	METAL GLAZE 0 5% 1/10W					
R509	1-216-065-00	METAL GLAZE 4.7K 5% 1/10W					
R510	1-216-061-00	METAL GLAZE 3.3K 5% 1/10W					
R512	1-216-065-00	METAL GLAZE 4.7K 5% 1/10W					
R513	1-216-663-11	METAL CHIP 3.3K 0.50% 1/10W					
R515	1-216-295-00	METAL GLAZE 0 5% 1/10W					
R517	1-216-025-00	METAL GLAZE 100 5% 1/10W					
R518	1-216-089-91	METAL GLAZE 47K 5% 1/10W					
R519	1-216-295-00	METAL GLAZE 0 5% 1/10W					
R521	1-216-061-00	METAL GLAZE 3.3K 5% 1/10W					
R522	1-216-033-00	METAL GLAZE 220 5% 1/10W					
R523	1-216-033-00	METAL GLAZE 220 5% 1/10W					
R524	1-216-065-00	METAL GLAZE 4.7K 5% 1/10W					
R525	1-216-049-00	METAL GLAZE 1K 5% 1/10W					
R526	1-216-049-00	METAL GLAZE 1K 5% 1/10W					
R527	1-218-753-11	METAL CHIP 110K 0.50% 1/10W					
R528	1-216-689-11	METAL CHIP 39K 0.50% 1/10W					
R529	1-216-097-00	METAL GLAZE 100K 5% 1/10W					
R531	1-216-097-00	METAL GLAZE 100K 5% 1/10W					
R532	1-216-097-00	METAL GLAZE 100K 5% 1/10W					
R533	1-216-097-00	METAL GLAZE 100K 5% 1/10W					
R535	1-216-049-00	METAL GLAZE 1K 5% 1/10W					
R536	1-216-065-00	METAL GLAZE 4.7K 5% 1/10W					
R537	1-216-049-00	METAL GLAZE 1K 5% 1/10W					
R538	1-218-753-11	METAL CHIP 110K 0.50% 1/10W					
R539	1-216-689-11	METAL CHIP 39K 0.50% 1/10W					
R540	1-216-025-00	METAL GLAZE 100 5% 1/10W					
R541	1-216-025-00	METAL GLAZE 100 5% 1/10W					
R542	1-216-025-00	METAL GLAZE 100 5% 1/10W					
R543	1-216-025-00	METAL GLAZE 100 5% 1/10W					
R546	1-216-682-11	METAL CHIP 20K 0.50% 1/10W					
R547	1-216-682-11	METAL CHIP 20K 0.50% 1/10W					
<CONNECTOR>							
Y2-401	1-573-966-11	PIN, CONNECTOR (PC BOARD) 36P					

				*A-1316-178-A	G BOARD, COMPLETE *****		
				3-701-754-00	PLATE, INSULATING		
				4-382-854-11	SCREW (M3X10), P, SW (+)		
				<CAPACITOR>			
				C601	1-161-830-00	CERAMIC 4700PF	10% 500V
				C602	1-130-317-00	FILM 0.068MF	5% 100V
				C603	1-124-634-11	ELECT 1MF	20% 250V
				C605	1-164-143-11	CERAMIC 0.001MF	10% 1KV
				C606	1-124-563-11	ELECT 2200MF	20% 25V
				C607	1-124-563-11	ELECT 2200MF	20% 25V
				C608	1-128-484-11	ELECT 100MF	20% 200V
				C609	1-137-141-11	FILM 0.082MF	3% 600V
				C612	1-124-962-11	ELECT 2200MF	20% 25V
				C614	1-104-966-11	ELECT 10MF	0 200V
				C615	1-124-798-11	ELECT 1MF	20% 160V
				C616	1-124-557-11	ELECT 1000MF	20% 25V
				C617	1-164-143-11	CERAMIC 0.001MF	10% 1KV
				C618	1-136-853-11	FILM 0.56MF	5% 200V
				C619	1-164-735-11	CAP, CERAMIC 1500PF	
				C620	1-136-721-21	FILM 1.5MF	10% 400V
				C621	1-164-143-11	CERAMIC 0.001MF	10% 1KV
				C622	1-136-853-11	FILM 0.56MF	5% 200V
				C623	1-137-087-11	FILM 0.068MF	3% 0
				C624	1-126-771-11	ELECT 100MF	20% 160V
				C625	1-126-183-11	ELECT 1000MF	20% 16V
				C626	1-126-373-11	ELECT 470MF	20% 10V
				C628	1-161-830-00	CERAMIC 4700PF	10% 500V
				C631	1-126-803-11	ELECT 47MF	20% 50V
				C632	1-124-903-11	ELECT 1MF	20% 50V
				C633	1-130-483-00	MYLAR 0.01MF	5% 50V
				C634	1-126-803-11	ELECT 47MF	20% 16V
				C637	Δ 1-136-311-51	FILM 0.47MF	20% 125V
				C638	Δ 1-161-743-12	CERAMIC 0.0047MF	400V
				C639	Δ 1-125-692-11	ELECT (BLOCK) 820MF	20% 200V
				C640	Δ 1-136-311-51	FILM 0.47MF	20% 125V
				C641	1-126-101-11	ELECT 100MF	20% 16V
				C642	Δ 1-161-743-12	CERAMIC 0.0047MF	400V
				C644	1-126-104-11	ELECT 470MF	20% 35V
				C646	1-124-907-11	ELECT 10MF	20% 50V
				C647	Δ 1-164-486-51	CERAMIC 0.0033MF	20% 400V
				C648	Δ 1-125-692-11	ELECT (BLOCK) 820MF	20% 200V
				C649	Δ 1-164-486-51	CERAMIC 0.0033MF	20% 400V
				C650	Δ 1-161-743-12	CERAMIC 0.0047MF	400V
				C660	1-102-125-00	CERAMIC 0.0047MF	10% 50V
				C661	1-102-125-00	CERAMIC 0.0047MF	10% 50V
				C662	1-124-910-11	ELECT 47MF	20% 35V
				C663	1-126-946-11	ELECT 6800MF	20% 16V
				C664	1-126-946-11	ELECT 6800MF	20% 16V
				C670	1-102-074-00	CERAMIC 0.001MF	10% 50V
				C671	1-126-101-11	ELECT 100MF	20% 16V
				<DIODE>			
				D602	8-719-979-58	DIODE EGP10D	
				D603	8-719-500-67	DIODE D5KC40H	
				D604	8-719-510-09	DIODE D10SC6M	
				D605	8-719-988-31	DIODE D10SC6MR	
				D607	8-719-025-81	DIODE S3V10SB	
				D608	8-719-109-85	DIODE RD5.1ESB2	

G

Les composants identifiés par une trame et par une marque Δ sont d'une importance critique pour la sécurité. Ne les remplacer que par des pièces de numéro spécifié.

The components identified by shading and mark Δ are critical for safety. Replace only with part number specified.

REF. NO.	PART NO.	DESCRIPTION	REMARK	REF. NO.	PART NO.	DESCRIPTION	REMARK
D609	8-719-109-84	DIODE RD5.1ESB1					
D610	8-719-979-58	DIODE EGP10D					
D611	8-719-979-58	DIODE EGP10D					
D613	8-719-300-33	DIODE RU-3AM					
D614	8-719-979-58	DIODE EGP10D					
D615	8-719-975-76	DIODE SB140					
D616	8-719-025-81	DIODE S3V10SB					
D617	8-719-110-02	DIODE RD7.5ESB1					
D618	8-719-911-19	DIODE 1SS119					
D619	8-719-975-76	DIODE SB140					
D621	8-719-908-03	DIODE GP08D					
D622	8-719-908-03	DIODE GP08D					
D623	8-719-110-63	DIODE RD24ESB3					
D624	8-719-109-89	DIODE RD5.6ESB2					
D626	8-719-908-03	DIODE GP08D					
D628	8-719-110-49	DIODE RD18ESB2					
D629	8-719-911-19	DIODE 1SS119					
D631	8-719-911-19	DIODE 1SS119					
D632	8-719-511-40	DIODE S1VB40					
D633	Δ 8-719-505-60	DIODE S5VB60					
D634	8-719-911-19	DIODE 1SS119					
D636	8-719-109-85	DIODE RD5.1ESB2					
D638	8-719-911-19	DIODE 1SS119					
D650	8-719-160-81	DIODE RD27FB2					
<FUSE>							
F601	Δ 1-532-748-11	FUSE, GLASS TUBE 6.3A/125V					
	1-533-223-11	CLIP, FUSE; F601					
<FERRITE BEAD>							
FB602	1-410-397-21	FERRITE BEAD INDUCTOR 1.1UH					
FB604	1-410-396-41	FERRITE BEAD INDUCTOR 0.45UH					
FB606	1-410-397-21	FERRITE BEAD INDUCTOR 1.1UH					
FB607	1-410-397-21	FERRITE BEAD INDUCTOR 1.1UH					
FB608	1-410-396-41	FERRITE BEAD INDUCTOR 0.45UH					
FB630	1-410-396-41	FERRITE BEAD INDUCTOR 0.45UH					
FB631	1-410-396-41	FERRITE BEAD INDUCTOR 0.45UH					
<CONNECTOR>							
G-1	1-508-786-00	PIN, CONNECTOR (5MM PITCH) 2P					
G-2	*1-564-512-11	PLUG, CONNECTOR 9P					
G-4	*1-564-511-51	PLUG, CONNECTOR 8P					
G-5	*1-564-508-11	PLUG, CONNECTOR 5P					
G-7	*1-564-507-11	PLUG, CONNECTOR 4P					
G-8	*1-580-843-11	PIN, CONNECTOR (POWER)					
G-9	1-508-765-00	PIN, CONNECTOR (5MM PITCH) 3P					
G-10	1-508-786-00	PIN, CONNECTOR (5MM PITCH) 2P					
G-11	*1-564-511-71	PLUG, CONNECTOR 8P					
G-12	1-564-505-11	PLUG, CONNECTOR 2P					
<IC>							
IC601	Δ 8-749-921-89	IC SE115N					
IC602	8-759-231-58	IC TA7812S					
<JUMPER COIL>							
JW76	1-408-421-00	INDUCTOR 100UH					
				<COIL>			
L602	1-459-862-11	COIL, CHOKE 90UH					
L604	1-408-404-00	INDUCTOR 3.9UH					
L605	1-412-526-11	INDUCTOR 12UH					
L607	1-408-404-00	INDUCTOR 3.9UH					
L611	1-412-546-41	INDUCTOR 560UH					
L612	1-412-540-31	INDUCTOR 180UH					
				<TRANSISTOR>			
Q603	8-729-011-15	TRANSISTOR 2SC4582NP					
Q604	8-729-119-80	TRANSISTOR 2SC2688-LK					
Q607	8-729-119-78	TRANSISTOR 2SC2785-HFE					
Q608	8-729-326-11	TRANSISTOR 2SC2611					
Q609	8-729-119-76	TRANSISTOR 2SA1175-HFE					
Q610	8-729-820-82	TRANSISTOR 2SA1208-S					
Q611	8-729-820-82	TRANSISTOR 2SA1208-S					
Q612	8-729-386-12	TRANSISTOR 2SB861-C					
Q613	8-729-209-15	TRANSISTOR 2SD2012					
Q614	8-729-011-15	TRANSISTOR 2SC4582NP					
Q615	8-729-820-82	TRANSISTOR 2SA1208-S					
Q616	8-729-017-05	TRANSISTOR 2SA1837					
Q618	8-729-119-76	TRANSISTOR 2SA1175-HFE					
Q620	8-729-119-78	TRANSISTOR 2SC2785-HFE					
Q621	8-729-119-78	TRANSISTOR 2SC2785-HFE					
Q623	8-729-119-76	TRANSISTOR 2SA1175-HFE					
Q629	8-729-378-84	TRANSISTOR 2SD788-5					
Q630	8-729-255-12	TRANSISTOR 2SC2551-0					
				<RESISTOR>			
R604	1-202-933-61	FUSIBLE 0.1 10%	1/2W F				
R605	1-249-428-11	CARBON 8.2K 5%	1/4W				
R606	1-214-919-00	METAL 180K 1%	1/2W				
R609	1-249-434-11	CARBON 27K 5%	1/4W F				
R610	1-215-469-00	METAL 100K 1%	1/4W				
R611	1-249-421-11	CARBON 2.2K 5%	1/4W F				
R612	1-202-883-11	SOLID 680K 20%	1/2W				
R613	Δ 1-216-386-91	METAL OXIDE 0.56 5%	3W F				
R614	1-249-418-11	CARBON 1.2K 5%	1/4W				
R615	1-215-438-00	METAL 5.1K 1%	1/4W				
R616	1-215-436-00	METAL 4.3K 1%	1/4W				
R617	Δ 1-216-356-91	METAL OXIDE 3.9 5%	1W F				
R618	1-249-418-11	CARBON 1.2K 5%	1/4W				
R619	Δ 1-216-444-91	METAL OXIDE 82K 5%	1W F				
R620	1-249-418-11	CARBON 1.2K 5%	1/4W F				
R621	1-247-691-11	CARBON 18 5%	1/4W F				
R622	1-249-424-11	CARBON 3.9K 5%	1/4W F				
R623	1-249-417-11	CARBON 1K 5%	1/4W				
R624	1-214-780-00	METAL 130K 1%	1/4W				
R625	Δ 1-216-386-91	METAL OXIDE 0.56 5%	3W F				
R626	Δ 1-216-356-91	METAL OXIDE 3.9 5%	1W F				
R627	1-202-883-11	SOLID 680K 20%	1/2W				
R628	1-249-410-11	CARBON 270 5%	1/4W F				
R629	Δ 1-217-249-11	WIREWOUND 1 10%	3W F				
R631	1-249-417-11	CARBON 1K 5%	1/4W F				
R632	1-214-913-00	METAL 100K 1%	1/2W				
R633	1-249-429-11	CARBON 10K 5%	1/4W				
R634	1-249-441-11	CARBON 100K 5%	1/4W				
R638	1-247-807-31	CARBON 100 5%	1/4W F				
R639	1-247-807-31	CARBON 100 5%	1/4W F				
R640	1-249-421-11	CARBON 2.2K 5%	1/4W F				
R641	1-249-429-11	CARBON 10K 5%	1/4W				
R642	1-215-421-00	METAL 1K 1%	1/4W				
R643	1-260-123-11	CARBON 100K 5%	1/2W				

The components identified by shading and mark **Δ** are critical for safety.
Replace only with part number specified.

Les composants identifiés par une trame et par une marque **Δ** sont d'une importance critique pour la sécurité. Ne les remplacer que par des pièces de numéro spécifié.

G **CR**

REF. NO.	PART NO.	DESCRIPTION	REMARK
R644	1-249-415-11	CARBON	680 5% 1/4W
R645	1-249-417-11	CARBON	1K 5% 1/4W
R649	1-249-424-11	CARBON	3.9K 5% 1/4W
R650	1-249-377-11	CARBON	0.47 5% 1/4W F
R651	1-215-429-00	METAL	2.2K 1% 1/4W
Δ R652	Δ	METAL	1/4W
R654	1-215-429-00	METAL	2.2K 1% 1/4W
R655	1-249-426-11	CARBON	5.6K 5% 1/4W
R656	1-215-454-00	METAL	24K 1% 1/4W
R657	Δ 1-216-386-91	METAL OXIDE	0.56 5% 3W F
R660	1-249-413-11	CARBON	470 5% 1/4W
R661	Δ 1-202-884-91	SOLID	820K 20% 1/2W
R662	Δ 1-205-900-11	WIREWOUND	1.2 5% 15W
R663	Δ 1-215-904-91	METAL OXIDE	100K 5% 2W F
R666	1-249-377-11	CARBON	0.47 5% 1/4W F
R667	Δ 1-202-888-91	SOLID	2.2M 20% 1/2W
R668	Δ 1-215-904-91	METAL OXIDE	100K 5% 2W F
R669	1-249-377-11	CARBON	0.47 5% 1/4W F
R675	1-249-377-11	CARBON	0.47 5% 1/4W F
R687	1-249-417-11	CARBON	1K 5% 1/4W F
R689	1-247-742-11	CARBON	180 5% 1/2W F
R691	1-249-421-11	CARBON	2.2K 5% 1/4W
R694	1-249-421-11	CARBON	2.2K 5% 1/4W
R697	1-249-382-11	CARBON	1.2 5% 1/4W F
R698	Δ 1-216-386-91	METAL OXIDE	0.56 5% 3W F
<RELAY>			
RY601	Δ 1-515-805-21	RELAY, POWER	
RY602	Δ 1-515-805-21	RELAY, POWER	
<TRANSFORMER>			
T601	Δ 1-450-791-12	TRANSFORMER, POWER ISOLATION	
T603	Δ 1-424-020-11	PRT	
T604	Δ 1-450-149-11	TRANSFORMER, HEATER	
T605	Δ 1-424-023-12	TRANSFORMER, LINE FILTER	
T606	Δ 1-421-372-21	TRANSFORMER, FERRITE (LFT)	
T608	Δ 1-423-665-11	TRANSFORMER, POWER	
<VARISTOR>			
VDR601	Δ 1-809-786-11	VARISTOR	

*A-1331-259-A CR BOARD, COMPLETE			

<CAPACITOR>			
C701	1-162-115-00	CERAMIC	330PF 10% 2KV
C702	1-123-948-00	ELECT	22MF 20% 250V
C703	1-102-050-00	CERAMIC	0.01MF 500V
C704	1-162-115-00	CERAMIC	330PF 10% 2KV
C705	1-130-479-00	MYLAR	0.0047MF 5% 50V
C706	1-101-006-00	CERAMIC	0.047MF 50V
C707	1-101-006-00	CERAMIC	0.047MF 50V
C709	1-124-120-11	ELECT	220MF 20% 16V
C710	1-124-120-11	ELECT	220MF 20% 16V
C711	1-102-114-00	CERAMIC	470PF 10% 50V
<CONNECTOR>			
CR1	1-508-784-00	PIN, CONNECTOR (5MM PITCH) 1P	

REF. NO.	PART NO.	DESCRIPTION	REMARK
CR3	*1-508-765-00	PIN, CONNECTOR (5MM PITCH) 3P	
CR4	1-564-511-11	PLUG, CONNECTOR 8P	
CR15	*1-564-508-11	PLUG, CONNECTOR 5P	
<SOCKET>			
CRT701	Δ 1-251-026-11	SOCKET, PICTURE TUBE	
<DIODE>			
D701	8-719-911-19	DIODE 1SS119	
D702	8-719-911-19	DIODE 1SS119	
D703	8-719-911-19	DIODE 1SS119	
D704	8-719-911-19	DIODE 1SS119	
D705	8-719-911-19	DIODE 1SS119	
D706	8-719-911-19	DIODE 1SS119	
D707	8-719-110-36	DIODE RD13ESB2	
<COIL>			
L701	1-408-429-00	INDUCTOR	470UH
L702	1-249-470-11	CARBON	0.47 5% 1/2W F
L704	1-408-413-00	INDUCTOR	22UH
<NEON LAMP>			
NL701	1-519-108-99	LAMP, NEON	
NL702	1-519-108-99	LAMP, NEON	
<TRANSISTOR>			
Q701	8-729-119-78	TRANSISTOR 2SC2785-HFE	
Q702	8-729-119-78	TRANSISTOR 2SC2785-HFE	
Q703	8-729-119-80	TRANSISTOR 2SC2688-LK	
	4-373-933-01	SHEET (TRANSISTOR), BN;	Q703
	4-382-854-11	SCREW (M3X10), P, SW (+);	Q703
Q704	8-729-255-12	TRANSISTOR 2SC2551-0	
Q705	8-729-200-17	TRANSISTOR 2SA1091-0	
Q706	8-729-200-17	TRANSISTOR 2SA1091-0	
<RESISTOR>			
R701	1-202-847-00	SOLID	560K 20% 1/2W
R702	1-202-814-11	SOLID	33K 20% 1/2W
R703	1-202-818-00	SOLID	1K 20% 1/2W
R704	1-202-842-11	SOLID	220K 20% 1/2W
R705	1-202-828-11	SOLID	6.8K 20% 1/2W
R706	1-202-561-00	SOLID	330 20% 1/2W
R707	Δ 1-216-510-51	METAL OXIDE	8.2K 5% 5W F
R708	1-247-807-31	CARBON	100 5% 1/4W F
R709	1-247-807-31	CARBON	100 5% 1/4W F
R710	Δ 1-215-927-91	METAL OXIDE	47K 5% 3W F
R711	1-247-807-31	CARBON	100 5% 1/4W F
R712	1-249-421-11	CARBON	2.2K 5% 1/4W F
R714	1-249-401-11	CARBON	47 5% 1/4W
R716	1-247-807-31	CARBON	100 5% 1/4W
R717	1-249-403-11	CARBON	68 5% 1/4W
R718	1-249-412-11	CARBON	390 5% 1/4W
R719	1-249-410-11	CARBON	270 5% 1/4W
R720	1-247-807-31	CARBON	100 5% 1/4W
R721	1-249-409-11	CARBON	220 5% 1/4W
R722	1-215-423-00	METAL	1.2K 1% 1/4W
R723	1-249-410-11	CARBON	270 5% 1/4W
R724	1-215-429-00	METAL	2.2K 1% 1/4W

• The components identified by **Δ** in this manual have been carefully factory-selected for each set in order to satisfy regulations regarding X-ray radiation. Should replacement be required, replace only with the value originally used.

• * : Selected to yield optimum performance.

The components identified by shading and mark Δ are critical for safety. Replace only with part number specified.

Les composants identifiés par une trame et par une marque Δ sont d'une importance critique pour la sécurité. Ne les remplacer que par des pièces de numéro spécifié.

CB D

REF. NO.	PART NO.	DESCRIPTION	REMARK	REF. NO.	PART NO.	DESCRIPTION	REMARK
<DIODE>				*A-1341-726-A D BOARD, COMPLETE *****			
D761	8-719-911-19	DIODE 1SS119		4-382-854-11	SCREW (M3X10), P, SW (+)		
D762	8-719-911-19	DIODE 1SS119		<CAPACITOR>			
D763	8-719-911-19	DIODE 1SS119		C901	1-126-320-11	ELECT 10MF	20% 16V
D764	8-719-911-19	DIODE 1SS119		C902	1-124-477-11	ELECT 47MF	20% 16V
D765	8-719-911-19	DIODE 1SS119		C903	1-130-471-00	MYLAR 0.001MF	5% 50V
D766	8-719-911-19	DIODE 1SS119		C904	1-130-471-00	MYLAR 0.001MF	5% 50V
D768	8-719-911-19	DIODE 1SS119		C905	1-124-477-11	ELECT 47MF	20% 16V
D769	8-719-109-81	DIODE RD4.7ESB2		C906	1-126-233-11	ELECT 22MF	20% 50V
<COIL>				C907	1-126-101-11	ELECT 100MF	20% 16V
L761	1-408-429-00	INDUCTOR 470UH		C908	1-124-907-11	ELECT 10MF	20% 50V
L762	1-249-470-11	CARBON 0.47 5%	1/2W F	C910	1-130-483-00	MYLAR 0.01MF	5% 50V
L764	1-408-413-00	INDUCTOR 22UH		C911	1-131-341-00	TANTALUM 0.1MF	20% 16V
<NEON LAMP>				C912	1-124-903-11	ELECT 1MF	20% 50V
NL761	1-519-108-99	LAMP, NEON		C913	1-126-233-11	ELECT 22MF	20% 50V
NL762	1-519-108-99	LAMP, NEON		C914	1-126-803-11	ELECT 47MF	20% 16V
<TRANSISTOR>				C915	1-124-927-11	ELECT 4.7MF	20% 50V
Q761	8-729-119-78	TRANSISTOR 2SC2785-HFE		C916	1-102-074-00	CERAMIC 0.001MF	10% 50V
Q762	8-729-119-78	TRANSISTOR 2SC2785-HFE		C917	1-130-471-00	MYLAR 0.001MF	5% 50V
Q763	8-729-119-80	TRANSISTOR 2SC2688-LK		C918	1-102-963-00	CERAMIC 33PF	5% 50V
Q764	8-729-255-12	TRANSISTOR 2SC2551-0		C919	1-102-963-00	CERAMIC 33PF	5% 50V
Q765	8-729-200-17	TRANSISTOR 2SA1091-0		C920	1-102-963-00	CERAMIC 33PF	5% 50V
Q766	8-729-200-17	TRANSISTOR 2SA1091-0		C921	1-102-963-00	CERAMIC 33PF	5% 50V
<RESISTOR>				C922	1-102-963-00	CERAMIC 33PF	5% 50V
R761	1-202-847-00	SOLID 560K 20%	1/2W	C923	1-102-963-00	CERAMIC 33PF	5% 50V
R762	1-202-814-11	SOLID 33K 20%	1/2W	C931	1-102-973-00	CERAMIC 100PF	5% 50V
R763	1-202-818-00	SOLID 1K 20%	1/2W	C932	1-124-903-11	ELECT 1MF	20% 50V
R764	1-202-842-11	SOLID 220K 20%	1/2W	C933	1-126-233-11	ELECT 22MF	20% 25V
R765	1-202-828-11	SOLID 6.8K 20%	1/2W	C934	1-126-233-11	ELECT 22MF	20% 25V
R766	1-202-561-00	SOLID 330 20%	1/2W	C935	1-126-233-11	ELECT 22MF	20% 25V
R767 Δ	1-216-510-51	METAL OXIDE 8.2K 5%	5W F	C936	1-126-233-11	ELECT 22MF	20% 25V
R768	1-247-807-31	CARBON 100 5%	1/4W F	C937	1-126-233-11	ELECT 22MF	20% 25V
R769	1-247-807-31	CARBON 100 5%	1/4W F	C938	1-126-233-11	ELECT 22MF	20% 25V
R770 Δ	1-215-927-91	METAL OXIDE 47K 5%	3W F	C939	1-126-233-11	ELECT 22MF	20% 25V
R771	1-247-807-31	CARBON 100 5%	1/4W F	C940	1-126-233-11	ELECT 22MF	20% 25V
R772	1-249-421-11	CARBON 2.2K 5%	1/4W F	C941	1-102-123-00	CERAMIC 0.0033MF	10% 50V
R773	1-249-413-11	CARBON 470 5%	1/4W	C942	1-102-123-00	CERAMIC 0.0033MF	10% 50V
R774	1-249-401-11	CARBON 47 5%	1/4W	C943	1-102-123-00	CERAMIC 0.0033MF	10% 50V
R776	1-247-807-31	CARBON 100 5%	1/4W	C1701	1-124-907-11	ELECT 10MF	20% 50V
R777	1-249-403-11	CARBON 68 5%	1/4W	C1702	1-124-907-11	ELECT 10MF	20% 50V
R778	1-249-412-11	CARBON 390 5%	1/4W	C1703	1-124-907-11	ELECT 10MF	20% 50V
R779	1-249-415-11	CARBON 680 5%	1/4W	C1704	1-124-667-11	ELECT 10MF	20% 50V
R780	1-247-807-31	CARBON 100 5%	1/4W	C1705	1-102-963-00	CERAMIC 33PF	5% 50V
R781	1-249-409-11	CARBON 220 5%	1/4W	C1706	1-102-963-00	CERAMIC 33PF	5% 50V
R782	1-215-423-00	METAL 1.2K 1%	1/4W	C1707	1-102-963-00	CERAMIC 33PF	5% 50V
R783	1-215-433-00	METAL 3.3K 1%	1/4W	C1708	1-102-963-00	CERAMIC 33PF	5% 50V
R784	1-215-429-00	METAL 2.2K 1%	1/4W	C1709	1-102-963-00	CERAMIC 33PF	5% 50V
R785	1-215-418-00	METAL 750 1%	1/4W	C1710	1-102-963-00	CERAMIC 33PF	5% 50V
<SPARK GAP>				C1711	1-126-233-11	ELECT 22MF	20% 50V
SG761	1-519-422-11	GAP, SPARK		C1712	1-126-233-11	ELECT 22MF	20% 25V
SG762	1-519-422-11	GAP, SPARK		C1713	1-131-353-00	TANTALUM 10MF	10% 25V
*****				C1714	1-124-120-11	ELECT 220MF	20% 25V
*****				C1715	1-124-478-11	ELECT 100MF	20% 25V
*****				C1716	1-126-803-11	ELECT 47MF	20% 25V
*****				C1717	1-126-803-11	ELECT 47MF	20% 25V
*****				C1718	1-131-353-00	TANTALUM 10MF	10% 25V
*****				C1719	1-126-233-11	ELECT 22MF	20% 25V
*****				C1720	1-130-491-00	MYLAR 0.047MF	5% 50V
*****				C1721	1-130-491-00	MYLAR 0.047MF	5% 50V
*****				C1722	1-130-491-00	MYLAR 0.047MF	5% 50V

D

Les composants identifiés par une trame et par une marque Δ sont d'une importance critique pour la sécurité. Ne les remplacer que par des pièces de numéro spécifié.

The components identified by shading and mark Δ are critical for safety. Replace only with part number specified.

REF. NO.	PART NO.	DESCRIPTION	REMARK	REF. NO.	PART NO.	DESCRIPTION	REMARK
C1725	1-102-963-00	CERAMIC	33PF	5%	50V		
C1726	1-124-122-11	ELECT	100MF	20%	35V		
C1727	1-102-963-00	CERAMIC	33PF	5%	50V		
C1728	1-102-963-00	CERAMIC	33PF	5%	50V		
C1729	1-106-377-00	MYLAR	0.027MF		200V		
C1730	1-102-963-00	CERAMIC	33PF	5%	50V		
C1731	1-124-122-11	ELECT	100MF	20%	35V		
C1732	1-106-377-00	MYLAR	0.027MF		200V		
C1733	1-102-963-00	CERAMIC	33PF	5%	50V		
C1734	1-102-963-00	CERAMIC	33PF	5%	50V		
C1735	1-124-122-11	ELECT	100MF	20%	35V		
C1736	1-106-377-00	MYLAR	0.027MF		200V		
C1737	1-124-937-11	ELECT	10MF	20%	16V		
C1738	1-124-122-11	ELECT	100MF	20%	35V		
C1739	1-136-153-00	FILM	0.01MF	5%	50V		
C1740	1-124-122-11	ELECT	100MF	20%	35V		
C1741	1-124-122-11	ELECT	100MF	20%	35V		
C1742	1-126-104-11	ELECT	470MF	20%	35V		
C1744	1-124-120-11	ELECT	220MF	20%	25V		
C1745	1-126-375-11	ELECT	100MF	20%	25V		
C1755	1-106-220-00	MYLAR	0.1MF	10%	100V		
C1756	1-106-220-00	MYLAR	0.1MF	10%	100V		
C1757	1-106-220-00	MYLAR	0.1MF	10%	100V		
C1758	1-106-220-00	MYLAR	0.1MF	10%	100V		
C1759	1-106-220-00	MYLAR	0.1MF	10%	100V		
C1760	1-106-220-00	MYLAR	0.1MF	10%	100V		
C1763	1-124-907-11	ELECT	10MF	20%	50V		
C1764	1-124-477-11	ELECT	47MF	20%	16V		
C1765	1-124-477-11	ELECT	47MF	20%	16V		
C1766	1-126-101-11	ELECT	100MF	20%	16V		
C1769	1-124-907-11	ELECT	10MF	20%	50V		
C1770	1-130-495-00	MYLAR	0.1MF	5%	50V		
C1771	1-124-907-11	ELECT	10MF	20%	50V		
C1772	1-124-907-11	ELECT	10MF	20%	50V		
C1861	1-102-074-00	CERAMIC	0.001MF	10%	50V		
C1924	1-126-233-11	ELECT	22MF	20%	25V		
<DIODE>							
D901	8-719-911-19	DIODE	ISS119				
D902	8-719-911-19	DIODE	ISS119				
D1702	8-719-911-19	DIODE	ISS119				
D1704	8-719-900-95	DIODE	V09G				
D1705	8-719-900-95	DIODE	V09G				
D1706	8-719-900-95	DIODE	V09G				
D1707	8-719-911-19	DIODE	ISS119				
D1708	8-719-911-19	DIODE	ISS119				
D1709	8-719-911-19	DIODE	ISS119				
D1710	8-719-911-19	DIODE	ISS119				
D1711	8-719-911-19	DIODE	ISS119				
D1712	8-719-911-19	DIODE	ISS119				
D1713	8-719-911-19	DIODE	ISS119				
D1714	8-719-911-19	DIODE	ISS119				
D1715	8-719-911-19	DIODE	ISS119				
D1716	8-719-911-19	DIODE	ISS119				
D1717	8-719-911-19	DIODE	ISS119				
D1718	8-719-911-19	DIODE	ISS119				
D1720	8-719-109-50	DIODE	RD2.OESB1				
D1721	8-719-109-50	DIODE	RD2.OESB1				
D1722	8-719-109-50	DIODE	RD2.OESB1				
D1723	8-719-109-50	DIODE	RD2.OESB1				
<CONNECTOR>							
D-1	*1-564-510-11	PLUG, CONNECTOR	7P				
D-2	*1-564-511-51	PLUG, CONNECTOR	8P				
D-3	*1-564-512-11	PLUG, CONNECTOR	9P				
D-4	*1-564-508-11	PLUG, CONNECTOR	5P				
D-5	*1-564-511-51	PLUG, CONNECTOR	8P				
D-6	1-691-169-11	PIN, CONNECTOR	12P				
D-7	*1-564-507-11	PLUG, CONNECTOR	4P				
D-8	*1-564-506-11	PLUG, CONNECTOR	3P				
D-9	*1-564-507-11	PLUG, CONNECTOR	4P				
D-14	*1-564-513-11	PLUG, CONNECTOR	10P				
<FUSE>							
F901	Δ 1-576-107-22	FUSE	3.15A/250V				
	1-533-223-11	CLIP, FUSE; F901					
F902	Δ 1-576-107-22	FUSE	3.15A/250V				
	1-533-223-11	CLIP, FUSE; F902					
<IC>							
IC901	8-759-145-58	IC	UPC4558C				
IC902	8-752-033-68	IC	CXA1268P				
IC903	8-759-701-56	IC	NJM78M05FA				
IC904	8-759-701-65	IC	NJM79M05FA				
IC905	8-759-701-89	IC	NJM7915FA				
IC906	8-759-148-84	IC	UPC2415HF				
IC907	8-759-140-53	IC	UPD4053BC				
IC908	8-759-145-58	IC	UPC4558C				
IC910	8-759-054-40	IC	PA0036				
IC1701	8-759-602-19	IC	M5220L				
IC1702	8-759-602-19	IC	M5220L				
IC1703	8-759-602-19	IC	M5220L				
IC1704	8-749-923-16	IC	STK4278-L				
IC1705	8-749-923-16	IC	STK4278-L				
IC1706	8-759-113-13	IC	UPC1498H				
IC1707	8-759-113-13	IC	UPC1498H				
IC1708	8-759-113-13	IC	UPC1498H				
IC1709	8-759-145-58	IC	UPC4558C				
IC1710	8-759-145-58	IC	UPC4558C				
IC1714	8-759-145-58	IC	UPC4558C				
IC1715	8-759-145-58	IC	UPC4558C				
IC1718	8-759-145-58	IC	UPC4558C				
<COIL>							
L901	1-459-313-00	COIL WITH CORE	(HWC)				
L902	1-459-313-00	COIL WITH CORE	(HWC)				
L903	1-459-313-00	COIL WITH CORE	(HWC)				
L904	1-459-313-00	COIL WITH CORE	(HWC)				
<TRANSISTOR>							
Q902	8-729-900-89	TRANSISTOR	DTC144ES				
Q906	8-729-119-78	TRANSISTOR	2SC2785-HFE				
Q907	8-729-119-78	TRANSISTOR	2SC2785-HFE				
Q908	8-729-900-89	TRANSISTOR	DTC144ES				
Q909	8-729-119-78	TRANSISTOR	2SC2785-HFE				
Q910	8-729-119-78	TRANSISTOR	2SC2785-HFE				
Q911	8-729-119-76	TRANSISTOR	2SA1175-HFE				
Q912	8-729-119-76	TRANSISTOR	2SA1175-HFE				
<RESISTOR>							
R901	1-215-463-00	METAL	56K	1%	1/4W		

The components identified by shading and mark Δ are critical for safety. Replace only with part number specified.

Les composants identifiés par une trame et par une marque Δ sont d'une importance critique pour la sécurité. Ne les remplacer que par des pièces de numéro spécifié.

D

REF.NO.	PART NO.	DESCRIPTION	REMARK	REF.NO.	PART NO.	DESCRIPTION	REMARK
R902	1-215-463-00	METAL	56K 1% 1/4W	R967	1-215-421-00	METAL	1K 1% 1/4W
R903	1-215-449-00	METAL	15K 1% 1/4W	R968	1-215-437-00	METAL	4.7K 1% 1/4W
R904	1-215-455-00	METAL	27K 1% 1/4W	R969	1-249-421-11	CARBON	2.2K 5% 1/4W
R905	1-215-449-00	METAL	15K 1% 1/4W	R970	Δ 1-215-909-71	METAL OXIDE	47 5% 3W F
R906	1-215-469-00	METAL	100K 1% 1/4W	R971	1-249-421-11	CARBON	2.2K 5% 1/4W
R907	1-215-469-00	METAL	100K 1% 1/4W	R972	1-249-431-11	CARBON	15K 5% 1/4W
R908	1-215-469-00	METAL	100K 1% 1/4W	R973	1-249-431-11	CARBON	15K 5% 1/4W
R909	1-215-473-00	METAL	150K 1% 1/4W	R974	1-215-399-00	METAL	120 1% 1/4W
R910	1-215-437-00	METAL	4.7K 1% 1/4W	R975	1-215-399-00	METAL	120 1% 1/4W
R911	1-215-453-00	METAL	22K 1% 1/4W	R976	1-215-399-00	METAL	120 1% 1/4W
R912	1-215-453-00	METAL	22K 1% 1/4W	R977	1-215-399-00	METAL	120 1% 1/4W
R913	1-215-437-00	METAL	4.7K 1% 1/4W	R978	1-215-399-00	METAL	120 1% 1/4W
R914	1-215-453-00	METAL	22K 1% 1/4W	R979	1-215-399-00	METAL	120 1% 1/4W
R915	1-215-421-00	METAL	1K 1% 1/4W	R980	1-215-399-00	METAL	120 1% 1/4W
R916	1-215-457-00	METAL	33K 1% 1/4W	R981	1-215-399-00	METAL	120 1% 1/4W
R917	1-215-453-00	METAL	22K 1% 1/4W	R982	1-249-431-11	CARBON	15K 5% 1/4W
R919	1-215-399-00	METAL	120 1% 1/4W	R983	1-249-431-11	CARBON	15K 5% 1/4W
R920	1-215-399-00	METAL	120 1% 1/4W	R984	1-214-804-11	METAL	3.3 1% 1/2W
R921	1-215-399-00	METAL	120 1% 1/4W	R985	1-214-804-11	METAL	3.3 1% 1/2W
R922	1-215-399-00	METAL	120 1% 1/4W	R986	1-214-804-11	METAL	3.3 1% 1/2W
R923	1-215-441-00	METAL	6.8K 1% 1/4W	R987	1-215-421-00	METAL	1K 1% 1/4W
R924	1-215-441-00	METAL	6.8K 1% 1/4W	R988	1-215-421-00	METAL	1K 1% 1/4W
R925	1-215-441-00	METAL	6.8K 1% 1/4W	R989	1-215-421-00	METAL	1K 1% 1/4W
R926	1-215-463-00	METAL	56K 1% 1/4W	R990	1-215-421-00	METAL	1K 1% 1/4W
R927	1-215-463-00	METAL	56K 1% 1/4W	R991	1-215-421-00	METAL	1K 1% 1/4W
R928	1-215-461-00	METAL	47K 1% 1/4W	R992	1-215-421-00	METAL	1K 1% 1/4W
R929	1-215-433-00	METAL	3.3K 1% 1/4W	R993	1-249-429-11	CARBON	10K 5% 1/4W
R930	1-215-433-00	METAL	3.3K 1% 1/4W	R994	1-249-429-11	CARBON	10K 5% 1/4W
R931	1-215-433-00	METAL	3.3K 1% 1/4W	R995	1-215-457-00	METAL	33K 1% 1/4W
R932	1-215-433-00	METAL	3.3K 1% 1/4W	R997	1-215-467-00	METAL	82K 1% 1/4W
R933	1-215-433-00	METAL	3.3K 1% 1/4W	R998	1-215-417-00	METAL	680 1% 1/4W
R934	1-215-433-00	METAL	3.3K 1% 1/4W	R999	1-215-455-00	METAL	27K 1% 1/4W
R935	1-215-439-00	METAL	5.6K 1% 1/4W	R1701	1-249-411-11	CARBON	330 5% 1/4W
R936	1-215-439-00	METAL	5.6K 1% 1/4W	R1702	1-249-427-11	CARBON	6.8K 5% 1/4W
R937	1-215-439-00	METAL	5.6K 1% 1/4W	R1703	1-249-427-11	CARBON	6.8K 5% 1/4W
R938	1-215-417-00	METAL	680 1% 1/4W	R1704	1-249-411-11	CARBON	330 5% 1/4W
R939	1-215-433-00	METAL	3.3K 1% 1/4W	R1705	1-249-411-11	CARBON	330 5% 1/4W
R940	1-215-429-00	METAL	2.2K 1% 1/4W	R1706	1-249-427-11	CARBON	6.8K 5% 1/4W
R941	1-215-441-00	METAL	6.8K 1% 1/4W	R1707	1-249-411-11	CARBON	330 5% 1/4W
R942	1-215-451-00	METAL	18K 1% 1/4W	R1708	1-249-427-11	CARBON	6.8K 5% 1/4W
R943	1-215-441-00	METAL	6.8K 1% 1/4W	R1709	1-249-427-11	CARBON	6.8K 5% 1/4W
R944	1-215-439-00	METAL	5.6K 1% 1/4W	R1710	1-249-411-11	CARBON	330 5% 1/4W
R945	1-215-445-00	METAL	10K 1% 1/4W	R1711	1-249-411-11	CARBON	330 5% 1/4W
R946	1-215-445-00	METAL	10K 1% 1/4W	R1712	1-249-427-11	CARBON	6.8K 5% 1/4W
R947	1-215-439-00	METAL	5.6K 1% 1/4W	R1713	Δ 1-215-886-71	METAL OXIDE	100 5% 2W F
R948	1-215-447-00	METAL	12K 1% 1/4W	R1714	1-249-411-11	CARBON	330 5% 1/4W
R949	1-215-439-00	METAL	5.6K 1% 1/4W	R1715	1-249-411-11	CARBON	330 5% 1/4W
R950	1-215-429-00	METAL	2.2K 1% 1/4W	R1716	Δ 1-215-886-71	METAL OXIDE	100 5% 2W F
R951	1-215-429-00	METAL	2.2K 1% 1/4W	R1717	1-249-411-11	CARBON	330 5% 1/4W
R952	1-215-429-00	METAL	2.2K 1% 1/4W	R1718	1-249-417-11	CARBON	1K 5% 1/4W
R953	1-215-439-00	METAL	5.6K 1% 1/4W	R1719	1-214-792-00	METAL	1 1% 1/2W
R954	1-215-439-00	METAL	5.6K 1% 1/4W	R1720	1-249-411-11	CARBON	330 5% 1/4W
R955	1-215-435-00	METAL	3.9K 1% 1/4W	R1721	1-249-417-11	CARBON	1K 5% 1/4W
R956	1-215-437-00	METAL	4.7K 1% 1/4W	R1722	1-249-411-11	CARBON	330 5% 1/4W
R957	1-215-441-00	METAL	6.8K 1% 1/4W	R1723	1-249-417-11	CARBON	1K 5% 1/4W
R958	1-215-437-00	METAL	4.7K 1% 1/4W	R1724	Δ 1-215-886-71	METAL OXIDE	100 5% 2W F
R959	1-215-439-00	METAL	5.6K 1% 1/4W	R1725	Δ 1-215-886-71	METAL OXIDE	100 5% 2W F
R960	1-215-439-00	METAL	5.6K 1% 1/4W	R1726	Δ 1-215-886-71	METAL OXIDE	100 5% 2W F
R961	1-215-439-00	METAL	5.6K 1% 1/4W	R1727	1-214-792-00	METAL	1 1% 1/2W
R962	1-215-441-00	METAL	6.8K 1% 1/4W	R1728	1-214-792-00	METAL	1 1% 1/2W
R963	1-215-441-00	METAL	6.8K 1% 1/4W	R1729	1-214-792-00	METAL	1 1% 1/2W
R964	1-215-441-00	METAL	6.8K 1% 1/4W	R1730	1-247-807-31	CARBON	100 5% 1/4W
R965	Δ 1-215-909-71	METAL OXIDE	47 5% 3W F	R1731	1-249-417-11	CARBON	1K 5% 1/4W
R966	1-215-469-00	METAL	100K 1% 1/4W				

D

Les composants identifiés par une trame et par une marque Δ sont d'une importance critique pour la sécurité. Ne les remplacer que par des pièces de numéro spécifié.

The components identified by shading and mark Δ are critical for safety. Replace only with part number specified.

REF. NO.	PART NO.	DESCRIPTION	REMARK	REF. NO.	PART NO.	DESCRIPTION	REMARK
R1732	1-247-807-31	CARBON	100 5% 1/4W	R1796	1-247-807-31	CARBON	100 5% 1/4W
R1733	1-247-807-31	CARBON	100 5% 1/4W	R1797	1-249-429-11	CARBON	10K 5% 1/4W
R1734	1-247-807-31	CARBON	100 5% 1/4W	R1798	1-249-423-11	CARBON	3.3K 5% 1/4W
R1735	1-247-807-31	CARBON	100 5% 1/4W	R1800	1-247-807-31	CARBON	100 5% 1/4W
R1736	1-249-423-11	CARBON	3.3K 5% 1/4W	R1801	1-215-439-00	METAL	5.6K 1% 1/4W
R1737	1-249-423-11	CARBON	3.3K 5% 1/4W	R1802	1-215-439-00	METAL	5.6K 1% 1/4W
R1738	1-249-423-11	CARBON	3.3K 5% 1/4W	R1803	1-215-439-00	METAL	5.6K 1% 1/4W
R1739	1-249-423-11	CARBON	3.3K 5% 1/4W	R1805	1-215-439-00	METAL	5.6K 1% 1/4W
R1740	1-249-417-11	CARBON	1K 5% 1/4W	R1806	1-247-807-31	CARBON	100 5% 1/4W
R1741	1-249-423-11	CARBON	3.3K 5% 1/4W	R1807	1-247-807-31	CARBON	100 5% 1/4W
R1742	1-249-423-11	CARBON	3.3K 5% 1/4W	R1808	1-214-792-00	METAL	1 1% 1/2W
R1743	1-249-417-11	CARBON	1K 5% 1/4W	R1809	1-214-792-00	METAL	1 1% 1/2W
R1744	1-249-411-11	CARBON	330 5% 1/4W	R1810	1-214-792-00	METAL	1 1% 1/2W
R1745	1-247-807-31	CARBON	100 5% 1/4W	R1811	1-214-792-00	METAL	1 1% 1/2W
R1746	1-214-792-00	METAL	1 1% 1/2W	R1812	1-214-792-00	METAL	1 1% 1/2W
R1747 Δ	1-215-886-71	METAL OXIDE	100 5% 2W F	R1813	1-214-792-00	METAL	1 1% 1/2W
R1748	1-215-421-00	METAL	1K 1% 1/4W	R1814	1-249-431-11	CARBON	15K 5% 1/4W
R1749	1-215-421-00	METAL	1K 1% 1/4W	R1815	1-247-885-00	CARBON	180K 5% 1/4W
R1750	1-215-421-00	METAL	1K 1% 1/4W	R1816	1-249-431-11	CARBON	15K 5% 1/4W
R1751	1-215-421-00	METAL	1K 1% 1/4W	R1817	1-247-885-00	CARBON	180K 5% 1/4W
R1752	1-215-421-00	METAL	1K 1% 1/4W	R1818	1-247-807-31	CARBON	100 5% 1/4W
R1753	1-215-421-00	METAL	1K 1% 1/4W	R1819	1-215-437-00	METAL	4.7K 1% 1/4W
R1754	1-214-792-00	METAL	1 1% 1/2W	R1820	1-215-437-00	METAL	4.7K 1% 1/4W
R1755	1-215-469-00	METAL	100K 1% 1/4W	R1821	1-215-437-00	METAL	4.7K 1% 1/4W
R1756	1-215-443-00	METAL	8.2K 1% 1/4W	R1822	1-215-445-00	METAL	10K 1% 1/4W
R1757	1-215-437-00	METAL	4.7K 1% 1/4W	R1823	1-215-445-00	METAL	10K 1% 1/4W
R1758	1-215-437-00	METAL	4.7K 1% 1/4W	R1824	1-215-433-00	METAL	3.3K 1% 1/4W
R1759	1-247-807-31	CARBON	100 5% 1/4W	R1825	1-215-433-00	METAL	3.3K 1% 1/4W
R1760	1-249-427-11	CARBON	6.8K 5% 1/4W	R1826	1-215-433-00	METAL	3.3K 1% 1/4W
R1761	1-249-419-11	CARBON	1.5K 5% 1/4W	R1827	1-215-445-00	METAL	10K 1% 1/4W
R1762	1-215-445-00	METAL	10K 1% 1/4W	R1828	1-215-445-00	METAL	10K 1% 1/4W
R1763	1-249-427-11	CARBON	6.8K 5% 1/4W	R1829	1-249-434-11	CARBON	27K 5% 1/4W
R1764	1-249-419-11	CARBON	1.5K 5% 1/4W	R1830	1-249-434-11	CARBON	27K 5% 1/4W
R1765	1-249-419-11	CARBON	1.5K 5% 1/4W	R1831	1-247-807-31	CARBON	100 5% 1/4W
R1766	1-249-427-11	CARBON	6.8K 5% 1/4W	R1832	1-215-471-00	METAL	120K 1% 1/4W
R1767	1-249-427-11	CARBON	6.8K 5% 1/4W	R1833	1-215-471-00	METAL	120K 1% 1/4W
R1768	1-249-439-11	CARBON	68K 5% 1/4W	R1834	1-215-471-00	METAL	120K 1% 1/4W
R1769	1-215-445-00	METAL	10K 1% 1/4W	R1835	1-215-437-00	METAL	4.7K 1% 1/4W
R1770	1-247-807-31	CARBON	100 5% 1/4W	R1836	1-215-437-00	METAL	4.7K 1% 1/4W
R1771	1-247-807-31	CARBON	100 5% 1/4W	R1837	1-215-421-00	METAL	1K 1% 1/4W
R1772	1-215-429-00	METAL	2.2K 1% 1/4W	R1838	1-249-431-11	CARBON	15K 5% 1/4W
R1773	1-215-429-00	METAL	2.2K 1% 1/4W	R1839	1-249-431-11	CARBON	15K 5% 1/4W
R1774	1-215-421-00	METAL	1K 1% 1/4W	R1858	1-215-445-00	METAL	10K 1% 1/4W
R1775	1-249-429-11	CARBON	10K 5% 1/4W	R1859	1-215-445-00	METAL	10K 1% 1/4W
R1776	1-215-421-00	METAL	1K 1% 1/4W	R1860	1-215-397-00	METAL	100 1% 1/4W
R1777	1-249-423-11	CARBON	3.3K 5% 1/4W	R1861	1-215-453-00	METAL	22K 1% 1/4W
R1778	1-215-421-00	METAL	1K 1% 1/4W	R1862	1-215-453-00	METAL	22K 1% 1/4W
R1779 Δ	1-215-898-71	METAL OXIDE	10K 5% 2W F	R1863	1-215-397-00	METAL	100 1% 1/4W
R1780	1-214-804-11	METAL	3.3 1% 1/2W	R1864	1-215-437-00	METAL	4.7K 1% 1/4W
R1781	1-214-804-11	METAL	3.3 1% 1/2W	R1865	1-215-453-00	METAL	22K 1% 1/4W
R1782 Δ	1-215-898-71	METAL OXIDE	10K 5% 2W F	R1866	1-215-453-00	METAL	22K 1% 1/4W
R1783	1-214-804-11	METAL	3.3 1% 1/2W	R1867	1-215-437-00	METAL	4.7K 1% 1/4W
R1784	1-214-804-11	METAL	3.3 1% 1/2W	R1868	1-215-449-00	METAL	15K 1% 1/4W
R1785 Δ	1-215-898-71	METAL OXIDE	10K 5% 2W F	R1869	1-215-445-00	METAL	10K 1% 1/4W
R1786	1-214-804-11	METAL	3.3 1% 1/2W	R1870	1-215-445-00	METAL	10K 1% 1/4W
R1787	1-214-804-11	METAL	3.3 1% 1/2W	R1871	1-215-445-00	METAL	10K 1% 1/4W
R1788	1-249-433-11	CARBON	22K 5% 1/4W	R1872	1-215-437-00	METAL	4.7K 1% 1/4W
R1789	1-249-441-11	CARBON	100K 5% 1/4W	R1873	1-215-437-00	METAL	4.7K 1% 1/4W
R1790	1-249-433-11	CARBON	22K 5% 1/4W	R1874	1-215-437-00	METAL	4.7K 1% 1/4W
R1791	1-249-429-11	CARBON	10K 5% 1/4W	R1875	1-215-437-00	METAL	4.7K 1% 1/4W
R1792	1-215-445-00	METAL	10K 1% 1/4W	R1876	1-215-437-00	METAL	4.7K 1% 1/4W
R1793	1-247-807-31	CARBON	100 5% 1/4W	R1877	1-215-437-00	METAL	4.7K 1% 1/4W
R1794	1-215-429-00	METAL	2.2K 1% 1/4W	R1878	1-215-475-00	METAL	180K 1% 1/4W
R1795	1-249-433-11	CARBON	22K 5% 1/4W				



REF. NO.	PART NO.	DESCRIPTION	REMARK	REF. NO.	PART NO.	DESCRIPTION	REMARK
R1879	1-215-475-00	METAL	180K 1% 1/4W	RV914	1-241-630-11	RES, ADJ, CARBON 10K	
R1880	1-215-475-00	METAL	180K 1% 1/4W	RV915	1-241-630-11	RES, ADJ, CARBON 10K	
R1881	1-215-461-00	METAL	47K 1% 1/4W	RV916	1-241-765-11	RES, ADJ, CARBON 22K	
R1882	1-215-445-00	METAL	10K 1% 1/4W	RV917	1-241-765-11	RES, ADJ, CARBON 22K	
R1883	1-215-453-00	METAL	22K 1% 1/4W	RV918	1-241-765-11	RES, ADJ, CARBON 22K	
R1884	1-215-397-00	METAL	100 1% 1/4W	RV919	1-241-765-11	RES, ADJ, CARBON 22K	
R1885	1-215-445-00	METAL	10K 1% 1/4W	RV920	1-241-765-11	RES, ADJ, CARBON 22K	
R1886	1-215-455-00	METAL	27K 1% 1/4W	RV921	1-241-765-11	RES, ADJ, CARBON 22K	
R1887	1-215-397-00	METAL	100 1% 1/4W	RV922	1-241-765-11	RES, ADJ, CARBON 22K	
R1888	1-215-461-00	METAL	47K 1% 1/4W	RV923	1-241-765-11	RES, ADJ, CARBON 22K	
R1889	1-215-457-00	METAL	33K 1% 1/4W	RV924	1-241-765-11	RES, ADJ, CARBON 22K	
R1890	1-215-449-00	METAL	15K 1% 1/4W	RV925	1-241-765-11	RES, ADJ, CARBON 22K	
R1891	1-215-443-00	METAL	8.2K 1% 1/4W	RV926	1-241-765-11	RES, ADJ, CARBON 22K	
R1892	1-215-445-00	METAL	10K 1% 1/4W	RV927	1-241-765-11	RES, ADJ, CARBON 22K	
R1894	1-215-429-00	METAL	2.2K 1% 1/4W	RV928	1-241-630-11	RES, ADJ, CARBON 10K	
R1895	1-215-445-00	METAL	10K 1% 1/4W	RV929	1-241-765-11	RES, ADJ, CARBON 22K	
R1896	1-215-445-00	METAL	10K 1% 1/4W	RV930	1-241-630-11	RES, ADJ, CARBON 10K	
R1897	1-215-449-00	METAL	15K 1% 1/4W	RV931	1-241-765-11	RES, ADJ, CARBON 22K	
R1898	1-215-445-00	METAL	10K 1% 1/4W	RV932	1-241-765-11	RES, ADJ, CARBON 22K	
R1899	1-215-421-00	METAL	1K 1% 1/4W	RV933	1-241-765-11	RES, ADJ, CARBON 22K	
R1900	1-215-429-00	METAL	2.2K 1% 1/4W	RV934	1-241-765-11	RES, ADJ, CARBON 22K	
R1901	1-215-449-00	METAL	15K 1% 1/4W	RV935	1-241-765-11	RES, ADJ, CARBON 22K	
R1902	1-215-445-00	METAL	10K 1% 1/4W	RV936	1-241-765-11	RES, ADJ, CARBON 22K	
R1903	1-215-445-00	METAL	10K 1% 1/4W	RV937	1-241-630-11	RES, ADJ, CARBON 10K	
R1904	1-215-445-00	METAL	10K 1% 1/4W	RV938	1-241-630-11	RES, ADJ, CARBON 10K	
R1905	1-215-445-00	METAL	10K 1% 1/4W	RV939	1-241-630-11	RES, ADJ, CARBON 10K	
R1906	1-215-429-00	METAL	2.2K 1% 1/4W	RV940	1-241-765-11	RES, ADJ, CARBON 22K	
R1907	1-215-445-00	METAL	10K 1% 1/4W	RV941	1-241-765-11	RES, ADJ, CARBON 22K	
R1908	1-215-445-00	METAL	10K 1% 1/4W	RV942	1-241-765-11	RES, ADJ, CARBON 22K	
R1909	1-215-445-00	METAL	10K 1% 1/4W	RV943	1-241-765-11	RES, ADJ, CARBON 22K	
R1910	1-215-445-00	METAL	10K 1% 1/4W	RV944	1-241-765-11	RES, ADJ, CARBON 22K	
R1911	1-215-453-00	METAL	22K 1% 1/4W	RV945	1-241-765-11	RES, ADJ, CARBON 22K	
R1916	1-215-423-00	METAL	1.2K 1% 1/4W	RV946	1-241-765-11	RES, ADJ, CARBON 22K	
R1920	1-215-453-00	METAL	22K 1% 1/4W	RV947	1-241-765-11	RES, ADJ, CARBON 22K	
R1921	1-215-445-00	METAL	10K 1% 1/4W	RV948	1-241-765-11	RES, ADJ, CARBON 22K	
R1922	1-215-445-00	METAL	10K 1% 1/4W	RV949	1-241-765-11	RES, ADJ, CARBON 22K	
R1924	1-215-429-00	METAL	2.2K 1% 1/4W	RV950	1-241-765-11	RES, ADJ, CARBON 22K	
R1925	1-215-429-00	METAL	2.2K 1% 1/4W	RV951	1-241-765-11	RES, ADJ, CARBON 22K	
R1926	1-215-429-00	METAL	2.2K 1% 1/4W	RV952	1-241-765-11	RES, ADJ, CARBON 22K	
R1927	1-215-445-00	METAL	10K 1% 1/4W	RV953	1-241-765-11	RES, ADJ, CARBON 22K	
R1928	1-215-421-00	METAL	1K 1% 1/4W	RV954	1-241-765-11	RES, ADJ, CARBON 22K	
R1929	1-215-445-00	METAL	10K 1% 1/4W	RV956	1-241-765-11	RES, ADJ, CARBON 22K	
R1930	1-215-397-00	METAL	100 1% 1/4W	RV958	1-241-765-11	RES, ADJ, CARBON 22K	
R1931	1-215-397-00	METAL	100 1% 1/4W	RV959	1-241-765-11	RES, ADJ, CARBON 22K	
R1932	1-215-453-00	METAL	22K 1% 1/4W	RV961	1-241-765-11	RES, ADJ, CARBON 22K	
R1933	1-215-453-00	METAL	22K 1% 1/4W	RV962	1-241-765-11	RES, ADJ, CARBON 22K	
R1934	1-215-429-00	METAL	2.2K 1% 1/4W	RV963	1-241-765-11	RES, ADJ, CARBON 22K	
R1937	1-215-445-00	METAL	10K 1% 1/4W	RV964	1-241-765-11	RES, ADJ, CARBON 22K	
<VARIABLE RESISTOR>							
RV901	1-241-765-11	RES, ADJ, CARBON 22K		RV965	1-241-765-11	RES, ADJ, CARBON 22K	
RV902	1-241-765-11	RES, ADJ, CARBON 22K		RV966	1-241-765-11	RES, ADJ, CARBON 22K	
RV903	1-241-765-11	RES, ADJ, CARBON 22K		RV967	1-241-765-11	RES, ADJ, CARBON 22K	
RV904	1-241-765-11	RES, ADJ, CARBON 22K		RV968	1-241-765-11	RES, ADJ, CARBON 22K	
RV905	1-241-765-11	RES, ADJ, CARBON 22K		RV969	1-241-765-11	RES, ADJ, CARBON 22K	
RV906	1-241-765-11	RES, ADJ, CARBON 22K		RV970	1-241-765-11	RES, ADJ, CARBON 22K	
RV907	1-241-765-11	RES, ADJ, CARBON 22K		RV971	1-241-765-11	RES, ADJ, CARBON 22K	
RV908	1-241-765-11	RES, ADJ, CARBON 22K		RV972	1-241-765-11	RES, ADJ, CARBON 22K	
RV909	1-241-765-11	RES, ADJ, CARBON 22K		RV973	1-241-765-11	RES, ADJ, CARBON 22K	
RV910	1-241-765-11	RES, ADJ, CARBON 22K		RV974	1-241-765-11	RES, ADJ, CARBON 22K	
RV911	1-241-761-11	RES, ADJ, CARBON 1K		RV975	1-241-765-11	RES, ADJ, CARBON 22K	
RV912	1-241-765-11	RES, ADJ, CARBON 22K		RV976	1-241-765-11	RES, ADJ, CARBON 22K	
RV913	1-241-769-11	RES, ADJ, CARBON 470K		RV977	1-241-765-11	RES, ADJ, CARBON 22K	
				RV978	1-241-765-11	RES, ADJ, CARBON 22K	
				RV979	1-241-765-11	RES, ADJ, CARBON 22K	

D **DS** **V**

REF. NO.	PART NO.	DESCRIPTION	REMARK	REF. NO.	PART NO.	DESCRIPTION	REMARK
RV980	1-238-019-11	RES, ADJ, CARBON 47K		C1534	1-101-003-00	CERAMIC	0.0047MF 50V
RV981	1-241-765-11	RES, ADJ, CARBON 22K		C1551	1-124-122-11	ELECT	100MF 20% 50V
RV982	1-241-765-11	RES, ADJ, CARBON 22K		C1552	1-124-122-11	ELECT	100MF 20% 50V
*****				C1553	1-102-824-00	CERAMIC	470PF 5% 50V
*****				C1554	1-102-824-00	CERAMIC	470PF 5% 50V
*1-650-883-11 DS BOARD				C1555	1-130-483-00	MYLAR	0.01MF 5% 50V
*****				C1556	1-130-483-00	MYLAR	0.01MF 5% 50V
<CAPACITOR>				C1557	1-102-824-00	CERAMIC	470PF 5% 50V
C1841	1-126-233-11	ELECT	22MF 20% 25V	C1558	1-102-824-00	CERAMIC	470PF 5% 50V
C1842	1-126-233-11	ELECT	22MF 20% 25V	C1559	1-102-824-00	CERAMIC	470PF 5% 50V
<DIODE>				C1560	1-102-824-00	CERAMIC	470PF 5% 50V
D1841	8-719-911-19	DIODE 1SS119		C1561	1-130-483-00	MYLAR	0.01MF 5% 50V
D1842	8-719-911-19	DIODE 1SS119		C1562	1-130-483-00	MYLAR	0.01MF 5% 50V
D1843	8-719-911-19	DIODE 1SS119		C1563	1-130-483-00	MYLAR	0.01MF 5% 50V
D1844	8-719-911-19	DIODE 1SS119		<DIODE>			
<CONNECTOR>				D1501	8-719-911-19	DIODE 1SS119	
DS-6	1-691-182-11	CONNECTOR (BOARD TO BOARD) 12P		D1502	8-719-911-19	DIODE 1SS119	
<IC>				D1503	8-719-911-19	DIODE 1SS119	
IC1801	8-759-183-37	IC CA0007AD		D1504	8-719-911-19	DIODE 1SS119	
<RESISTOR>				D1505	8-719-911-19	DIODE 1SS119	
R1841	1-215-441-00	METAL	6.8K 1% 1/4W	D1506	8-719-911-19	DIODE 1SS119	
R1842	1-215-455-00	METAL	27K 1% 1/4W	D1507	8-719-110-88	DIODE RD39ESB2	
R1844	1-215-445-00	METAL	10K 1% 1/4W	D1508	8-719-110-88	DIODE RD39ESB2	
R1850	1-215-429-00	METAL	2.2K 1% 1/4W	D1509	8-719-911-19	DIODE 1SS119	
R1851	1-215-421-00	METAL	1K 1% 1/4W	<IC>			
*****				IC1551	8-759-145-58	IC UPC4558C	
*****				IC1552	8-759-912-77	IC LM324N	
*A-1342-214-A V BOARD, COMPLETE				<COIL>			
*****				L1502	1-408-418-00	INDUCTOR	56UH
4-382-854-11 SCREW (M3X10), P, SW (+)				<TRANSISTOR>			
<CAPACITOR>				Q1501	8-729-017-05	TRANSISTOR 2SA1837	
C1501	1-102-129-00	CERAMIC	0.01MF 10% 50V	Q1502	8-729-017-06	TRANSISTOR 2SC4793	
C1502	1-126-101-11	ELECT	100MF 20% 16V	Q1503	8-729-119-78	TRANSISTOR 2SC2785-HFE	
C1504	1-106-383-00	MYLAR	0.047MF 200V	Q1504	8-729-119-78	TRANSISTOR 2SC2785-HFE	
C1505	1-124-907-11	ELECT	10MF 20% 50V	Q1505	8-729-119-76	TRANSISTOR 2SA1175-HFE	
C1506	1-106-359-00	MYLAR	0.0047MF 10% 200V	Q1506	8-729-119-78	TRANSISTOR 2SC2785-HFE	
C1507	1-106-367-00	MYLAR	0.01MF 10% 100V	Q1507	8-729-119-78	TRANSISTOR 2SC2785-HFE	
C1508	1-162-318-11	CERAMIC	0.001MF 10% 500V	Q1508	8-729-142-86	TRANSISTOR 2SC3733	
C1509	1-106-367-00	MYLAR	0.01MF 10% 100V	Q1551	8-729-231-60	TRANSISTOR 2SD1406-YGR	
C1510	1-126-355-11	ELECT	33MF 20% 160V	Q1552	8-729-141-83	TRANSISTOR 2SB1094-LK	
C1511	1-124-668-11	ELECT	2.2MF 20% 200V	Q1553	8-729-231-60	TRANSISTOR 2SD1406-YGR	
C1512	1-106-391-12	MYLAR	0.1MF 10% 200V	Q1554	8-729-141-83	TRANSISTOR 2SB1094-LK	
C1513	1-162-318-11	CERAMIC	0.001MF 10% 500V	Q1555	8-729-231-60	TRANSISTOR 2SD1406-YGR	
C1514	1-102-951-00	CERAMIC	15PF 5% 50V	Q1556	8-729-141-83	TRANSISTOR 2SB1094-LK	
C1515	1-102-959-00	CERAMIC	22PF 5% 50V	<RESISTOR>			
C1516	1-102-963-00	CERAMIC	33PF 5% 50V	R1501	1-249-451-11	CARBON	2.2 5% 1/4W F
C1517	1-124-667-11	ELECT	10MF 20% 50V	R1502	1-249-414-11	CARBON	560 5% 1/4W F
C1518	1-102-074-00	CERAMIC	0.001MF 10% 50V	R1503	1-247-734-11	CARBON	39 5% 1/2W F
C1519	1-106-359-00	MYLAR	0.0047MF 10% 200V	R1504	1-249-384-11	CARBON	1.8 5% 1/4W F
C1520	1-126-803-11	ELECT	47MF 20% 16V	R1505	1-247-807-31	CARBON	100 5% 1/4W
C1521	1-124-907-11	ELECT	10MF 20% 50V	R1506	1-249-419-11	CARBON	1.5K 5% 1/4W
				R1507	1-249-412-11	CARBON	390 5% 1/4W
				R1508	1-249-436-11	CARBON	39K 5% 1/4W
				R1509	1-249-421-11	CARBON	2.2K 5% 1/4W
				R1510	1-249-436-11	CARBON	39K 5% 1/4W

The components identified by shading and mark Δ are critical for safety. Replace only with part number specified.

Les composants identifiés par une trame et par une marque Δ sont d'une importance critique pour la sécurité. Ne les remplacer que par des pièces de numéro spécifié.

V H1 H2

REF. NO.	PART NO.	DESCRIPTION	REMARK	REF. NO.	PART NO.	DESCRIPTION	REMARK
R1511	1-249-418-11	CARBON	1.2K 5% 1/4W				
R1512	1-249-441-11	CARBON	100K 5% 1/4W				
R1513	1-249-432-11	CARBON	18K 5% 1/4W				
R1514	1-247-807-31	CARBON	100 5% 1/4W				
R1515	1-249-435-11	CARBON	33K 5% 1/4W				
R1517	1-247-713-11	CARBON	1K 5% 1/4W F				
R1519	1-215-916-91	METAL OXIDE	680 5% 3W F				
R1520	1-249-432-11	CARBON	18K 5% 1/4W				
R1521	1-249-414-11	CARBON	560 5% 1/4W F				
R1522	1-249-384-11	CARBON	1.8 5% 1/4W F				
R1523	1-249-400-11	CARBON	39 5% 1/4W F				
R1524	1-249-418-11	CARBON	1.2K 5% 1/4W				
R1525	1-249-421-11	CARBON	2.2K 5% 1/4W				
R1526	1-249-426-11	CARBON	5.6K 5% 1/4W				
R1527	1-249-414-11	CARBON	560 5% 1/4W				
R1528	1-249-429-11	CARBON	10K 5% 1/4W				
R1529	1-249-414-11	CARBON	560 5% 1/4W				
R1530	1-216-451-91	METAL OXIDE	120 5% 2W F				
R1531	1-249-429-11	CARBON	10K 5% 1/4W				
R1532	1-249-421-11	CARBON	2.2K 5% 1/4W				
R1533	1-247-903-00	CARBON	1M 5% 1/4W				
R1534	1-249-423-11	CARBON	3.3K 5% 1/4W				
R1535	1-249-392-11	CARBON	8.2 5% 1/4W F				
R1540	1-215-445-00	METAL	10K 1% 1/4W				
R1541	1-215-445-00	METAL	10K 1% 1/4W				
R1542	1-215-445-00	METAL	10K 1% 1/4W				
R1551	1-215-445-00	METAL	10K 1% 1/4W				
R1552	1-215-423-00	METAL	1.2K 1% 1/4W				
R1553	1-249-417-11	CARBON	1K 5% 1/4W				
R1554	1-215-445-00	METAL	10K 1% 1/4W				
R1555	1-215-375-00	METAL	12 1% 1/4W				
R1556	1-215-375-00	METAL	12 1% 1/4W				
R1557	1-215-375-00	METAL	12 1% 1/4W				
R1558	1-215-445-00	METAL	10K 1% 1/4W				
R1559	1-215-445-00	METAL	10K 1% 1/4W				
R1560	1-215-445-00	METAL	10K 1% 1/4W				
R1561	1-215-423-00	METAL	1.2K 1% 1/4W				
R1562	1-215-423-00	METAL	1.2K 1% 1/4W				
R1563	1-215-445-00	METAL	10K 1% 1/4W				
R1564	1-249-417-11	CARBON	1K 5% 1/4W				
R1565	1-215-445-00	METAL	10K 1% 1/4W				
R1566	1-215-375-00	METAL	12 1% 1/4W				
R1567	1-215-375-00	METAL	12 1% 1/4W				
R1568	1-215-375-00	METAL	12 1% 1/4W				
R1569	1-215-445-00	METAL	10K 1% 1/4W				
R1570	1-215-445-00	METAL	10K 1% 1/4W				
R1571	1-249-417-11	CARBON	1K 5% 1/4W				
R1572	1-215-445-00	METAL	10K 1% 1/4W				
R1573	1-215-375-00	METAL	12 1% 1/4W				
R1574	1-215-375-00	METAL	12 1% 1/4W				
R1575	1-215-375-00	METAL	12 1% 1/4W				
R1576	1-215-445-00	METAL	10K 1% 1/4W				
R1577	1-215-445-00	METAL	10K 1% 1/4W				
R1578	1-249-417-11	CARBON	1K 5% 1/4W				
R1579	1-249-417-11	CARBON	1K 5% 1/4W				
R1580	1-249-417-11	CARBON	1K 5% 1/4W				
R1581	1-249-432-11	CARBON	18K 5% 1/4W				
R1582	1-249-432-11	CARBON	18K 5% 1/4W				
<CONNECTOR>							
V2	*1-564-518-11	PLUG, CONNECTOR 3P					
V22	1-573-300-21	CONNECTOR, BOARD TO BOARD 18P					

	*1-643-591-11	H1 BOARD					

	4-033-777-01	HOLDER, LED					
	*4-374-987-01	GUIDE, LIGHT (KP-46XBR35/53XBR35(U/C))					
	4-381-686-01	BRACKET (B), LIGHT GUIDE					
	*4-389-517-01	GUIDE (R), LIGHT (KP-61XBR38)					
<CAPACITOR>							
C1601	1-124-907-11	ELECT	10MF 20% 50V				
C1602	1-124-907-11	ELECT	10MF 20% 50V				
C1603	1-124-907-11	ELECT	10MF 20% 50V				
C1604	1-124-261-00	ELECT	10MF 20% 50V				
<DIODE>							
D1601	8-719-812-41	DIODE TLR124					
D1602	8-719-812-41	DIODE TLR124					
<CONNECTOR>							
H11	*1-564-526-11	PLUG, CONNECTOR 11P					
H15	*1-564-517-11	PLUG, CONNECTOR 2P					
<IC>							
IC1601	8-741-148-33	IC SBX1483-59					
<RESISTOR>							
R1601	1-249-430-11	CARBON	12K 5% 1/4W				
R1602	1-249-425-11	CARBON	4.7K 5% 1/4W				
R1603	1-249-421-11	CARBON	2.2K 5% 1/4W				
R1604	1-249-419-11	CARBON	1.5K 5% 1/4W				
R1606	1-247-807-31	CARBON	100 5% 1/4W				
R1607	1-247-807-31	CARBON	100 5% 1/4W				
R1608	1-249-411-11	CARBON	330 5% 1/4W				
R1609	1-249-411-11	CARBON	330 5% 1/4W				
<SWITCH>							
S1601	1-571-731-11	SWITCH, TACTIL					
S1602	1-571-731-11	SWITCH, TACTIL					
S1603	1-571-731-11	SWITCH, TACTIL					
S1604	1-571-731-11	SWITCH, TACTIL					
S1605	1-571-731-11	SWITCH, TACTIL					
S1606	1-571-731-21	SWITCH, TACTIL					

	*1-643-592-11	H2 BOARD					

<CAPACITOR>							
C1651	1-124-477-11	ELECT	47MF 20% 16V				
C1655	1-124-927-11	ELECT	4.7MF 20% 50V				
<DIODE>							
D1651	8-719-908-03	DIODE GP08D					
D1652	8-719-908-03	DIODE GP08D					
D1653	8-719-108-12	DIODE RD9.1EW					

H2 **YA**

Les composants identifiés par une trame et par une marque **Δ** sont d'une importance critique pour la sécurité. Ne les remplacer que par des pièces de numéro spécifié.

The components identified by shading and mark **Δ** are critical for safety. Replace only with part number specified.

REF. NO.	PART NO.	DESCRIPTION	REMARK	REF. NO.	PART NO.	DESCRIPTION	REMARK
D1654	8-719-108-12	DIODE RD9.1EW					
D1655	8-719-108-12	DIODE RD9.1EW					
D1659	8-719-911-19	DIODE 1SS119					
D1660	8-719-110-88	DIODE RD39ESB2					
D1661	8-719-110-88	DIODE RD39ESB2					
D1662	8-719-110-88	DIODE RD39ESB2					
D1663	8-719-110-88	DIODE RD39ESB2					
<CONNECTOR>							
H22	*1-564-519-11	PLUG, CONNECTOR 4P					
H25	*1-564-517-11	PLUG, CONNECTOR 2P					
H26	*1-564-519-11	PLUG, CONNECTOR 4P					
H28	*1-564-518-11	PLUG, CONNECTOR 3P					
H211	1-564-517-11	PLUG, CONNECTOR 2P					
H216	*1-564-525-11	PLUG, CONNECTOR 10P					
H225	*1-564-518-11	PLUG, CONNECTOR 3P					
H2-20	*1-564-517-11	PLUG, CONNECTOR 2P					
H2-21	*1-564-517-11	PLUG, CONNECTOR 2P					
		(KP-46XBR35/53XBR35(U/C))					
	1-564-517-11	PLUG, CONNECTOR 2P (KP-61XBR38)					
<JACK>							
J1651	1-695-817-11	JACK BLOCK, PIN 3P					
<JUMPER>							
JW54	1-123-549-00	ELECT	6.8MF 20% 50V (KP-61XBR38)				
JW55	1-123-549-00	ELECT	6.8MF 20% 50V (KP-61XBR38)				
<TRANSISTOR>							
Q1651	8-729-119-78	TRANSISTOR 2SC2785-HFE					
Q1652	8-729-119-78	TRANSISTOR 2SC2785-HFE					
Q1653	8-729-119-78	TRANSISTOR 2SC2785-HFE					
<RESISTOR>							
R1651	1-249-419-11	CARBON	1.5K 5% 1/4W				
R1652	1-249-421-11	CARBON	2.2K 5% 1/4W				
R1653	1-249-425-11	CARBON	4.7K 5% 1/4W				
R1654	1-249-430-11	CARBON	12K 5% 1/4W				
R1655	1-249-417-11	CARBON	1K 5% 1/4W				
R1656	1-249-417-11	CARBON	1K 5% 1/4W				
R1657	1-249-436-11	CARBON	39K 5% 1/4W				
R1658	1-249-437-11	CARBON	47K 5% 1/4W				
R1659	1-249-437-11	CARBON	47K 5% 1/4W				
<RELAY>							
RY1651	1-515-586-11	RELAY (DS-2)					
RY1652	1-515-586-11	RELAY (DS-2)					
<SWITCH>							
S1651	1-571-731-11	SWITCH, TACTIL					
S1652	1-571-731-11	SWITCH, TACTIL					
S1653	1-571-731-11	SWITCH, TACTIL					
S1654	1-571-731-11	SWITCH, TACTIL					
S1655	1-571-731-11	SWITCH, TACTIL					
				*1-644-632-11 YA BOARD *****			
				<CAPACITOR>			
C7001	1-124-902-00	ELECT	0.47MF 20% 50V				
C7002	1-102-824-00	CERAMIC	470PF 5% 50V				
C7003	1-124-910-11	ELECT	47MF 20% 50V				
C7005	1-124-618-11	ELECT	2200MF 20% 35V				
C7006	1-137-399-11	FILM	0.1MF 5% 100V				
C7007	1-124-910-11	ELECT	47MF 20% 50V				
C7008	1-124-910-11	ELECT	47MF 20% 50V				
C7009	1-137-399-11	FILM	0.1MF 5% 100V				
C7010	1-124-618-11	ELECT	2200MF 20% 35V				
C7012	1-124-910-11	ELECT	47MF 20% 50V				
C7013	1-124-902-00	ELECT	0.47MF 20% 50V				
C7014	1-102-824-00	CERAMIC	470PF 5% 50V				
C7015	1-124-917-11	ELECT	33MF 20% 50V				
C7016	1-124-572-11	ELECT	100MF 20% 63V				
C7017	1-124-921-11	ELECT	470MF 20% 63V				
C7020	1-124-903-11	ELECT	1MF 20% 50V				
C7021	1-124-903-11	ELECT	1MF 20% 50V				
C7041	1-124-484-11	ELECT	220MF 20% 35V				
C7042	1-124-484-11	ELECT	220MF 20% 35V				
				<DIODE>			
D7041	8-719-946-29	DIODE 1SS198TA					
D7042	8-719-946-29	DIODE 1SS198TA					
				<IC>			
IC7001	8-749-920-14	IC STK4412					
				<TRANSISTOR>			
Q7001	8-729-141-26	TRANSISTOR 2SC3622A-LK					
Q7002	8-729-141-26	TRANSISTOR 2SC3622A-LK					
Q7041	8-729-141-26	TRANSISTOR 2SC3622A-LK					
				<RESISTOR>			
R7001	1-249-433-11	CARBON	22K 5% 1/4W				
R7002	1-249-433-11	CARBON	22K 5% 1/4W				
R7003	1-249-441-11	CARBON	100K 5% 1/4W				
R7006	1-249-430-11	CARBON	12K 5% 1/4W				
R7007	1-249-411-11	CARBON	330 5% 1/4W				
R7008	Δ 1-215-888-71	METAL OXIDE	220 5% 2W F				
R7009	1-249-389-11	CARBON	4.7 5% 1/4W F				
R7010	1-249-389-11	CARBON	4.7 5% 1/4W F				
R7011	Δ 1-215-888-71	METAL OXIDE	220 5% 2W F				
R7012	1-249-430-11	CARBON	12K 5% 1/4W				
R7014	1-249-411-11	CARBON	330 5% 1/4W				
R7016	1-249-441-11	CARBON	100K 5% 1/4W				
R7017	1-249-441-11	CARBON	100K 5% 1/4W				
R7018	1-247-889-00	CARBON	270K 5% 1/4W				
R7019	1-247-807-31	CARBON	100 5% 1/4W F				
R7023	1-215-445-00	METAL	10K 1% 1/4W				
R7024	1-215-445-00	METAL	10K 1% 1/4W				
R7030	1-215-439-00	METAL	5.6K 1% 1/4W				
R7031	1-215-439-00	METAL	5.6K 1% 1/4W				
R7041	1-247-895-00	CARBON	470K 5% 1/4W				
R7042	1-247-895-00	CARBON	470K 5% 1/4W				

The components identified by shading and mark Δ are critical for safety. Replace only with part number specified.

Les composants identifiés par une trame et par une marque Δ sont d'une importance critique pour la sécurité. Ne les remplacer que par des pièces de numéro spécifié.

YA **YG** **ZR** **ZG** **ZB** **N**

REF. NO.	PART NO.	DESCRIPTION	REMARK
R7043	1-247-893-11	CARBON 390K 5% 1/4W	
R7044	1-249-437-11	CARBON 47K 5% 1/4W	
R7100	Δ 1-217-286-11	WIREWOUND 1 10% 5W F	
R7101	Δ 1-217-288-11	WIREWOUND 1.5 10% 5W F	
R7102	Δ 1-217-288-11	WIREWOUND 1.5 10% 5W F	

<CONNECTOR>

YA2	*1-564-507-11	PLUG, CONNECTOR 4P
YA7	*1-564-505-11	PLUG, CONNECTOR 2P
YA8	*1-564-506-11	PLUG, CONNECTOR 3P
YA28	*1-564-508-11	PLUG, CONNECTOR 5P

*1-644-633-11 YG BOARD

1-533-189-11	HOLDER, FUSE
4-382-854-11	SCREW (M3X10), P, SW (+)

<CAPACITOR>

C7201	1-125-463-11	ELECT (BLOCK) 2200MF 20% 63V
C7202	1-124-607-11	ELECT 2200MF 20% 50V
C7203	1-101-821-00	CERAMIC 0.0022MF 500V
C7204	1-101-821-00	CERAMIC 0.0022MF 500V
C7205	1-101-821-00	CERAMIC 0.0022MF 500V
C7206	1-101-821-00	CERAMIC 0.0022MF 500V
C7207	1-161-743-00	CERAMIC 0.0047MF 400V

<DIODE>

D7201	8-719-110-30	DIODE RD12ESB1
D7202	Δ 8-719-312-09	DIODE RBA-402
D7203	Δ 8-719-312-09	DIODE RBA-402

<FUSE>

F7201	Δ 1-532-746-11	FUSE, GLASS TUBE 4A/125V
F7202	Δ 1-532-746-11	FUSE, GLASS TUBE 4A/125V

<RESISTOR>

R7201	1-249-406-11	CARBON 120 5% 1/4W F
R7202	Δ 1-215-879-71	METAL OXIDE 47K 5% 1W F
R7203	Δ 1-215-879-71	METAL OXIDE 47K 5% 1W F

<RELAY>

RY7201	Δ 1-515-684-12	RELAY
--------	-----------------------	-------

<CONNECTOR>

YG1	*1-691-134-11	PIN, CONNECTOR (PC BOARD) 2P
YG2	*1-564-507-11	PLUG, CONNECTOR 4P
YG3	*1-564-507-11	PLUG, CONNECTOR 4P
YG5	1-508-766-00	PIN, CONNECTOR (5MM PITCH) 4P
YG9	*1-508-765-00	PIN, CONNECTOR (5MM PITCH) 3P
YG12	1-564-505-11	PLUG, CONNECTOR 2P

*A-1390-340-A ZR BOARD, COMPLETE

REF. NO.	PART NO.	DESCRIPTION	REMARK
<RESISTOR>			
R1903	1-249-414-11	CARBON 560 5% 1/4W	
R1904	1-249-414-11	CARBON 560 5% 1/4W	

<CONNECTOR>

ZR2	*1-564-518-11	PLUG, CONNECTOR 3P
ZR18	*1-691-292-11	PIN, CONNECTOR (PC BOARD) 3P
ZR-1	*1-564-522-11	PLUG, CONNECTOR 7P

*A-1390-346-A ZG BOARD, COMPLETE

<RESISTOR>

R1913	1-249-414-11	CARBON 560 5% 1/4W
R1914	1-249-414-11	CARBON 560 5% 1/4W

<CONNECTOR>

ZG19	*1-691-292-11	PIN, CONNECTOR (PC BOARD) 3P
ZG-2	1-564-523-11	PLUG, CONNECTOR 8P

*A-1390-347-A ZB BOARD, COMPLETE

<RESISTOR>

R1923	1-249-414-11	CARBON 560 5% 1/4W
R1924	1-249-414-11	CARBON 560 5% 1/4W

<CONNECTOR>

ZB20	*1-691-292-11	PIN, CONNECTOR (PC BOARD) 3P
ZB-3	1-564-524-11	PLUG, CONNECTOR 9P

*A-1390-351-A N BOARD, COMPLETE

4-382-854-11	SCREW (M3X10), P, SW (+)
4-383-023-01	SPACER, MICA

<CAPACITOR>

C801	1-125-489-00	ELECT (BLOCK) 560MF 20% 200V
C802	1-123-024-21	ELECT 33MF 160V
C803	1-136-729-11	FILM 1.5MF 5% 400V
C804	1-106-383-00	MYLAR 0.047MF 200V
C805	1-102-030-00	CERAMIC 330PF 10% 500V
C806	1-130-495-00	MYLAR 0.1MF 5% 50V
C807	1-124-667-11	ELECT 10MF 20% 50V
C808	1-126-183-11	ELECT 1000MF 20% 16V
C809	1-124-903-11	ELECT 1MF 20% 50V
C810	1-124-903-11	ELECT 1MF 20% 50V
C811	1-124-902-00	ELECT 0.47MF 20% 50V
C812	1-102-973-00	CERAMIC 100PF 5% 50V
C813	1-102-244-00	CERAMIC 220PF 10% 500V
C814	1-106-391-12	MYLAR 0.1MF 10% 200V
C815	1-106-367-00	MYLAR 0.01MF 10% 200V
C816	1-124-907-11	ELECT 10MF 20% 50V

N

Les composants identifiés par une trame et par une marque Δ sont d'une importance critique pour la sécurité. Ne les remplacer que par des pièces de numéro spécifié.

The components identified by shading and mark Δ are critical for safety. Replace only with part number specified.

REF. NO.	PART NO.	DESCRIPTION	REMARK	REF. NO.	PART NO.	DESCRIPTION	REMARK
C817	1-124-119-00	ELECT	330MF	20%	16V		
C818	1-102-824-00	CERAMIC	470PF	5%	50V		
C819	1-124-907-11	ELECT	10MF	20%	50V		
C820	1-124-907-11	ELECT	10MF	20%	50V		
C821	1-124-907-11	ELECT	10MF	20%	50V		
C822	1-124-034-51	ELECT	33MF	20%	16V		
C823	1-124-907-11	ELECT	10MF	20%	50V		
C824	1-124-034-51	ELECT	33MF	20%	16V		
C825	1-124-034-51	ELECT	33MF	20%	16V		
C826	1-124-907-11	ELECT	10MF	20%	50V		
C827	1-124-907-11	ELECT	10MF	20%	50V		
C828	1-124-907-11	ELECT	10MF	20%	50V		
C829	1-124-034-51	ELECT	33MF	20%	16V		
C830	1-124-907-11	ELECT	10MF	20%	50V		
C831	1-106-220-00	MYLAR	0.1MF	10%	100V		
C832	1-124-907-11	ELECT	10MF	20%	50V		
C833	1-124-916-11	ELECT	22MF	20%	50V		
C834	1-130-487-00	MYLAR	0.022MF	5%	50V		
C835	1-124-927-11	ELECT	4.7MF	20%	50V		
C836	1-130-475-00	MYLAR	0.0022MF	5%	50V		
C837	1-136-169-00	FILM	0.22MF	5%	50V		
C838	1-130-475-00	MYLAR	0.0022MF	5%	50V		
C839	1-102-106-00	CERAMIC	100PF	10%	50V		
C840	Δ 1-136-807-11	FILM	0.018MF	3%	1.6KV		
C841	1-136-729-11	FILM	1.5MF	5%	400V		
C842	1-130-471-00	MYLAR	0.001MF	5%	50V		
C850	1-136-169-00	FILM	0.22MF	5%	50V		
C851	1-124-907-11	ELECT	10MF	20%	50V		
C852	1-124-907-11	ELECT	10MF	20%	50V		
C853	1-106-220-00	MYLAR	0.1MF	10%	100V		
C854	1-126-329-11	ELECT	470MF	20%	50V		
C855	1-124-514-11	ELECT	100MF	20%	50V		
C856	1-162-114-00	CERAMIC	0.0047MF		2KV		
C858	1-124-119-00	ELECT	330MF	20%	16V		
C888	1-124-903-11	ELECT	1MF	20%	50V		
<DIODE>							
D801	8-719-928-08	DIODE	ERD28-08S				
D802	8-719-300-80	DIODE	RU-1C				
D803	8-719-109-85	DIODE	RD5.1ESB2				
D804	8-719-911-19	DIODE	1SS119				
D805	8-719-911-19	DIODE	1SS119				
D806	8-719-109-85	DIODE	RD5.1ESB2				
D807	8-719-109-85	DIODE	RD5.1ESB2				
D808	8-719-911-19	DIODE	1SS119				
D809	8-719-911-19	DIODE	1SS119				
D810	8-719-911-19	DIODE	1SS119				
D811	8-719-109-85	DIODE	RD5.1ESB2				
D812	8-719-911-19	DIODE	1SS119				
D813	8-719-911-19	DIODE	1SS119				
D814	8-719-911-19	DIODE	1SS119				
D815	8-719-110-36	DIODE	RD13ESB2				
D817	8-719-945-80	DIODE	ERC06-15S				
D820	8-719-911-19	DIODE	1SS119				
D850	8-719-109-71	DIODE	RD3.9ESB1				
D851	Δ 8-719-903-09	DIODE	V30N				
D852	8-719-911-19	DIODE	1SS119				
D853	Δ 8-719-903-09	DIODE	V30N				
D891	8-719-110-49	DIODE	RD18ESB2				
D892	8-719-110-49	DIODE	RD18ESB2				
<IC>							
IC801	8-759-231-58	IC	TA7812S				
IC802	8-759-103-93	IC	UPC393C				
IC803	8-759-503-91	IC	TL082ACP				
IC804	8-759-103-93	IC	UPC393C				
IC805	8-759-100-75	IC	UPC1394C				
<COIL>							
L801	1-459-862-11	COIL, CHOKE	90UH				
L802	1-424-603-11	COIL, CHOKE	1.05MMH				
L803	1-459-313-00	COIL WITH CORE	(HWC)				
L804	1-410-482-31	INDUCTOR	100UH				
L805	Δ 1-424-603-11	COIL, CHOKE	1.05MMH				
<CONNECTOR>							
N-1	1-506-348-99	PIN, CONNECTOR	3P				
N-2	*1-564-508-11	PLUG, CONNECTOR	5P				
N-3	1-508-766-00	PIN, CONNECTOR	(5MM PITCH) 4P				
N-4	*1-564-507-11	PLUG, CONNECTOR	4P				
N-5	*1-564-508-11	PLUG, CONNECTOR	5P				
N-6	1-508-786-00	PIN, CONNECTOR	(5MM PITCH) 2P				
N-7	1-508-765-00	PIN, CONNECTOR	(5MM PITCH) 3P				
N-8	1-508-766-00	PIN, CONNECTOR	(5MM PITCH) 4P				
N-9	1-506-348-99	PIN, CONNECTOR	3P				
N-10	*1-564-511-11	PLUG, CONNECTOR	8P				
N-20	*1-560-126-00	PLUG, CONNECTOR	(2.5MM) 6P				
N-21	*1-560-123-00	PLUG, CONNECTOR	(2.5MM) 3P				
N-30	1-508-784-00	PIN, CONNECTOR	(5MM PITCH) 1P				
N-851	*1-506-371-00	PIN, CONNECTOR	2P				
N-853	*1-506-371-00	PIN, CONNECTOR	2P				
<NEON LAMP>							
NL801	1-519-108-99	LAMP, NEON					
<TRANSISTOR>							
Q801	Δ 8-729-201-61	TRANSISTOR	2SC2555-1				
Q802	8-729-119-80	TRANSISTOR	2SC2688-LK				
Q803	8-729-119-76	TRANSISTOR	2SA1175-HFE				
Q804	8-729-119-78	TRANSISTOR	2SC2785-HFE				
Q805	8-729-119-78	TRANSISTOR	2SC2785-HFE				
Q806	8-729-119-80	TRANSISTOR	2SC2688-LK				
Q807	8-729-119-78	TRANSISTOR	2SC2785-HFE				
Q808	8-729-119-78	TRANSISTOR	2SC2785-HFE				
Q809	8-729-119-76	TRANSISTOR	2SA1175-HFE				
Q811	Δ 8-729-805-07	TRANSISTOR	2SD1887-CA				
Q820	8-729-119-76	TRANSISTOR	2SA1175-HFE				
Q851	8-729-119-78	TRANSISTOR	2SC2785-HFE				
Q852	8-729-119-78	TRANSISTOR	2SC2785-HFE				
Q853	8-729-823-81	TRANSISTOR	2SC4632-CB7				
<RESISTOR>							
R801	Δ 1-216-378-91	METAL OXIDE	5.6	5%	2W	F	
R802	Δ 1-215-926-91	METAL OXIDE	33K	5%	3W	F	
R803	Δ 1-215-926-91	METAL OXIDE	33K	5%	3W	F	
R804	1-249-429-11	CARBON	10K	5%	1/4W		
R805	1-249-423-11	CARBON	3.3K	5%	1/4W		
R806	1-249-425-11	CARBON	4.7K	5%	1/4W		
R807	1-249-441-11	CARBON	100K	5%	1/4W		
R808	1-249-417-11	CARBON	1K	5%	1/4W		
R809	1-249-417-11	CARBON	1K	5%	1/4W		
R810	1-249-441-11	CARBON	100K	5%	1/4W		

The components identified by shading and mark Δ are critical for safety. Replace only with part number specified.

Les composants identifiés par une trame et une marque Δ sont critiques pour la sécurité. Ne les remplacer que par une pièce portant le numéro spécifié.



REF. NO.	PART NO.	DESCRIPTION	REMARK	REF. NO.	PART NO.	DESCRIPTION	REMARK
R811	1-249-421-11	CARBON	2.2K 5% 1/4W	R875	1-249-421-11	CARBON	2.2K 5% 1/4W
R812	1-249-420-11	CARBON	1.8K 5% 1/4W	R876	1-215-426-00	METAL	1.6K 1% 1/4W
R813	Δ 1-215-921-91	METAL OXIDE	4.7K 5% 3W	R877	1-249-435-11	CARBON	33K 5% 1/4W
R814	1-249-409-11	CARBON	220 5% 1/4W	R878	1-249-441-11	CARBON	100K 5% 1/4W
R815	1-249-415-11	CARBON	680 5% 1/4W	R879	Δ 1-216-489-91	METAL OXIDE	27K 5% 3W
R816	1-214-777-00	METAL	100K 1% 1/4W	R880	1-249-429-11	CARBON	10K 5% 1/4W
R817	1-215-471-00	METAL	120K 1% 1/4W	R881	1-214-761-00	METAL	22K 1% 1/4W
R818	1-215-471-00	METAL	120K 1% 1/4W	R882	1-249-433-11	CARBON	22K 5% 1/4W
R819	1-215-450-00	METAL	16K 1% 1/4W	R883	1-249-417-11	CARBON	1K 5% 1/4W
R820	1-215-451-00	METAL	18K 1% 1/4W	R884	Δ 1-215-894-91	METAL OXIDE	2.2K 5% 2W
R821	1-249-423-11	CARBON	3.3K 5% 1/4W	R885	1-249-438-11	CARBON	56K 5% 1/4W
R822	1-249-433-11	CARBON	22K 5% 1/4W	R886	1-249-414-11	CARBON	560 5% 1/4W
R823	1-249-429-11	CARBON	10K 5% 1/4W	R887	1-215-397-00	METAL	100 1% 1/4W
R824	1-215-469-00	METAL	100K 1% 1/4W	R888	1-249-410-11	CARBON	270 5% 1/4W
R825	1-215-453-00	METAL	22K 1% 1/4W	R889	1-249-417-11	CARBON	1K 5% 1/4W
R826	1-214-962-00	METAL	820K 1% 1/4W	R890	1-249-417-11	CARBON	1K 5% 1/4W
R827	1-214-764-00	METAL	30K 1% 1/4W	R891	Δ 1-216-489-91	METAL OXIDE	27K 5% 3W
R828	1-215-455-00	METAL	27K 1% 1/4W	R892	1-249-417-11	CARBON	1K 5% 1/4W
R829	1-215-455-00	METAL	27K 1% 1/4W	R893	1-215-453-00	METAL	22K 1% 1/4W
R830	Δ 1-215-928-91	METAL OXIDE	68K 5% 3W	R894	1-249-401-11	CARBON	47 5% 1/4W
R831	Δ 1-215-928-91	METAL OXIDE	68K 5% 3W	R895	1-202-731-00	SOLID	10M 20% 1/2W
R832	1-249-417-11	CARBON	1K 5% 1/4W	R896	1-260-111-11	CARBON	10K 5% 1/2W
R833	1-249-419-11	CARBON	1.5K 5% 1/4W	R903	1-247-735-11	SOLID	47 20% 1/2W
R834	1-249-419-11	CARBON	1.5K 5% 1/4W	R904	Δ 1-215-928-91	METAL OXIDE	68K 5% 3W
R835	1-215-429-00	METAL	2.2K 1% 1/4W	R905	Δ 1-215-911-91	METAL OXIDE	100 5% 3W
R836	1-215-435-00	METAL	3.9K 1% 1/4W	<SPARK GAP>			
R837	1-249-433-11	CARBON	22K 5% 1/4W	SG801	1-519-422-11	GAP, SPARK	
R838	1-249-435-11	CARBON	33K 5% 1/4W	<TRANSFORMER>			
R839	1-249-438-11	CARBON	56K 5% 1/4W	T801	Δ 1-437-078-11	TRANSFORMER, HORIZONTAL DRIVE	
R840	1-249-434-11	CARBON	27K 5% 1/4W	T802	1-437-090-00	HDT	
R841	1-249-429-11	CARBON	10K 5% 1/4W	T803	Δ 1-453-121-11	TRANSFORMER ASSY, FLYBACK (NX-2630B4)	
R842	1-249-435-11	CARBON	33K 5% 1/4W	*****			
R843	1-249-423-11	CARBON	3.3K 5% 1/4W	*A-1394-421-A	S BOARD, COMPLETE		
R844	1-249-433-11	CARBON	22K 5% 1/4W	*****			
R845	1-249-435-11	CARBON	33K 5% 1/4W	*4-033-528-01	CASE (UPPER LID), SHIELD, P4		
R846	1-249-429-11	CARBON	10K 5% 1/4W	<CAPACITOR>			
R847	1-214-761-00	METAL	22K 1% 1/4W	C3403	1-164-161-11	CERAMIC CHIP	0.0022MF 10% 50V
R848	1-215-429-00	METAL	2.2K 1% 1/4W	C3408	1-164-232-11	CERAMIC CHIP	0.01MF 10% 50V
R849	1-215-421-00	METAL	1K 1% 1/4W	C3409	1-124-589-11	ELECT	47MF 20% 16V
R850	1-215-429-00	METAL	2.2K 1% 1/4W	C3411	1-124-034-51	ELECT	33MF 20% 16V
R851	1-215-404-00	METAL	200 1% 1/4W	C3442	1-164-161-11	CERAMIC CHIP	0.0022MF 10% 50V
\boxtimes R852	Δ 1-215-469-00	METAL	100K 1% 1/4W	C3446	1-163-129-00	CERAMIC CHIP	330PF 5% 50V
R853	1-215-469-00	METAL	100K 1% 1/4W	C3447	1-163-117-00	CERAMIC CHIP	100PF 5% 50V
R854	1-249-430-11	CARBON	12K 5% 1/4W	C3448	1-164-232-11	CERAMIC CHIP	0.01MF 10% 50V
R855	1-215-469-00	METAL	100K 1% 1/4W	C3449	1-164-182-11	CERAMIC CHIP	0.0033MF 10% 50V
R856	1-249-430-11	CARBON	12K 5% 1/4W	C3451	1-164-004-11	CERAMIC CHIP	0.1MF 10% 25V
R857	1-249-433-11	CARBON	22K 5% 1/4W	C3452	1-163-989-11	CERAMIC CHIP	0.033MF 10% 25V
R858	1-249-413-11	CARBON	470 5% 1/4W	C3453	1-124-589-11	ELECT	47MF 20% 16V
R859	1-249-435-11	CARBON	33K 5% 1/4W	C3454	1-126-162-11	ELECT	3.3MF 20% 50V
R860	1-249-441-11	CARBON	100K 5% 1/4W	C3455	1-126-163-11	ELECT	4.7MF 20% 16V
R861	1-249-421-11	CARBON	2.2K 5% 1/4W	C3456	1-163-129-00	CERAMIC CHIP	330PF 5% 50V
R862	1-249-434-11	CARBON	27K 5% 1/4W	C3457	1-163-117-00	CERAMIC CHIP	100PF 5% 50V
R863	1-249-431-11	CARBON	15K 5% 1/4W	C3460	1-163-099-00	CERAMIC CHIP	18PF 5% 50V
R864	1-249-428-11	CARBON	8.2K 5% 1/4W	C3461	1-163-099-00	CERAMIC CHIP	18PF 5% 50V
R865	1-249-440-11	CARBON	82K 5% 1/4W	C3507	1-164-232-11	CERAMIC CHIP	0.01MF 10% 50V
R866	1-249-436-11	CARBON	39K 5% 1/4W				
R867	1-249-437-11	CARBON	47K 5% 1/4W				
R868	1-249-428-11	CARBON	8.2K 5% 1/4W				
R869	1-249-429-11	CARBON	10K 5% 1/4W				
R870	1-249-417-11	CARBON	1K 5% 1/4W				
R871	1-249-440-11	CARBON	82K 5% 1/4W				
R872	1-249-423-11	CARBON	3.3K 5% 1/4W				
R873	1-249-441-11	CARBON	100K 5% 1/4W				
R874	1-249-435-11	CARBON	33K 5% 1/4W				

• The components identified by \boxtimes in this manual have been carefully factory-selected for each set in order to satisfy regulations regarding X-ray radiation. Should replacement be required, replace only with the value originally used.
• * : Selected to yield optimum performance.



REF. NO.	PART NO.	DESCRIPTION	REMARK	REF. NO.	PART NO.	DESCRIPTION	REMARK
C1049	1-124-598-11	ELECT 22MF	20% 25V	R1016	1-249-441-11	CARBON 100K 5%	1/4W
C1051	1-124-465-00	ELECT 0.47MF	20% 50V	R1017	1-247-807-31	CARBON 100 5%	1/4W
C1055	1-124-589-11	ELECT 47MF	20% 16V	R1018	1-249-427-11	CARBON 6.8K 5%	1/4W
C1056	1-124-499-11	ELECT 1MF	20% 50V	R1019	1-249-427-11	CARBON 6.8K 5%	1/4W
C1057	1-124-768-11	ELECT 4.7MF	20% 50V	R1023	1-247-807-31	CARBON 100 5%	1/4W
C1059	1-124-499-11	ELECT 1MF	20% 50V	R1026	1-249-425-11	CARBON 4.7K 5%	1/4W
C1060	1-124-499-11	ELECT 1MF	20% 50V	R1028	1-249-434-11	CARBON 27K 5%	1/4W
C1061	1-124-499-11	ELECT 1MF	20% 50V	R1029	1-249-435-11	CARBON 33K 5%	1/4W
C1062	1-102-129-00	CERAMIC 0.01MF	10% 50V	R1030	1-249-417-11	CARBON 1K 5%	1/4W
C1063	1-124-768-11	ELECT 4.7MF	20% 50V	R1032	1-249-417-11	CARBON 1K 5%	1/4W
C1066	1-126-101-11	ELECT 100MF	20% 16V	R1033	1-249-393-11	CARBON 10 5%	1/4W F
		<DIODE>		R1034	1-249-417-11	CARBON 1K 5%	1/4W
D1005	8-719-110-36	DIODE RD13ESB2		R1036	1-247-883-00	CARBON 150K 5%	1/4W
D1009	8-719-110-36	DIODE RD13ESB2		R1037	1-247-883-00	CARBON 150K 5%	1/4W
D1010	8-719-110-36	DIODE RD13ESB2		R1038	1-247-883-00	CARBON 150K 5%	1/4W
D1011	8-719-110-36	DIODE RD13ESB2		R1043	1-249-417-11	CARBON 1K 5%	1/4W
D1012	8-719-110-36	DIODE RD13ESB2		R1046	1-249-413-11	CARBON 470 5%	1/4W
D1013	8-719-110-36	DIODE RD13ESB2		R1048	1-247-807-31	CARBON 100 5%	1/4W
D1017	8-719-110-36	DIODE RD13ESB2		R1050	1-247-807-31	CARBON 100 5%	1/4W
D1018	8-719-110-36	DIODE RD13ESB2		R1051	1-249-417-11	CARBON 1K 5%	1/4W
D1019	8-719-110-36	DIODE RD13ESB2		R1052	1-249-413-11	CARBON 470 5%	1/4W
D1020	8-719-109-66	DIODE RD3.3ESB2		R1054	1-247-807-31	CARBON 100 5%	1/4W
D1021	8-719-109-66	DIODE RD3.3ESB2		R1055	1-249-413-11	CARBON 470 5%	1/4W
D1022	8-719-109-66	DIODE RD3.3ESB2		R1056	1-247-807-31	CARBON 100 5%	1/4W
		<IC>		R1057	1-249-441-11	CARBON 100K 5%	1/4W
IC1002	8-752-067-28	IC CXA1545AS		R1059	1-247-807-31	CARBON 100 5%	1/4W
IC1011	8-759-145-57	IC UPC4557C		R1061	1-249-409-11	CARBON 220 5%	1/4W
		<COIL>		R1062	1-249-441-11	CARBON 100K 5%	1/4W
L1001	1-408-422-00	INDUCTOR 120UH		R1063	1-249-409-11	CARBON 220 5%	1/4W
L1002	1-408-422-00	INDUCTOR 120UH		R1066	1-215-437-00	METAL 4.7K 1%	1/4W
		<TRANSISTOR>		R1067	1-215-437-00	METAL 4.7K 1%	1/4W
Q1009	8-729-119-78	TRANSISTOR 2SC2785-HFE		R1068	1-215-437-00	METAL 4.7K 1%	1/4W
Q1010	8-729-119-78	TRANSISTOR 2SC2785-HFE		R1069	1-215-437-00	METAL 4.7K 1%	1/4W
Q1016	8-729-119-76	TRANSISTOR 2SA1175-HFE		R1070	1-249-411-11	CARBON 330 5%	1/4W
Q1017	8-729-119-76	TRANSISTOR 2SA1175-HFE		R1071	1-249-431-11	CARBON 15K 5%	1/4W
Q1018	8-729-141-26	TRANSISTOR 2SC3622A-LK		R1073	1-249-431-11	CARBON 15K 5%	1/4W
Q1019	8-729-119-76	TRANSISTOR 2SA1175-HFE		R1077	1-249-418-11	CARBON 1.2K 5%	1/4W
Q1020	8-729-119-76	TRANSISTOR 2SA1175-HFE		R1078	1-249-418-11	CARBON 1.2K 5%	1/4W
Q1021	8-729-119-76	TRANSISTOR 2SA1175-HFE		R1079	1-247-807-31	CARBON 100 5%	1/4W
Q1022	8-729-141-26	TRANSISTOR 2SC3622A-LK		R1080	1-215-423-00	METAL 1.2K 1%	1/4W
Q1023	8-729-119-78	TRANSISTOR 2SC2785-HFE		R1081	1-215-421-00	METAL 1K 1%	1/4W
Q1029	8-729-119-76	TRANSISTOR 2SA1175-HFE		R1089	1-247-807-31	CARBON 100 5%	1/4W
Q1030	8-729-119-78	TRANSISTOR 2SC2785-HFE		R1094	1-247-807-31	CARBON 100 5%	1/4W
Q1031	8-729-119-78	TRANSISTOR 2SC2785-HFE		R1096	1-247-807-31	CARBON 100 5%	1/4W
Q1032	8-729-119-76	TRANSISTOR 2SA1175-HFE		R1099	1-249-413-11	CARBON 470 5%	1/4W
Q1033	8-729-119-76	TRANSISTOR 2SA1175-HFE		R1110	1-247-807-31	CARBON 100 5%	1/4W
Q1034	8-729-119-76	TRANSISTOR 2SA1175-HFE		R1116	1-249-441-11	CARBON 100K 5%	1/4W
		<RESISTOR>		R1118	1-249-413-11	CARBON 470 5%	1/4W
R1011	1-249-435-11	CARBON 33K 5%	1/4W	R1120	1-249-413-11	CARBON 470 5%	1/4W
R1012	1-249-434-11	CARBON 27K 5%	1/4W	R1121	1-249-441-11	CARBON 100K 5%	1/4W
R1013	1-249-417-11	CARBON 1K 5%	1/4W	R1122	1-249-413-11	CARBON 470 5%	1/4W
R1014	1-249-441-11	CARBON 100K 5%	1/4W	R1133	1-247-807-31	CARBON 100 5%	1/4W
R1015	1-249-425-11	CARBON 4.7K 5%	1/4W	R1134	1-247-807-31	CARBON 100 5%	1/4W
				R1137	1-249-411-11	CARBON 330 5%	1/4W
				R1138	1-249-415-11	CARBON 680 5%	1/4W
				R1139	1-249-413-11	CARBON 470 5%	1/4W
				R1140	1-249-413-11	CARBON 470 5%	1/4W
				R1141	1-249-413-11	CARBON 470 5%	1/4W
				R1142	1-249-415-11	CARBON 680 5%	1/4W
				R1147	1-247-807-31	CARBON 100 5%	1/4W
				R1148	1-247-807-31	CARBON 100 5%	1/4W
				R1149	1-249-417-11	CARBON 1K 5%	1/4W
				R1150	1-247-807-31	CARBON 100 5%	1/4W
				R1151	1-247-807-31	CARBON 100 5%	1/4W



Les composants identifiés par une trame et par une marque Δ sont d'une importance critique pour la sécurité. Ne les remplacer que par des pièces de numéro spécifié.

The components identified by shading and mark Δ are critical for safety. Replace only with part number specified.

REF. NO.	PART NO.	DESCRIPTION	REMARK
R1152	1-249-417-11	CARBON 1K 5% 1/4W	
<CONNECTOR>			
U-12	1-573-300-21	CONNECTOR, BOARD TO BOARD 18P	
U-13	1-573-300-21	CONNECTOR, BOARD TO BOARD 18P	
U-16	*1-564-513-11	PLUG, CONNECTOR 10P	
U-22	*1-565-930-11	CONNECTOR (RECEPTACLE) 30P	
U-23	*1-566-367-11	CONNECTOR, HINGE (RECEPTACLE)	
U-32	*1-564-510-11	PLUG, CONNECTOR 7P	
U-47	*1-564-506-11	PLUG, CONNECTOR 3P	

*A-1394-434-A UT BOARD, COMPLETE

<CAPACITOR>						
C1152	1-102-074-00	CERAMIC	0.001MF	10%	50V	
C1153	1-164-096-11	CERAMIC	0.01MF		50V	
C1154	1-164-096-11	CERAMIC	0.01MF		50V	
C1155	1-126-103-11	ELECT	470MF	20%	16V	
C1158	1-124-598-11	ELECT	22MF	20%	25V	
C1159	1-124-598-11	ELECT	22MF	20%	25V	
C1160	1-124-598-11	ELECT	22MF	20%	25V	
C1161	1-124-598-11	ELECT	22MF	20%	25V	
C1164	1-126-103-11	ELECT	470MF	20%	16V	
C1165	1-126-301-11	ELECT	1MF	20%	50V	
C1166	1-126-301-11	ELECT	1MF	20%	50V	
C1167	1-126-301-11	ELECT	1MF	20%	50V	
C1168	1-126-301-11	ELECT	1MF	20%	50V	
C1199	1-102-129-00	CERAMIC	0.01MF	10%	50V	
C1200	1-102-129-00	CERAMIC	0.01MF	10%	50V	

<DIODE>			
D1151	8-719-110-36	DIODE RD13ESB2	
D1152	8-719-110-36	DIODE RD13ESB2	
D1158	8-719-110-36	DIODE RD13ESB2	
D1159	8-719-110-36	DIODE RD13ESB2	
D1160	8-719-110-36	DIODE RD13ESB2	
D1161	8-719-110-36	DIODE RD13ESB2	
D1162	8-719-110-36	DIODE RD13ESB2	
D1163	8-719-110-36	DIODE RD13ESB2	
D1164	8-719-110-36	DIODE RD13ESB2	
D1165	8-719-110-36	DIODE RD13ESB2	
D1166	8-719-110-36	DIODE RD13ESB2	
D1167	8-719-110-36	DIODE RD13ESB2	
D1168	8-719-110-36	DIODE RD13ESB2	
D1169	8-719-110-36	DIODE RD13ESB2	
D1170	8-719-110-36	DIODE RD13ESB2	
D1171	8-719-110-36	DIODE RD13ESB2	

<JACK>			
J1001	1-537-188-11	TERMINAL, PUSH (8P)	
J1003	1-573-970-11	BLOCK, (S) TERMINAL	
J1004	1-695-304-11	TERMINAL BLOCK, S	
J1005	1-695-054-11	JACK BLOCK, PIN	
J1006	1-573-970-11	BLOCK, (S) TERMINAL	
J1007	1-573-969-11	JACK BLOCK, PIN	
J1008	1-573-969-11	JACK BLOCK, PIN	

REF. NO.	PART NO.	DESCRIPTION	REMARK
<RESISTOR>			
R1153	1-249-403-11	CARBON 68 5% 1/4W	
R1154	1-249-429-11	CARBON 10K 5% 1/4W	
R1158	1-247-804-11	CARBON 75 5% 1/4W	
R1164	1-247-895-00	CARBON 470K 5% 1/4W	
R1165	1-247-895-00	CARBON 470K 5% 1/4W	
R1166	1-247-895-00	CARBON 470K 5% 1/4W	
R1167	1-247-895-00	CARBON 470K 5% 1/4W	
R1168	1-247-895-00	CARBON 470K 5% 1/4W	
R1169	1-249-403-11	CARBON 68 5% 1/4W	
R1170	1-249-403-11	CARBON 68 5% 1/4W	
R1171	1-247-895-00	CARBON 470K 5% 1/4W	
R1172	1-247-895-00	CARBON 470K 5% 1/4W	
R1173	1-247-804-11	CARBON 75 5% 1/4W	
R1174	1-247-895-00	CARBON 470K 5% 1/4W	
R1175	1-247-895-00	CARBON 470K 5% 1/4W	
R1176	1-247-804-11	CARBON 75 5% 1/4W	
R1177	1-247-804-11	CARBON 75 5% 1/4W	
R1178	1-247-895-00	CARBON 470K 5% 1/4W	
R1179	1-247-895-00	CARBON 470K 5% 1/4W	
R1180	1-247-804-11	CARBON 75 5% 1/4W	
R1181	1-247-804-11	CARBON 75 5% 1/4W	
R1182	1-247-804-11	CARBON 75 5% 1/4W	
R1183	1-247-895-00	CARBON 470K 5% 1/4W	
R1184	1-247-895-00	CARBON 470K 5% 1/4W	
R1185	1-247-895-00	CARBON 470K 5% 1/4W	
R1186	1-247-895-00	CARBON 470K 5% 1/4W	
R1187	1-247-804-11	CARBON 75 5% 1/4W	
R1188	1-247-804-11	CARBON 75 5% 1/4W	
R1191	1-249-425-11	CARBON 4.7K 5% 1/4W	
R1192	1-249-425-11	CARBON 4.7K 5% 1/4W	
R1193	1-249-425-11	CARBON 4.7K 5% 1/4W	
R1194	1-249-425-11	CARBON 4.7K 5% 1/4W	
R1195	1-249-429-11	CARBON 10K 5% 1/4W	
R1196	1-249-429-11	CARBON 10K 5% 1/4W	

<SWITCH>		
S1150	1-572-198-11	SWITCH, KEYBOARD

<CONNECTOR>		
UT9	*1-564-517-11	PLUG, CONNECTOR 2P
UT11	*1-564-519-11	PLUG, CONNECTOR 4P
UT22	*1-565-928-11	CONNECTOR (TUB) 30P
UT23	*1-566-641-11	CONNECTOR, HINGE (TAB) 18P
UT35	*1-564-518-11	PLUG, CONNECTOR 3P
UT38	1-564-517-11	PLUG, CONNECTOR 2P

MISCELLANEOUS

Δ 1-241-744-11	RESISTOR ASSY (HIGH-VOLTAGE)
1-417-178-11	SELECTOR, ANTENNA (AS-2)
Δ 1-451-396-21	DEFLECTION YOKE (Y936PA)
Δ 1-452-443-13	NECK ASSY, PICTURE TUBE (NA367)
Δ 1-453-108-11	DC BLOCK, HIGH-VOLTAGE
1-504-141-11	SPEAKER (13CM) (KP-46XBR35/53XBR35(U/C))
1-504-312-11	SPEAKER (SQUAWKER) (5CM) (KP-61XBR38)
1-504-313-11	SPEAKER (16CM) (KP-61XBR38)
1-544-580-21	SPEAKER (2.5CM) (KP-46XBR35/53XBR35(U/C))
*1-555-400-00	CABLE, PIN

The components identified by shading and mark **△** are critical for safety.
Replace only with part number specified.

Les composants identifiés par une trame et par une marque **△** sont d'une importance critique pour la sécurité. Ne les remplacer que par des pièces de numéro spécifié.

REF. NO.	PART NO.	DESCRIPTION	REMARK
	*1-557-056-31	CABLE, P-P	
	△ 1-696-002-12	CORD, POWER(WITH NOISE FILTER) 7.0A/125V	
	△ 8-736-634-05	PICTURE TUBE 07MK3(G)	
	△ 8-736-635-05	PICTURE TUBE 07MK3(B) (KP-46XBR35/53XBR35(U/C))	
	△ 8-736-636-05	PICTURE TUBE 07MK3(R) (KP-46XBR35/53XBR35(U/C))	
	△ 8-736-640-05	PICTURE TUBE 07MK2(B) (KP-61XBR38)	
	△ 8-736-641-05	PICTURE TUBE 07MK2(R) (KP-61XBR38)	
☒ R900	△	METAL	1/4W
☒ R901	△	METAL	1/4W
☒ R902	△	METAL	1/4W

T7201**△** 1-423-311-21 TRANSFORMER, POWER

ACCESSORIES AND PACKING MATERIALS

- 3-758-548-21 MANUAL, INSTRUCTION (ENGLISH)
(KP-46XBR35/53XBR35(U/C)/61XBR38)
- 3-758-548-31 MANUAL, INSTRUCTION (FRENCH)
(KP-53XBR35(CND))
- 3-758-548-41 MANUAL, INSTRUCTION (SPANISH)
(KP-46XBR35/53XBR35(US)/61XBR38)
- *4-030-895-01 JOINT
- *4-037-320-01 CUSHION (UPPER) (ASSY) (KP-53XBR35(U/C))
- *4-037-670-01 CUSHION (UPPER) (ASSY) (KP-46XBR35)
- *4-040-904-01 CUSHION (UPPER) (ASSY) (KP-61XBR38)
- *4-037-321-01 CUSHION (LOWER) (ASSY) (KP-53XBR35(U/C))
- *4-037-671-01 CUSHION (LOWER) (ASSY) (KP-46XBR35)
- *4-040-905-01 CUSHION (LOWER) (ASSY) (KP-61XBR38)
- *4-037-326-01 INDIVIDUAL CARTON (KP-53XBR35(U/C))
- *4-037-672-01 INDIVIDUAL CARTON (KP-46XBR35)
- *4-040-907-02 INDIVIDUAL CARTON (KP-61XBR38)
- *4-037-327-01 TRAY (KP-53XBR35(U/C))
- *4-037-671-01 TRAY (KP-46XBR35)
- *4-040-906-01 TRAY (KP-61XBR38)
- *4-037-674-01 PLATE, TOP (KP-46XBR35)
- *4-037-328-01 PLATE, TOP (KP-53XBR35(U/C))
- *4-040-111-01 PLATE, TOP (KP-61XBR38)
- *4-037-675-01 PLATE, BOTTOM (KP-46XBR35)
- *4-037-329-01 PLATE, BOTTOM (KP-53XBR35(U/C))
- *4-040-903-01 PLATE, BOTTOM (KP-61XBR38)
- *4-041-423-01 SHEET, PROTECTION (KP-46XBR35)
- *4-042-463-01 SHEET, PROTECTION (KP-53XBR35(U/C))
- *4-042-464-01 SHEET, PROTECTION (KP-61XBR38)
- *4-041-425-01 BAG, PROTECTION (KP-46XBR35)
- *4-041-426-01 BAG, PROTECTION (KP-53XBR35(U/C))
- *4-041-428-01 BAG, PROTECTION (KP-61XBR38)
- *4-039-795-02 PALLET, CUSHION (KP-53XBR35(U/C))
- *4-042-310-01 PALLET, CUSHION (KP-46XBR35)

REMOTE COMMANDER

- 1-693-156-21 REMOTE COMMANDER (RM-Y114A)
- 9-902-623-01 COVER, BATTERY (FOR RM-Y114A)
- 9-902-624-01 COVER (FOR RM-Y114A)

- The components identified by **☒** in this manual have been carefully factory-selected for each set in order to satisfy regulations regarding X-ray radiation. Should replacement be required, replace only with the value originally used.
- **※** : Selected to yield optimum performance.

